

EAST FORT MYERS REVITALIZATION & REDEVELOPMENT PLAN

May 3, 2010



EAST FORT MYERS REVITALIZATION & REDEVELOPMENT PLAN

was created by:

Fort Myers City Council

Mayor Randall P. Henderson, Jr.
Councilwoman Teresa Watkins Brown, Ward 1
Councilman Johnny Streets, Ward 2
Councilman Levon Simms, Ward 3
Councilman Michael A. Flanders, Ward 4
Councilman Forrest Banks, Ward 5
Councilman Thomas Leonardo, Ward 6
Former Mayor Jim Humphrey
Former Councilman Warren Wright, Ward 1

City of Fort Myers Staff

William P. Mitchell
City Manager

Robert Gardner, AICP, CBO
Community Development Director

Nicole DeV Vaughn, AICP
Planning Manager

Keisha Cyriaano
Senior Planner

Leigh Scrabis
Deputy Director, Fort Myers Redevelopment Agency

Enid Torregrosa
Former Historic Preservation Coordinator

Richard Calkins
GIS Analyst

Lt. William Newhouse
Fort Myers Police Department

Dover, Kohl & Partners

Victor Dover
Joseph Kohl
Margaret Flippen
James Dougherty
Andrew Georgiadis
Canan Mutlu
Elma Felix
Kenneth Garcia
Sofia Villanueva

Spikowski Planning Associates

Bill Spikowski

Lee Duffus, Ph.D.

Hall Planning & Engineering

Rick Hall
Dewayne Carver

Prather Associates, Inc.

Shaye Parther

Mary Rawl

*and Hundreds of East Fort Myers
Residents, Business and Property
Owners*



TABLE OF CONTENTS

executive summary	
research & analysis	1
creating the plan	2
demographics and survey results	3
four-point strategy	4
transportation	5
environment	6
implementation	7
appendix	A
community redevelopment act requirements	
appendix	B
wards of East Fort Myers	
appendix	C
enterprise zone brochure	
appendix	D
bi-lingual survey	



research & analysis 1

EAST FORT MYERS TODAY



Figure 1.1: The East Fort Myers study area

East Fort Myers is a distinct community made up of varied neighborhoods with historic ties to commerce. It is located midway between downtown Fort Myers and I-75, with two waterfront boundaries (the Caloosahatchee River on the north and Billy's Creek on the south and west). The study area boundary ends at Prospect Avenue (the city limits) on the east.

East Fort Myers is bisected eastward and westward by Palm Beach Boulevard and the adjacent Seminole Gulf Railroad. The road and railroad tracks create a busy corridor forming a physical barrier between neighborhoods. The area is one of the most economically and culturally diverse communities in Lee County, with a mixture of Caucasians, African-Americans, Hispanics, and others living and working here. The East Fort Myers study area has experienced both prosperity and decline throughout its storied history. Recent development pressures

along the river, coupled with increasing blight and neighborhood decline, have sparked the need for an overall strategy to guide and encourage the continued revitalization of this important part of Fort Myers. This strategy began with the 2007 "East Fort Myers Revitalization and Redevelopment Plan" (see page 1.19) and is evolving further through the process described in this report.

A wide variety of housing types are found in East Fort Myers, ranging from single-family homes on larger lots to small cottages to apartment buildings. Historic homes in the area reflect a style of building that is climate-responsive, charming, and instructive as a pattern for new development. These homes have doors and windows facing streets and public spaces, which allows for natural surveillance (also known as "eyes on the street") by neighbors. The older sections of the neighborhoods are organized in the traditional pattern of interconnected streets and blocks.

On the other hand, most of the apartment buildings built in the last fifty years were arranged on super-blocks. These development projects contain barrack-style buildings usually facing parking lots rather than streets and have large blank walls and ambiguous semi-public spaces. The areas surrounding the apartment complexes have suffered from a compromised street network and a concentration of a single housing type, causing these areas to stagnate. Natural surveillance of public spaces has been thwarted by the physical arrangement of these apartment buildings; crime and safety problems are continuing concerns.

Well-publicized homicides and robberies, often connected to the drug trade, have stigmatized the study area, even though crime rates have been dropping. East Fort Myers, like many other communities across the country, is now suffering from a severe wave of foreclosures and mortgage defaults that began during the housing market collapse and accelerated during the ensuing economic crisis. Landlords, even those who maintain their properties carefully, have recently found it difficult to find tenants, especially considering the recent “out-migration” of Mexicans and Central Americans due to the economy. There are numerous property maintenance code violations and unsafe structures, many a result of foreclosures or lack of responsible tenants. The resulting liens on properties have further contributed to a wave of abandonment, which has scared investors and individual buyers looking to purchase a primary residence.

The principal commercial corridor, Palm Beach Boulevard, connects I-75 with downtown Fort Myers and serves as one of three major gateways to the city. The corridor is lined with auto-oriented businesses; the boulevard clearly caters to motorists passing by. Sidewalks for pedestrians are narrow and incomplete and dedicated pedestrian crossings are infrequent. Many buildings are set far back from the street, with parking lots separating the businesses from the sidewalk and street. Some bus service is available, but there are many opportunities to create a healthier multi-modal corridor.

Florida DOT has recently made physical changes to Palm Beach Boulevard that enhance its role as a channel to move traffic as smoothly as possible between downtown and I-75. The redesign has added extremely long median strips which greatly reduce the ability of motorists to circulate to destinations other than those that are straight ahead on the right side. Business owners and their patrons are frustrated about the difficulty of accessing businesses. The faltering economy has clearly hurt businesses too, but there are very credible reports of significant declines in revenue have been observed since the median barriers



Figure 1.2: The entrance to the City of Fort Myers.



Figure 1.3: The increase in high-rise development downtown has led to resident concerns about the future of the riverfront in East Fort Myers.



Figure 1.4: As clean-up efforts continue, Billy's Creek can return to being the centerpiece of the community.



Figure 1.5: The Tarpon Street Pier provides public access to the Caloosahatchee River.



Figure 1.6: The Caloosahatchee River and its imperiled mangrove forest.



Figure 1.7: Poorly maintained rail lines and right-of-way.

were installed, a demonstration of how the design of the built environment can affect this community's economic health.

Several community parks – Billy Bowlegs, Riverside, and Shady Oaks – and a regional park, Terry Park, are located in East Fort Myers. These excellent parks allow for many recreational opportunities, yet the community lacks small neighborhood parks and playgrounds. The improved Tarpon Street pier provides access to the Caloosahatchee River while the continued restoration efforts at Billy's Creek provide for resident and visitor access to the waterway. While access to the water does exist, connections to these spaces need to be improved and overall safety enhanced. In addition, the time is now to plan for future public access to these waterways, especially during the current lull in development along the river and creek.

The East Fort Myers of today represents a community that has overcome many challenges and one filled with opportunity for a better future. Residents are proud of East Fort Myers and its livable qualities for those of all ethnic backgrounds and income levels. Through the coordinated efforts of city leaders, residents, employees, business owners, and investors, a rebirth of East Fort Myers is obtainable.



Figures 1.8 and 1.9: The median along Palm Beach Boulevard blocks many cross streets and access to businesses.

Though there are many areas of concern in East Fort Myers, there are also contemplative and active areas that have the potential to be the best of their kind in Southwest Florida. For example, Shady Oaks Park is a rare example of a recreational park inserted into a large mature live oak hammock. Some private lots are park-like, hosting a wide variety of plants and wildlife.

Unlike many suburban areas, East Fort Myers has a few remaining examples of its mercantile buildings. Some of the vernacular homes in East Fort Myers are among the oldest in Southwest Florida. Their climate-responsive features could be emulated by developers who are wishing to construct houses that fit with the weather patterns and culture of East Fort Myers.



Figure 1.10: East Fort Myers' main street fragment at Palm Beach Boulevard and Superior Street.



Figure 1.11: A lushly landscaped riverfront lot



Figure 1.12: Well-shaded playground at Shady Oaks Park



Figure 1.13: Reilly Brothers occupies the historic rail station.



Figure 1.14: Historic bungalow in the study area



Figure 1.15: Historic house in the study area



Figure 1.16: Riverside Park is a good example of pedestrian access to the Caloosahatchee River.

EARLY INFLUENCES ON EAST FORT MYERS

Fort Myers grew as a trading center for the surrounding cattle region when the military fort was no longer needed. Commerce and travel was primarily by water, although trails and unimproved roads were used for cattle drives and travel by animal-drawn carts. Fort Myers became the county seat of Lee County when it was formed in 1887 (Hendry and Collier Counties weren't broken out of Lee County until 1923). Settlements in this region were all located along harbors, bays, and rivers.

In the 1898 nautical chart shown to the lower right, the settlement of "Myers" (later it will again be known by its original name) is shown in the bottom center of the chart. Land that later became East Fort Myers is shown with a red dashed line. At that time the mouth of Billy's Creek, including much of Dean Park, was mainly swampland. The trail that became East First Street (later Palm Beach Boulevard) follows the current route west of Veronica Shoemaker Boulevard. The only cultivated land in 1898 was on the west side of what is now Marsh Avenue.

Dredging of the Caloosahatchee promised to make the river navigable to Lake Okeechobee and beyond, but it was a railroad that facilitated land-based access to Fort Myers. In 1904 the rail line that still bisects East Fort Myers was built by the Atlantic Coast Line, extending tracks from Bartow and Fort Ogden (south of Arcadia) that had previously ended at Punta Gorda but now crossed the Caloosahatchee at Beautiful Island. One terminal was built in Tice, the other at Main and Monroe Streets in what is now downtown Fort Myers. This railroad carried passengers but its tracks also ran out to packing houses built on pilings over the river where vegetables, oranges, and grapefruit came in by steam boat and could now be switched to rail for transport to northern markets.

With railroad access, Fort Myers had for the first time a fast and dependable transportation network inside and outside the city, causing an immediate building and agricultural boom. Within five years, however, automobiles also began to appear in Fort Myers. During the 1920s many roads were paved, allowing automobiles to begin replacing rail transportation after only two decades of dominance by trains. Then as now, the means of transportation had a profound impact on the economy and vitality of towns and regions.

* Illustration credits can be found on page 1.28.



* Figure 1.17: Steamboat access to Fort Myers in 1901 ¹



Figure 1.18: *Fort Myers Press*, February 11, 1904 ²

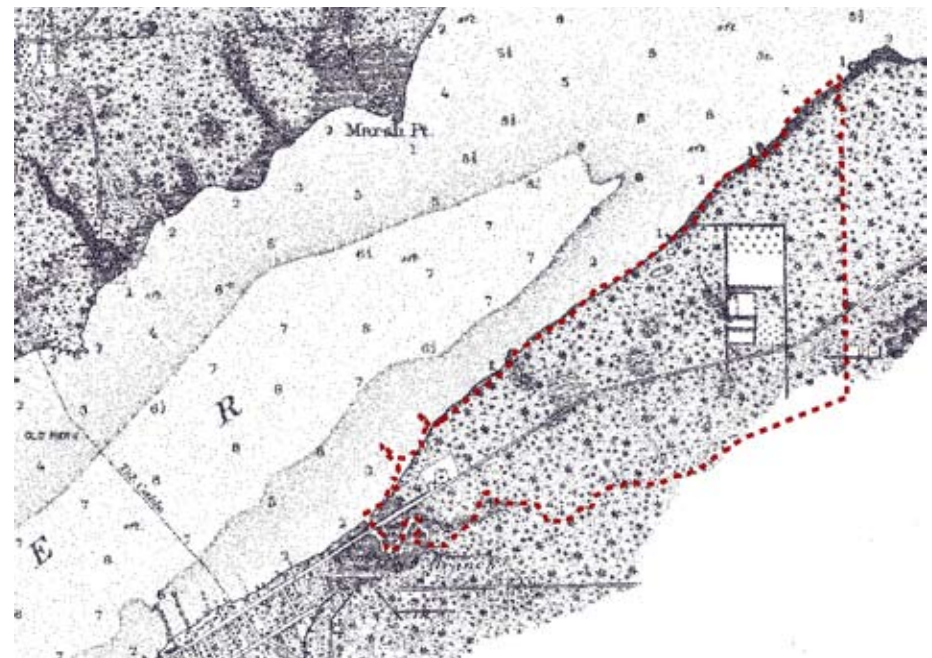

Figure 1.19: Nautical chart from 1898, with East Fort Myers study area outlined in red ³

Although East First Street did not connect to Palm Beach on the east coast of Florida until 1923, it was the main automobile route leading east from Fort Myers much earlier. East First Street became the site of most commerce in East Fort Myers because it ran parallel to the railroad and was able to serve both transportation routes and the daily needs of local residents. The new Edgewood subdivision had a handsome entrance at the corner of Superior Street and East First Street as shown in the 1912 photograph to the right.

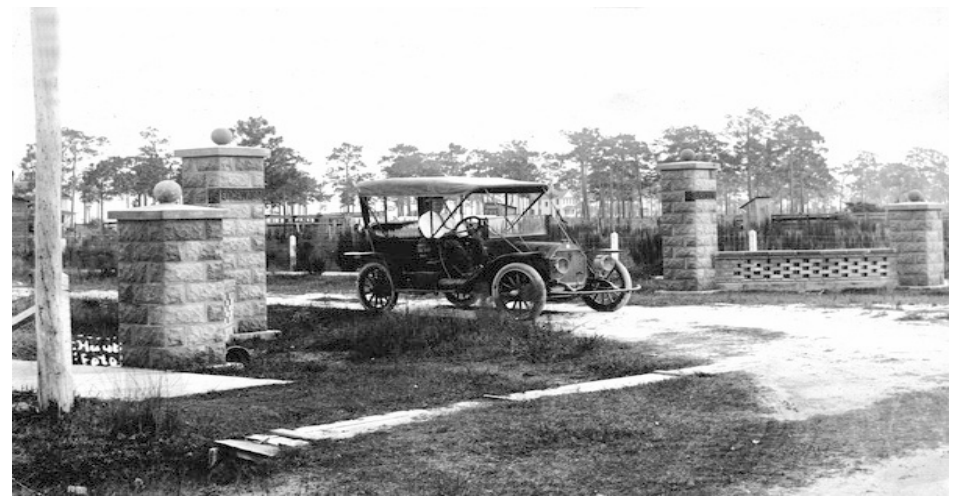

Figure 1.20: Entrance to Edgewood subdivision in 1912 ⁴



Figure 1.21: Sanborn fire insurance map for East Fort Myers, 1917. ⁵ Buildings are shown in yellow. The main road is identified as “Lee County Boulevard” although that name was rarely used.

THE TAMIAMI TRAIL CROSSES THE RIVER IN EAST FORT MYERS

As the Tamiami Trail was being constructed to connect Tampa and Miami, there was much contention as to where it would cross the Caloosahatchee. Private parties began building a 16-foot-wide wooden bridge northward from Fremont Street in 1923. The venture was acquired by Lee County and opened in 1924 as a free bridge to meet federal requirements for the Tamiami Trail.

The location of this bridge was curious, being 1½ miles east of downtown Fort Myers, but it was part of a concerted effort by local boosters to move the center of commerce and wealth to East Fort Myers. This dream never came true, and the bridge was too narrow and not durable enough to survive. Within six years, a concrete bridge was built from Fowler Street to serve the Tamiami Trail; the Fremont Street bridge was destroyed by fire in the 1940s.



Figure 1.23: Wooden bridge from Fremont Street ⁷

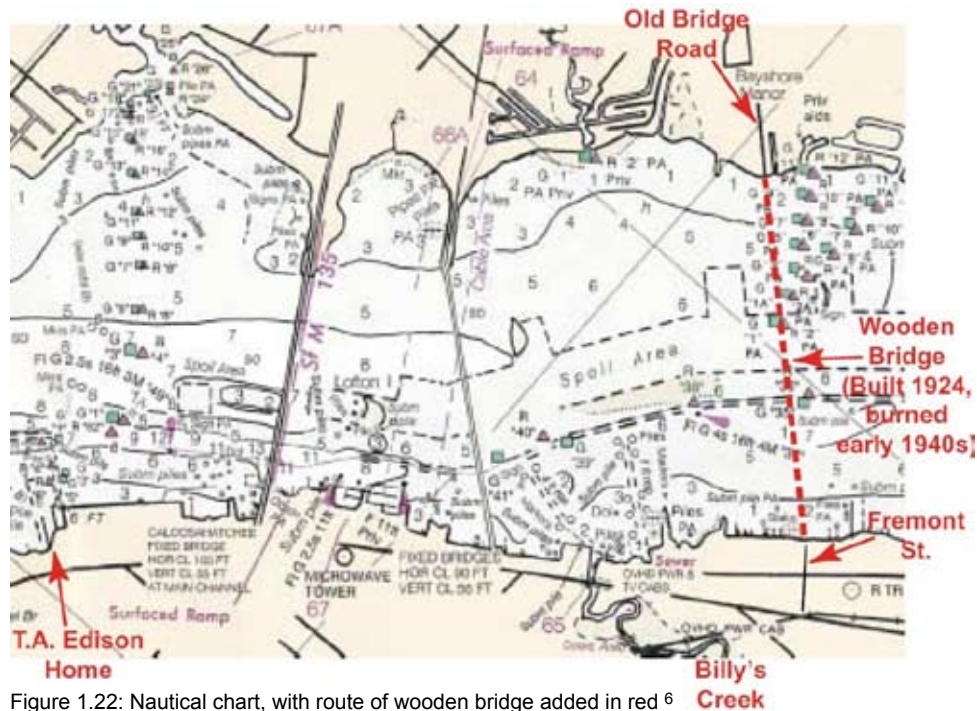

Figure 1.22: Nautical chart, with route of wooden bridge added in red ⁶



Figure 1.24: Postcard of "Tamiami Trail bridge" ⁸



Figure 1.25: "Caloosahatchee River highway bridge" in 1926 ⁹

A SECOND RAILROAD MAKES EAST FORT MYERS ITS HOME

To compete with the Atlantic Coast Line (ACL), its arch rival the Seaboard Air Line (SAL) built a second set of tracks to Fort Myers. These tracks were extended from Fort Ogden and crossed the Caloosahatchee on a separate bridge, which entered East Fort Myers where the Riverside Community Center is now located.

The first SAL freight train arrived in late 1926, terminating at new freight yards between Billy's Creek and Michigan Avenue. Passenger service began in 1927 from a new terminal on East Riverside Drive. SAL had great ambitions, also extending tracks from their freight yard east to LaBelle and west toward Punta Rassa.

This period marked the greatest extent of rail service to southwest Florida. SAL began reducing service during World War II and discontinued all service to Fort Myers in November 1952, immediately removing the remaining tracks. The bridge over Caloosahatchee also was removed; the passenger terminal later became Reilly Brothers, a prominent supplier of building materials. Only the ACL continued providing rail service to Fort Myers.*

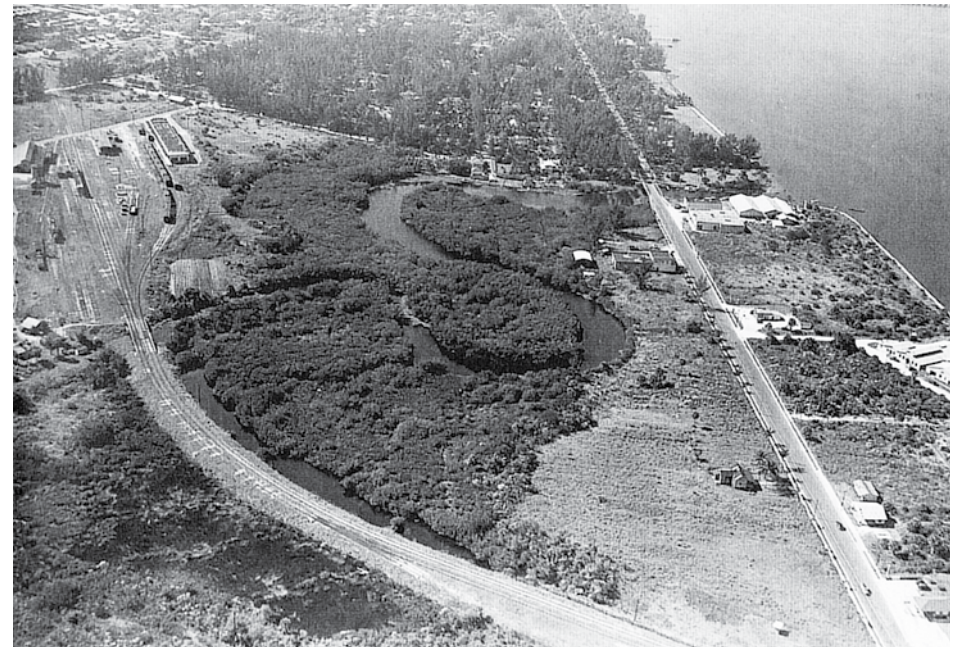

Figure 1.26: Billy's Creek crossed by new SAL tracks, with freight yards extending from the creek to Michigan Avenue ¹²



Figure 1.27: Governor John Martin at opening reception for new terminal ¹⁰



Figure 1.28: New SAL passenger terminal on East Riverside Drive ¹¹

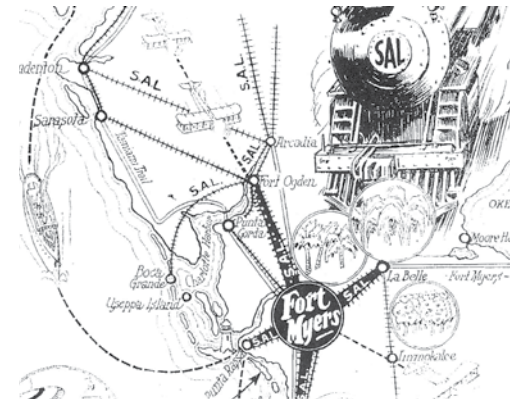

Figure 1.29: SAL advertisement; rival ACL tracks are barely noticeable ¹³



Figure 1.30: Fort Myers street map showing SAL and ACL tracks ¹⁴

* After a decade of discussions, these rail lines finally merged in 1967 to become the Seaboard Coast Line, and after additional mergers, CSX. In 1987 CSX began leasing its tracks south of Arcadia to Seminole Gulf Railway, a Fort Myers company, which continues to operate freight and various excursion services.

THE GOLDEN AGE OF EAST FORT MYERS

The early 1920s were optimistic times for East Fort Myers. Beautiful homes were being built in new subdivisions near the river and retail buildings were springing up along East First Street. The railroads attracted light industrial activities as well.

To add to the prosperity, the Tamiami Trail now crossed the river at Freemont Street, promising a steady stream of customers for local businesses. A new passenger terminal was built nearby on East Riverside Drive.

For a brief period it seemed that East Fort Myers could even surpass the original city of Fort Myers. As early as 1923 there were serious discussions about forming a separate city. East Fort Myers actually incorporated as a distinct city in early 1925 and elected a Mayor and City Council. But the high cost of providing city services quickly became apparent, and East Fort Myers voters agreed to be annexed into Fort Myers in December 1925.

Earlier that year Fort Myers had expanded to the south and west. In 1926 Fort Myers officials hired a New York City planner, Herbert S. Swan, to create "The Fort Myers Plan" for the new and much larger city. A major topic of analysis was whether the Freemont Street bridge would prove adequate or be replaced with a concrete bridge closer to downtown.

The Fort Myers Plan contained a "Comprehensive Plan of Development," a detailed map of the entire city that showed existing streets and rail lines as well as proposed civic and private improvements. A portion of that map is reproduced here, with the East Fort Myers study area outlined in red. The river crossings for the SAL and Tamiami Trail are shown as they existed at that time, but with a vastly improved road network leading to the bridge.

Note these other ambitious proposals from the 1926 Fort Myers Plan:

1. A wide Caloosahatchee Park to be built along the entire waterfront, with the river being filled to create this park.
2. "Second in importance to Caloosahatchee Park would be a parkway in East Fort Myers along Billy's Creek.... Creeks are always features of great interest in Florida. Their varied and dense tree growth overhanging the river always attracts attention.... These creeks and their banks should therefore be preserved for the benefit of the public and made the most of in the park design."

3. A broad diagonal parkway, "Central Boulevard," was proposed to run southwest from the site of today's Billy Bowlegs Park across the entire city to allow traffic to flow parallel to the river.
4. Palmetto Avenue and Van Buren Street were proposed to extend southward across the entire city. Palmetto (now Veronica S. Shoemaker Boulevard) is now reaching this goal, eighty years later.

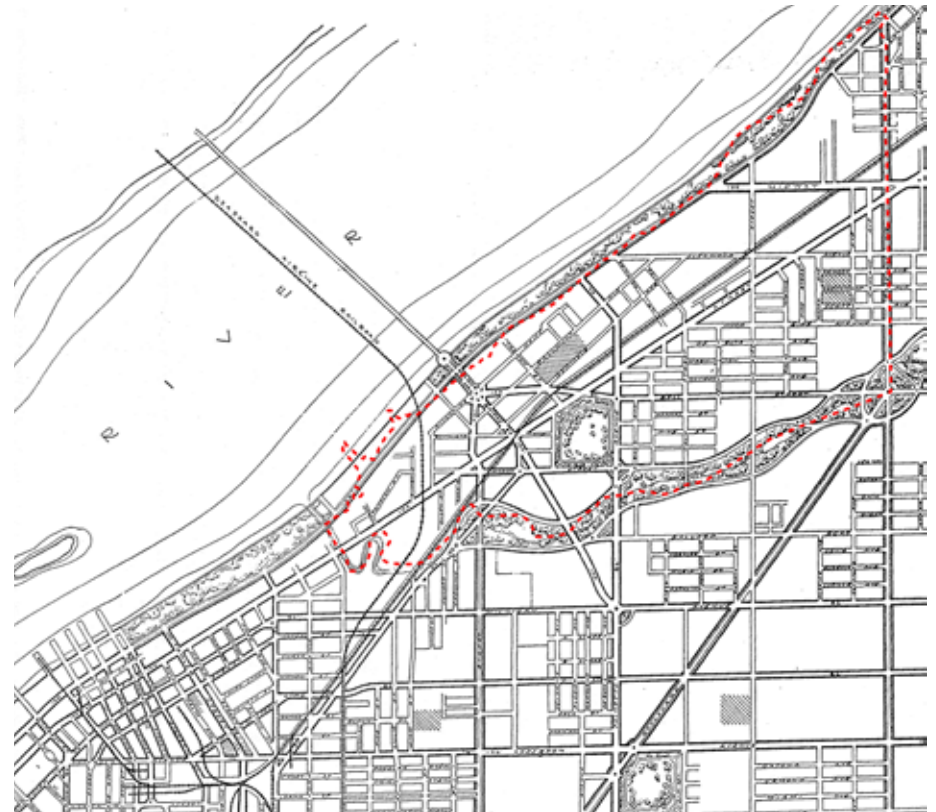

Figure 1.31: "Comprehensive Plan of Development," Fort Myers Planning Board, 1926. ¹⁵ The study area is outlined in red.

THE DREAM OF EAST FORT MYERS BEGINS TO DECLINE

Despite the many enduring achievements of the 1920s, it was also a time of foolhardy speculation, especially in Florida real estate. Unheard-of sums of money and building supplies flowed into Florida. Even sleepy Fort Myers got swept away, financing public improvements with bond issues that could never be repaid. Many of the best buildings and neighborhoods in Fort Myers were constructed during this period, but it was not to last.

A devastating hurricane in September 1926 demonstrated to all the risks of living in the sub-tropics, even in Fort Myers, far from the storm's direct path. The photos to the right were typical of local damage; the brand-new Starnes Building on East First Street at Superior housed a drug store, barber shop, furniture store, and A&P grocery. The building had a red-brick facade and the traditional Fort Myers hanging canopies to protect customers from the sun and rain. The new Citizens Bank was built just across Superior Street the same year, and the Family Theater and yet another grocery store were across East First Street, making this location the commercial heart of East Fort Myers.

The Florida real-estate boom of the 1920s was already beginning its inevitable crash when the 1926 hurricane caused prices to plunge further. Within three years the entire nation entered the Great Depression, during which little was built except for projects sponsored by government agencies. When the concrete Edison Bridge was completed across the river from Fowler Street in early 1931, the dream of East Fort Myers becoming an equal to downtown Fort Myers vanished forever. Unlike Tice to the east which always had a separate identity, East Fort Myers became known as the "East End" or simply part of the city of Fort Myers.

As East First Street was widened to become today's Palm Beach Boulevard, on-street parking was removed in front of the best commercial buildings, reducing their viability for most commercial purposes. The installation of median strips in 2007 further reduced the ability of customers to reach businesses and move around the neighborhoods.



Figure 1.32: Starnes Building after 1926 hurricane, looking northwest across the foot of Superior Street ¹⁶



Figure 1.33: Starnes Building after 1926 hurricane. ¹⁷



Figure 1.34: Starnes Building in 2007, after prior road widenings but during median installation ¹⁸

SCHOOLS & CHURCHES

The first Edgewood School was started in 1911 and opened in 1913, a wood-frame structure for 50 students in grades 1 through 8. This school was built between Edgewood and Seminole Avenues just east of Tarpon Street. A bungalow cottage was added around 1916 to provide extra classroom space.

The main school building burned down and was replaced on the same site in 1924 with a two-story brick school that according to the Fort Myers Press was equipped with “electric lights, running water, and nearly fireproof.” In addition to its regular classes, the school later served handicapped children and also became the first Alternative Learning Center for students with disciplinary problems.

The 1924 school burnt down and was replaced by a single-story building in the early 1990s that now houses the Edgewood Academy, which serves 700 students from surrounding neighborhoods and around the county.

A room in the original Edgewood School was used for Methodist church services beginning in 1913. This congregation opened its own church in 1919, originally called the East Fort Myers Methodist Church and later Edgewood United Methodist Church. The current sanctuary on Freemont Street was built in 1960.

In 1916, members of the First Baptist Church of Fort Myers formed a new Edgewood Baptist Church, which opened in 1920. This church became the Riverside Baptist Church, which later split and moved to two locations outside the community. The original facilities at 940 Tarpon Street are now used by Covenant Community Ministries.

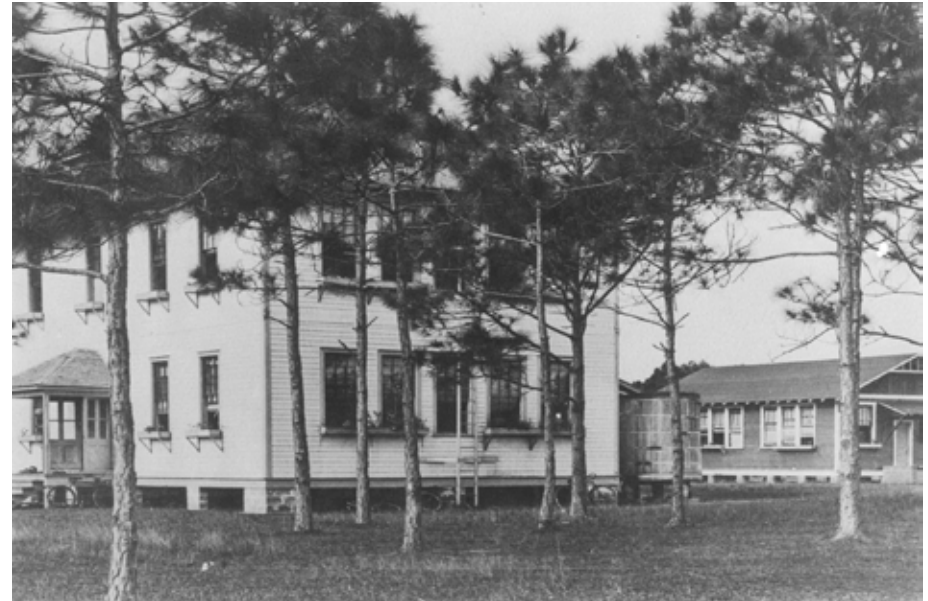

Figure 1.35: Photo of first Edgewood School and cottage ¹⁹



Figure 1.36: Later photo of second Edgewood School ²⁰

COMMUNITY AND REGIONAL PARKS

In 1906, the site of the present-day Terry Park was donated for a new “Fort Myers Yacht and Country Club.” A clubhouse was built two years later, but the country club went out of business in 1914.

In 1919 the country club site was donated to Lee County and the first Lee County Fair was held here. Marshall Terry donated additional land in 1919 to expand the site. Major league baseball arrived in 1925 when the Philadelphia Athletics began spring training at this location.

Terry Park was home to the Lee County Fair (later the Southwest Florida Fair) until 1978. In addition, Terry Park has been home to motorcycle and horse races, professional wrestling, high school and college sporting events, as well as spring training for major league baseball (until 1989).

Just to the south of Terry Park is Shady Oaks Park. This site between Marion Street and Billy’s Creek was acquired by the city of Fort Myers in 1969. Shady Oaks has provided one of the few public access points to Billy’s Creek.

Billy Bowlegs Park was established in 1950 on Marsh Avenue just north of Billy’s Creek. The Riverside Community Center and riverfront park was opened in 2000 where the SAL railroad bridge had landed on the banks of the Caloosahatchee.



Figure 1.38: Fort Myers Yacht and Country Club opened in 1908 and later became Terry Park. ²²

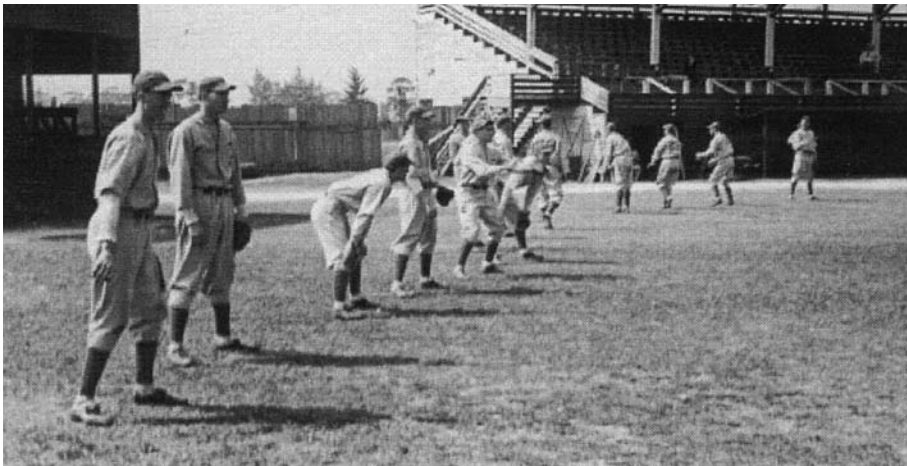

Figure 1.37: The Philadelphia Athletics practiced at the second Terry Park stadium. ²¹



Figure 1.39: Terry Park in the late 1930s, looking over Marion Street toward the river. East First Street (now Palm Beach Boulevard) runs along the top of this photograph; Palmetto Avenue (now Veronica S. Shoemaker Boulevard) is just off the right edge. Produce and livestock exhibits for the fair were located in the circular buildings. ²³

1930s IN EAST FORT MYERS

The entire nation struggled during the Great Depression. Construction nearly halted, tourism dropped, and demand for oranges and grapefruit dropped, harming even small farms in southwest Florida.

Because construction had nearly halted after the 1926 hurricane and government finances were already in great turmoil, the initial effects of the depression were less noticeable in Fort Myers than other places. Northern refugees drifted into town but were considered beggars or a further threat to already high unemployment levels.

Fort Myers officials started their own employment bureau to find jobs for “worthy” local workers; black workers were sent to any available jobs in the sugar mills at Clewiston. Service and civic clubs joined the effort but it was doomed by the lack of jobs and the overall grim financial situation.

Federal job-creation programs soon became the employer of choice for many workers. In addition, federal grants became available for public works projects, which were eagerly sought and obtained by local officials for river dredging and a new yacht basin.

Although private development was at a standstill, a new form of tourism emerged. Visitors towed house trailers and became known as “tin-can tourists.” The Palm’n Pine trailer camp in East Fort Myers even provided city water and sewer hookups; the camp remains today as a mobile home park.



Figure 1.40: Lee County rail lines in 1932 ²⁴



Figure 1.41: Railroad trestles were built to span creeks and rivers. ²⁵

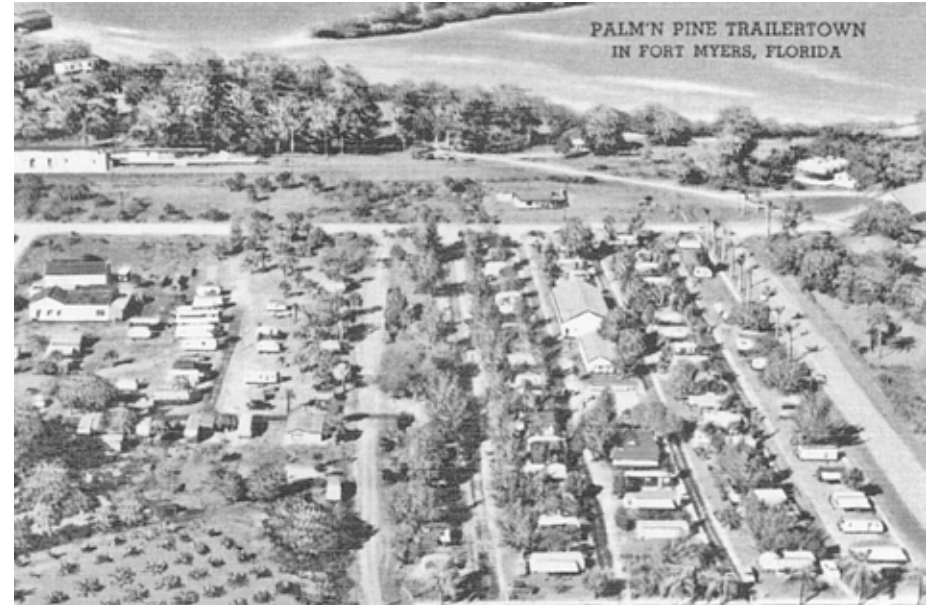

Figure 1.42: 1938 postcard of Palm'n Pine Trailertown, still in existence in East Fort Myers ²⁶

1940s AND LATER

This aerial photograph shows East Fort Myers in 1944. The study area is outlined in white. Note that agriculture still dominates riverfront land east of Veronica S. Shoemaker Boulevard (then known as Palmetto Avenue). Residential neighborhoods south of Palm Beach Boulevard east of Palmetto were well-established much earlier. As of 1944, Marsh Avenue has not yet been extended south of Glenwood Avenue. The SAL tracks and rail bridge are clearly visible in the lower left corner.

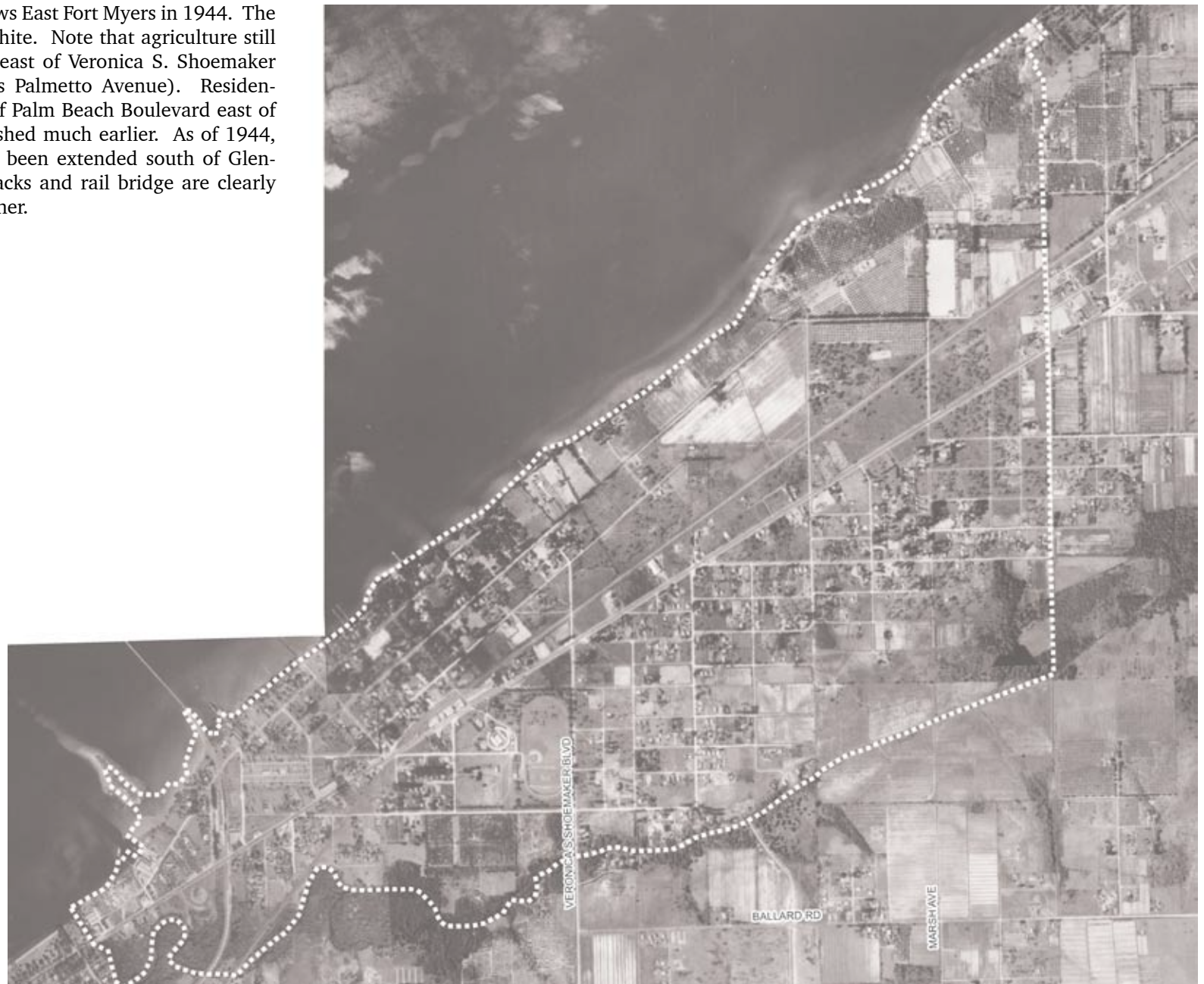
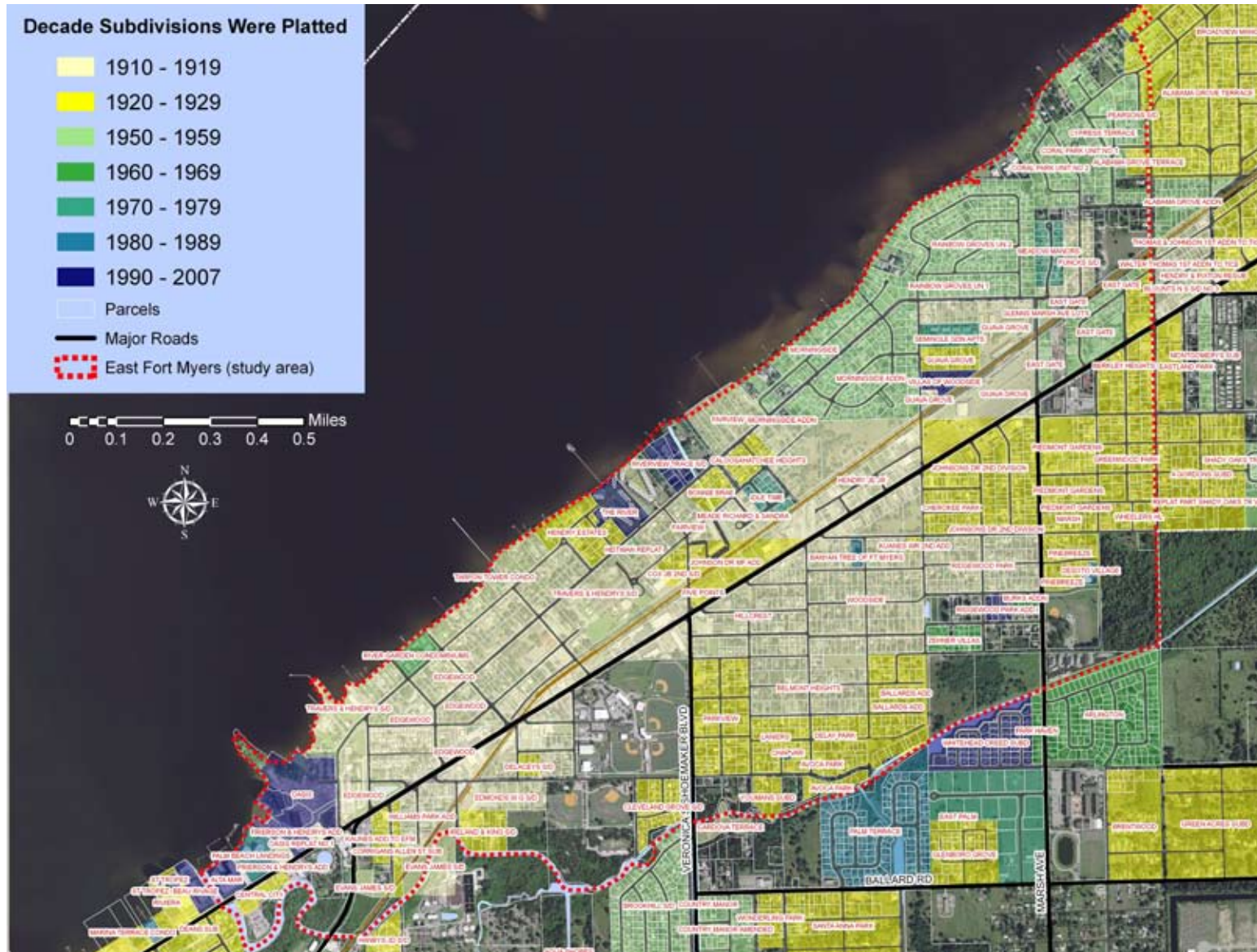

Figure 1.43: East Fort Myers in 1944 ²⁷

ERAS OF SUBDIVIDING AND BUILDING IN EAST FORT MYERS

Most land in East Fort Myers was subdivided prior to the Great Depression. The map below indicates the decade during which each major subdivision was platted. None were platted during the 1930s or 1940s. The map on the following page shows the earliest year that structures that remain today were first

identified on Lee County's tax records, using the same colors as the previous map. These records are occasionally inaccurate, and usually do not reflect the age of condominium buildings; but this map provides a quick survey of the era when each neighborhood was occupied.



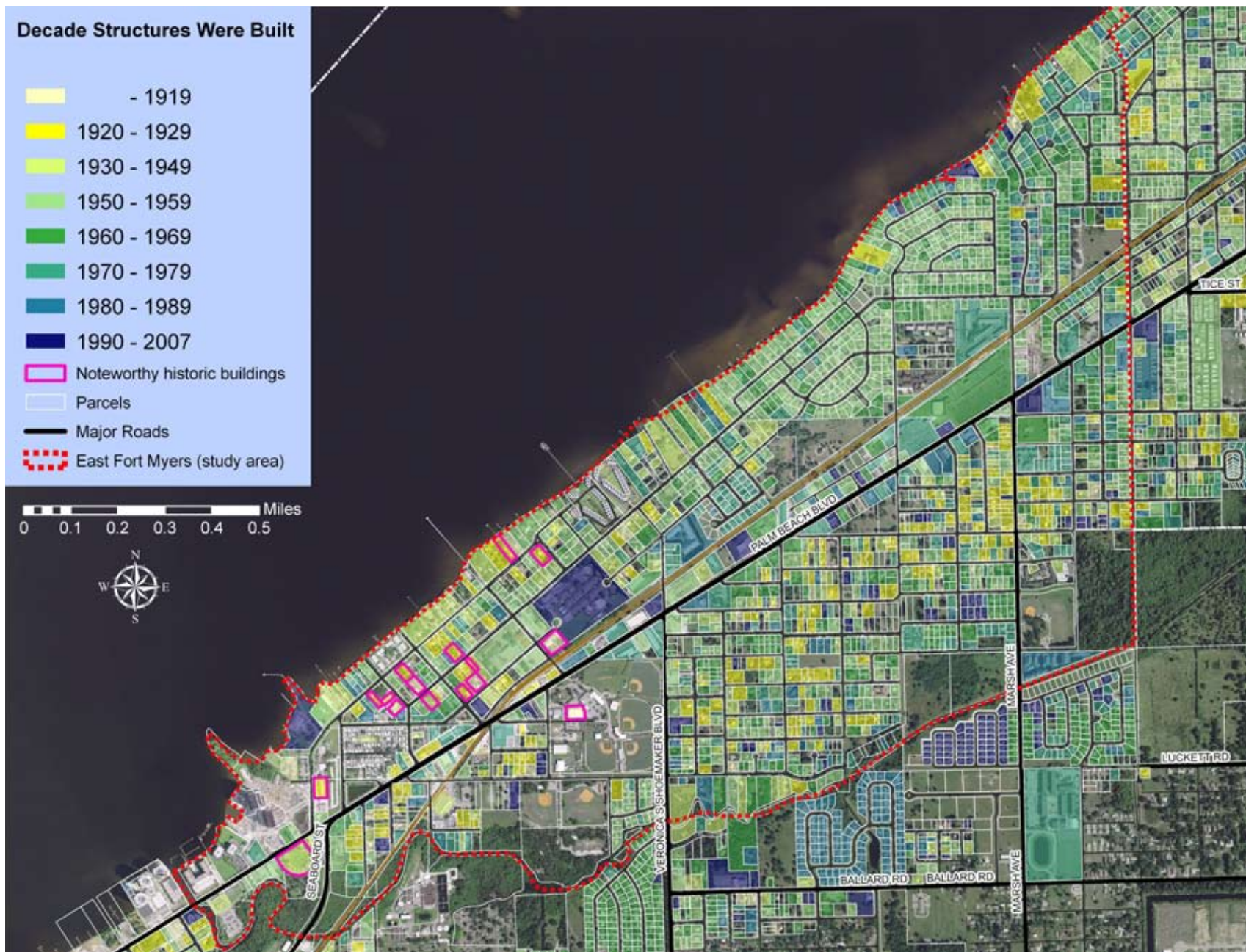

Figure 1.45

LANDMARK BUSINESSES

Several local businesses became landmarks in East Fort Myers. The Rock Lake story began in 1946 when a circular lake along Palm Beach Boulevard was fed by an artesian well that began keeping the lake level high year around. Coral rock cottages were built one at a time around the lake; the picturesque cottages later became the Rock Lake Motel. The cottages have recently been renovated and operate as part of the Rock Lake Resort.

The beautiful Seaboard Air Lines passenger terminal on East Riverside Drive is better known to most people as Reilly Brothers, “the house of house parts.” This supplier of new and used building materials expanded around the original terminal, operating in the area from 1947 until recent years. The terminal is expected to be retained when the remainder of the site is redeveloped.

Daniels Brothers occupied the east side of the mouth of Billy’s Creek. This family firm was well known for designing and building durable wooden boats. This site is now part of the Alta Mar condominium tower.



Figure 1.47: Reilly Brothers, "the house of house parts" ²⁹



Figure 1.46: Postcard of Rock Lake Motel ²⁸



Figure 1.48: Postcard of Daniels Brothers Boatbuilders ³⁰

PREVIOUS STUDIES

In addition to photographing the study area and learning its history, the team analyzed past studies of the area, recent development proposals, traffic accident data, and other relevant background information. The reports and plans helped the team to better understand recent efforts to revitalize the area and community involvement in creating such plans. Using geographic data provided by city staff, the team created a series of analysis diagrams to better understand the dynamics of East Fort Myers.

Community planning for this area began with the “Palm Beach Boulevard Community Plan” in 2002, sponsored jointly by a civic group, the East Lee County Council, and a business group, the Palm Beach Boulevard Corporation. This plan included land in the unincorporated county east as far as I-75. Upon completion the plan was accepted by both the City Council and County Commissioners; the Lee County Comprehensive Plan has a separate section devoted to policies that resulted from that plan.

In early 2006 Fort Myers began a more intensive study of the city portion of East Fort Myers. This would lead to the May 2007 version of the “East Fort Myers Revitalization and Redevelopment Plan.” Construction of highrise towers was extending east from downtown at a rapid pace and city leaders decided a more thorough examination was warranted as to whether this same development pattern was suitable for East Fort Myers. Three sub-areas were examined:

1. The central corridor formed by Palm Beach Boulevard and the railroad
2. The residential neighborhoods north of the corridor
3. The residential neighborhoods south of the corridor

Due to strong development pressure, most attention was paid to the residential neighborhoods north of Palm Beach Boulevard, particularly the sub-area from Billy’s Creek east to Tarpon Street. Ultimately some of the strongest recommendations of that study, which would have limited building heights to three and five stories in that sub-area, proved too controversial and were removed from the plan when it was adopted in May 2007. The City Council decided at that time to reconsider building height and density questions in the current study, while also putting a greater emphasis on the Palm Beach Boulevard commercial corridor and on the residential neighborhoods south to Billy’s Creek.

Through the adoption of that plan in May 2007, the city was able to formally initiate a Community Redevelopment Area for East Fort Myers. The current study is intended to update and replace the May 2007 plan as the official redevelopment plan for East Fort Myers, as most of the previous findings and proposals have proven valid and have been incorporated into this document.

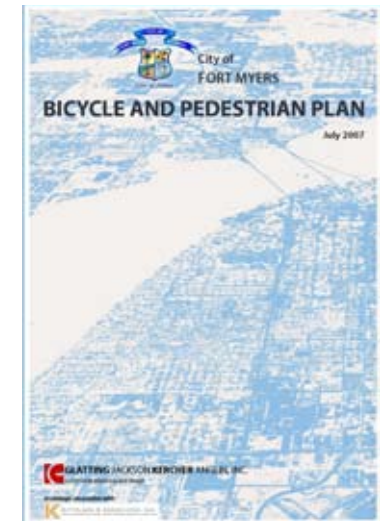
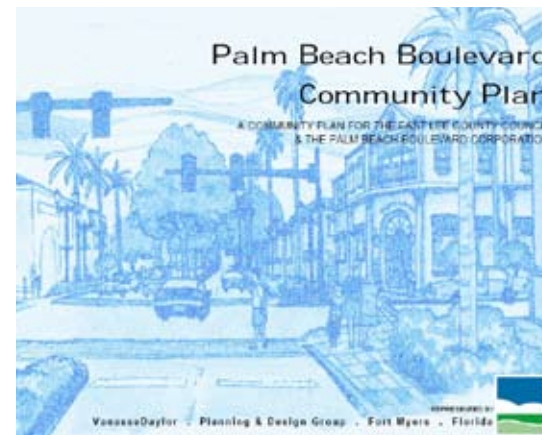
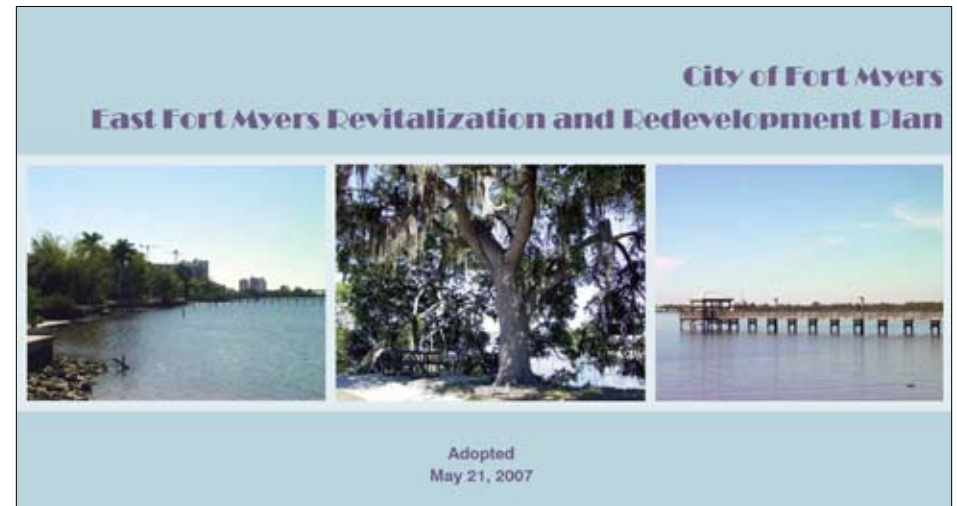

Figure 1.49: Previous studies

ANALYSIS DIAGRAMS

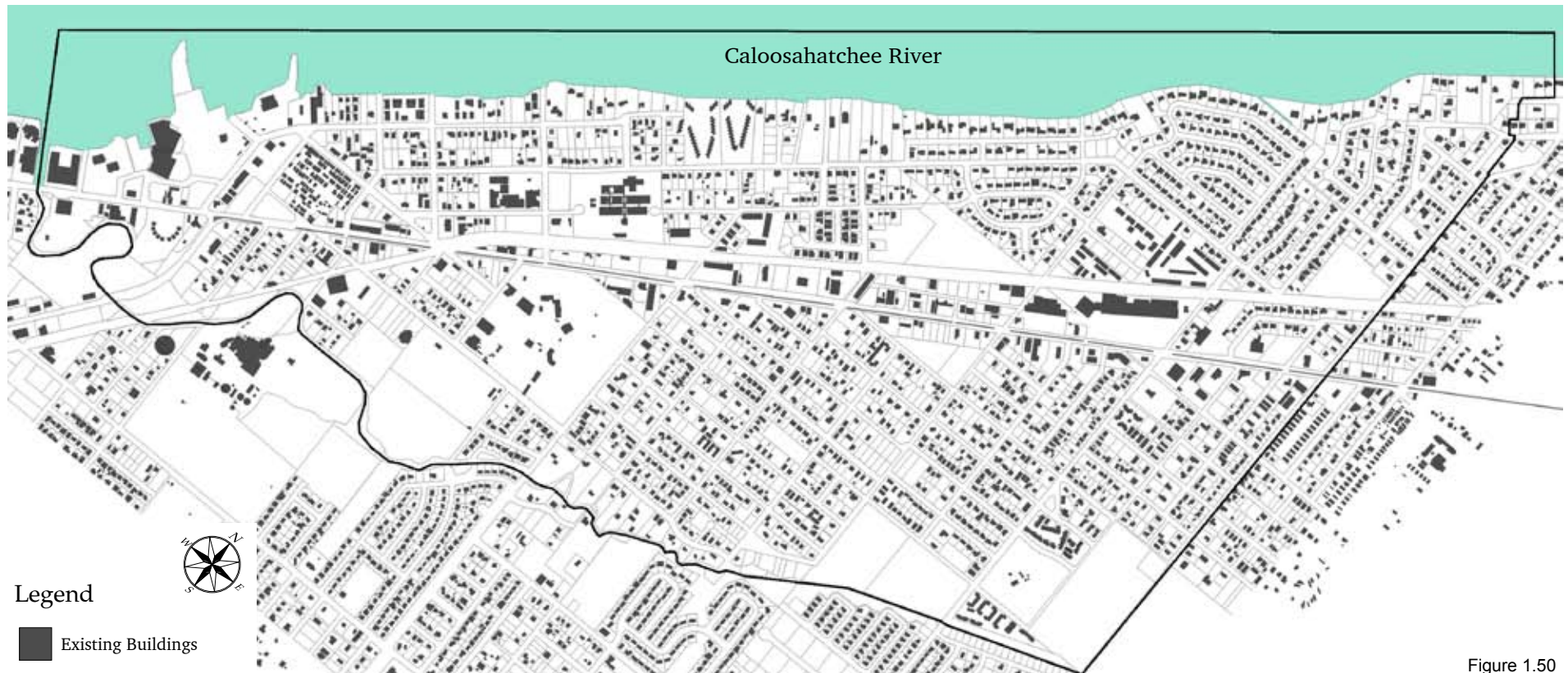

Figure 1.50

EXISTING BUILDING CONDITIONS/ BUILDING COVERAGE

One way to assess the physical structure of a community is to examine a figure-ground map of building coverage, as presented above for East Fort Myers. Buildings are shown in solid black, while unbuilt space is left white. The only other information provided are rights-of-way and lot lines. Neighborhoods are made up of buildings of many sizes and shapes, public spaces such as streets and parks, and (sometimes) vacant land awaiting use. A building coverage diagram highlights just the buildings, which allows one to understand how complete the neighborhood fabric is. Do the buildings physically define a coherent “public realm” of streets and open spaces, or are the buildings placed randomly on their lots? Are there easy paths for movement within and outside the neighborhood, or is access restricted?

A building coverage diagram can quickly identify vacant parcels that may be appropriate for infill development or available for green space such as parks. From the scale of surrounding buildings and their relationship to their lots, infill can be visualized that continues the pattern of its neighbors.

Without lot lines and rights-of-way on this diagram, it would be difficult to discern the street pattern of some parts of East Fort Myers. This is especially true along Palm Beach Boulevard and on riverfront land near Billy’s Creek. Healthy neighborhoods usually exhibit an intact block structure. A building coverage diagram also reveals which structures are not contributing to a healthy community. It is easy to identify the buildings that have caused ruptures in both neighborhood scale and street connectivity. Redevelopment opportunities can be identified by finding sites whose buildings do not contribute to a pattern of legible blocks and open spaces.

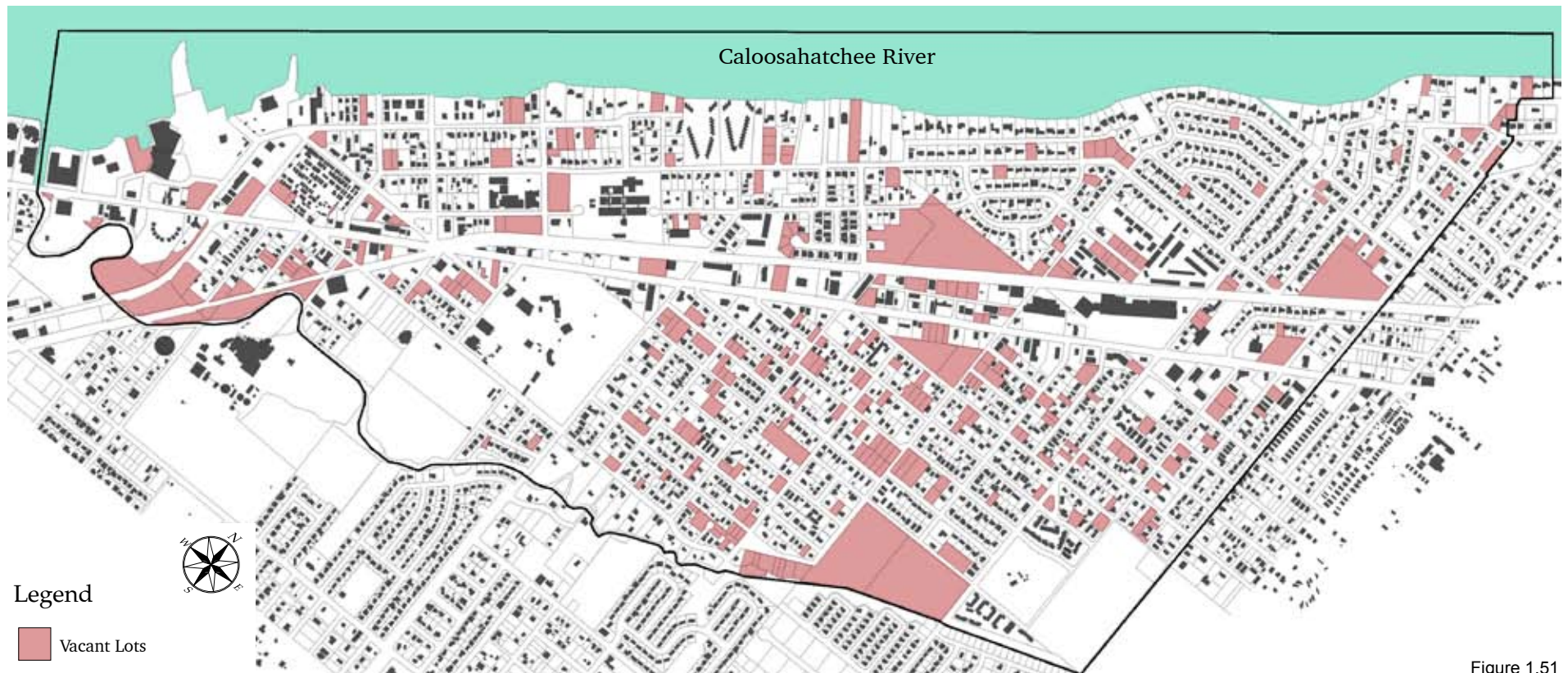

Figure 1.51

VACANT VS. OCCUPIED LOTS

This diagram of vacant and occupied lots shows the “missing teeth” in the physical structure of East Fort Myers. Vacant properties have been added in pink to the building coverage map from the previous page. Parks have not been shaded because they will remain as permanent open space; only those properties that could be developed are shaded in pink.

The pattern of vacant lots also highlights neighborhoods that have never been completed or that have suffered the loss of housing stock, often indicating instability. Areas with a long stretch of street without inhabited structures are likely to have problems due to a lack of natural surveillance by neighbors.

This diagram indicates parcels that might receive infill development or become the sites of future parks. Vacant lots, especially where they cross a block or align with other vacant lots, can also provide opportunities for opening new streets where the existing street network is incomplete.

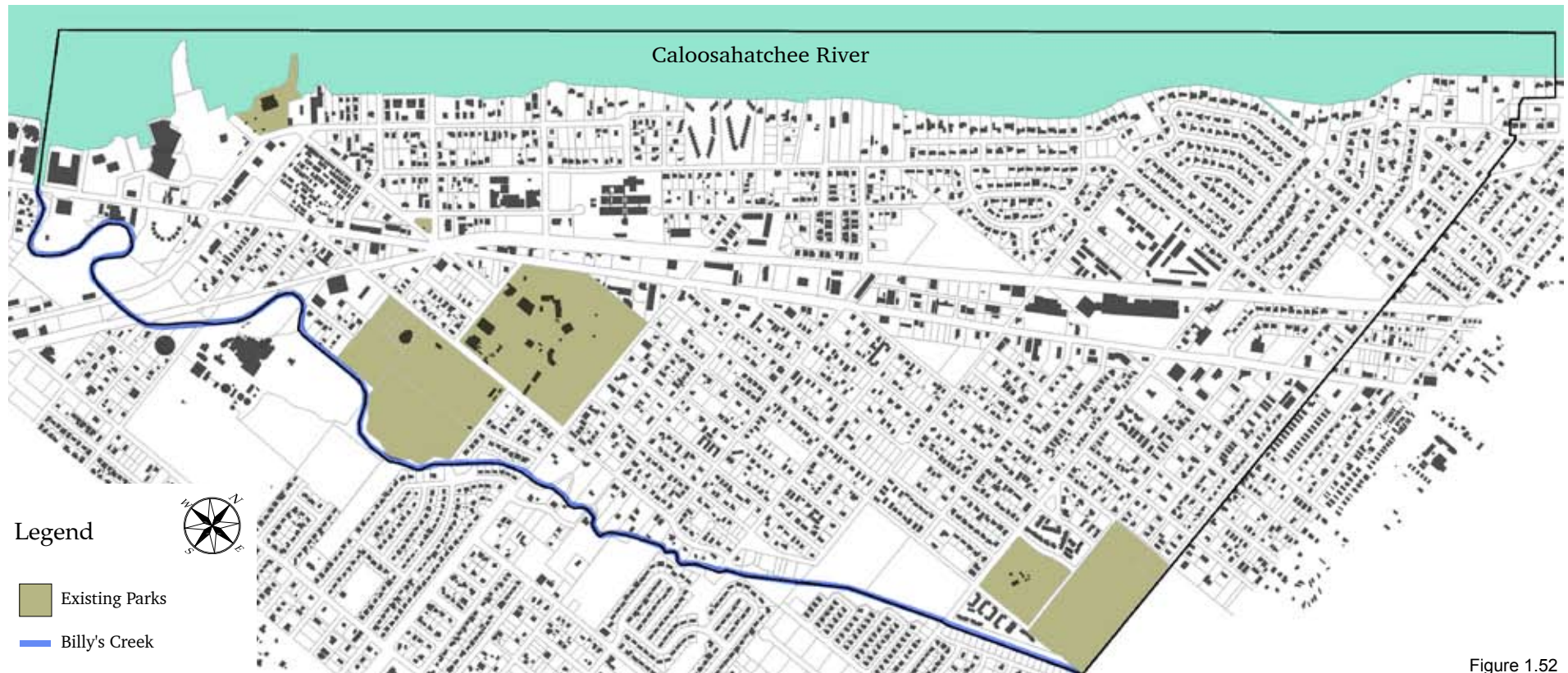

Figure 1.52

EXISTING GREENS AND OPEN SPACES

The inventory of existing greens and open spaces shows that East Fort Myers has the beginnings of an “emerald necklace.”

Large regional and community parks are located south of Palm Beach Boulevard. The western portion of East Fort Myers has two very large parks: Shady Oaks Park and Terry Park. The eastern portion has Billy Bowlegs Park; between them there are no parks. Other than the excellent Riverside Park and the Tarpon Street pier, there is almost no usable public open space north of Palm Beach Boulevard.

Although East Fort Myers as a whole has an abundance of green space, plus frontage on the Caloosahatchee and Billy’s Creek, many neighborhoods lack even the smallest neighborhood park or playground where residents can enjoy the outdoors or meet with family and friends.

Parks of all sizes can be useful to the community and can serve many different needs. Both passive and active spaces are essential; some should be wild while others should be manicured and programmed. Some may incorporate paved plazas for gathering spaces or ball courts while others would be completely pervious and landscaped. Some may serve a pragmatic function such as drainage while others may include settings for art or performances. Some may be “drive-to” destinations, but others should be small in size and sited as “walk-to” destinations for under-served neighborhoods.

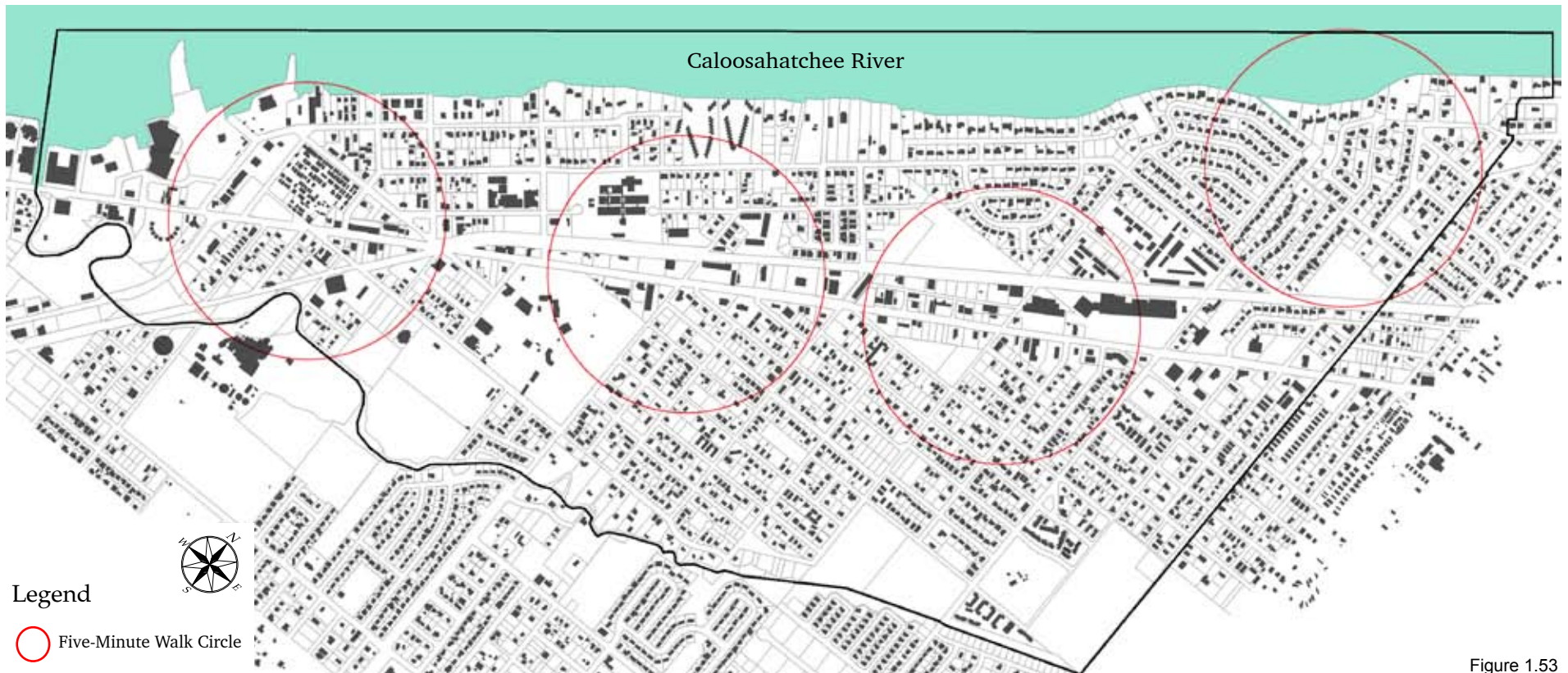

Figure 1.53

THE FIVE-MINUTE WALK

If streets are walkable and neighborhoods are sufficiently mixed-use, most people feel comfortable walking a distance of approximately ¼ mile (1320 feet) or 5 minutes before opting to drive or ride a bike. This dimension is a constant which can be observed in settlements around the world built during the last several millennia. It also relates to the manner in which people define the edges of their own neighborhoods. Often, a neighborhood has a larger commercial street or natural barrier at its edge. Of course, neighborhoods are not necessarily circular in design, nor is that desirable. The ¼-mile radius is simply a benchmark for creating a neighborhood unit that is manageable in size and is inherently walkable. Neighborhoods of many shapes and sizes can satisfy the ¼-mile radius test.

Although four walking circles are illustrated here, there may be many more than just these, centered upon different nodes of activity. One can use the walking circle to determine which amenities, services, or retail may be missing within a neighborhood. This can inform policy makers how to promote development that captures car trips rather than development that generates car trips. It also may inform policy makers where development should occur to encourage walking. For instance, schools should be located near a concentration of residential units so that students may walk or bike to school. Likewise, new residential units suitable for households with children should be encouraged within ¼ mile of schools.

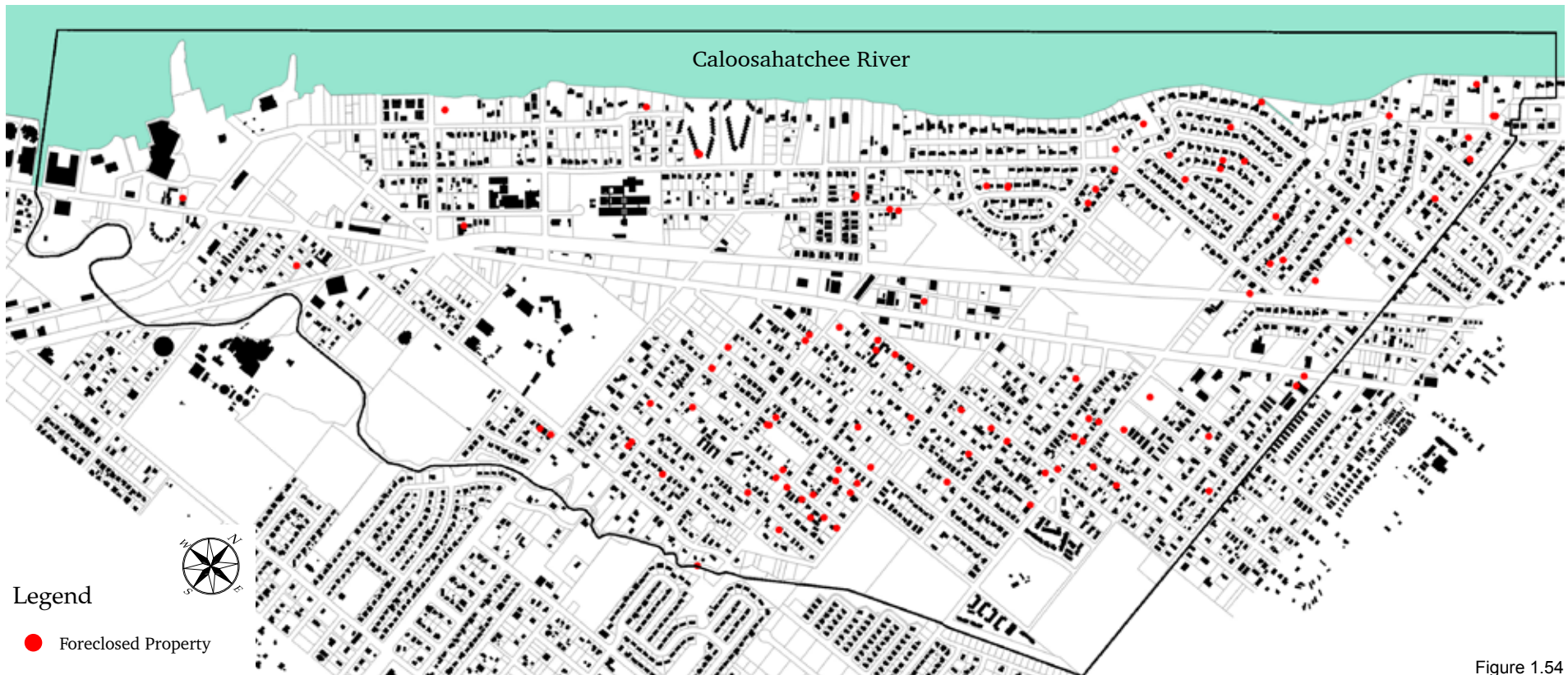

Figure 1.54

FORECLOSURES

Lee County is one of the epicenters of the nation's economic crisis, triggered by the housing market collapse when housing prices began to drop. Although Lehigh Acres receives most of the local attention, East Fort Myers has been hit hard as well.

This diagram shows many foreclosures concentrated south of Palm Beach Boulevard between Veronica S. Shoemaker Boulevard and Marsh Avenue. There is a smaller cluster to the north of Palm Beach Boulevard near its intersection with Marsh Avenue. There are fewer foreclosures on the blocks that touch the Caloosahatchee River, especially in the western portion of the study area closer to downtown Fort Myers.

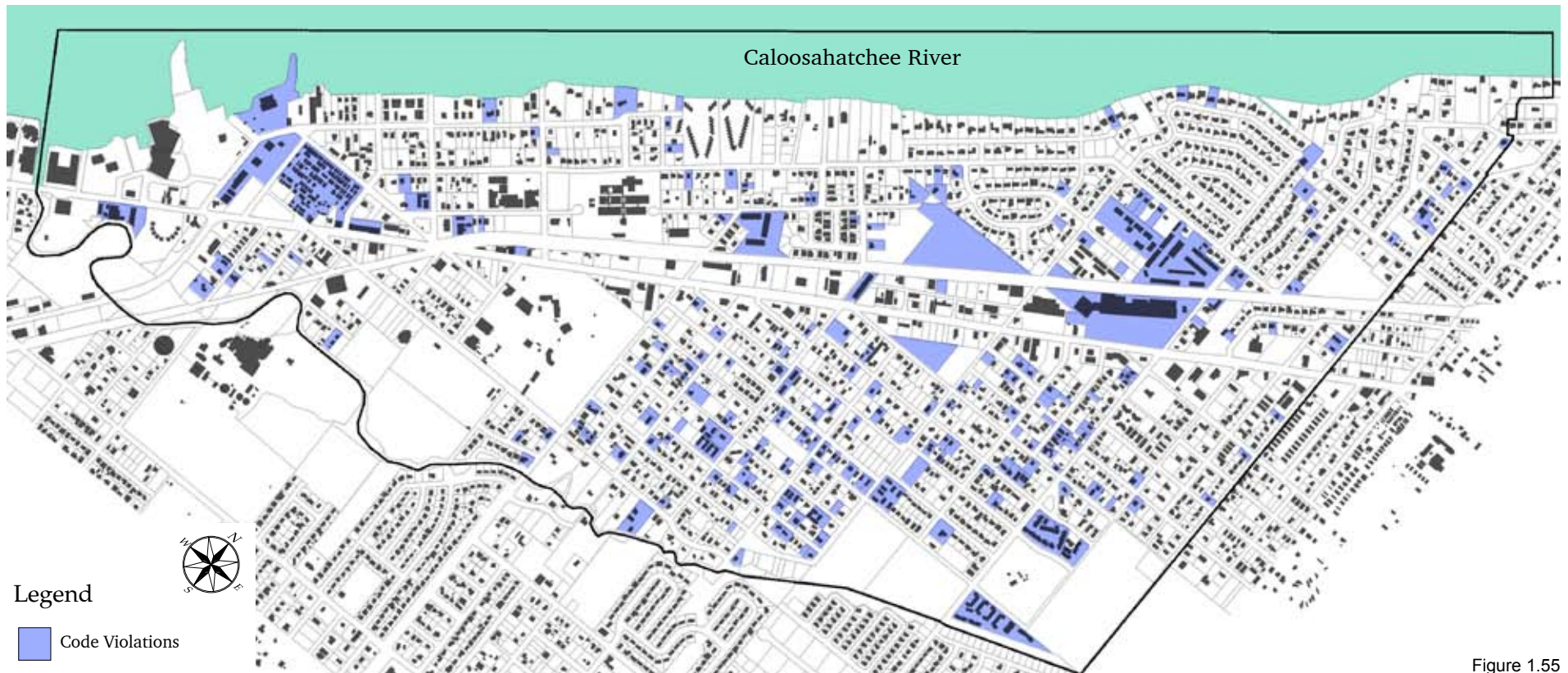

Figure 1.55

CODE VIOLATIONS

Code violations are triggered by owners neglecting their property. If the violations are corrected promptly, the system is working as designed and neighborhood problems are remedied in an unobtrusive way. If code violations are not corrected promptly, enforcement of the code violations through liens and fines and can trigger a continuing escalation of neglect that sometimes leads to abandonment of buildings and ultimately demolition. When a property is being foreclosed, active management often ceases. In this situation, code violations are often ignored completely.

Some structures were so poorly designed, built, or maintained that they are no longer candidates for rehabilitation. With the high vacancy rates, the trend toward demolition rather than rehabilitation may continue. Abandoned structures can pose environmental and safety hazards in addition to blighting surrounding properties. This blight often pushes potential homeowners and real estate investors away from the area, further depressing real estate values.

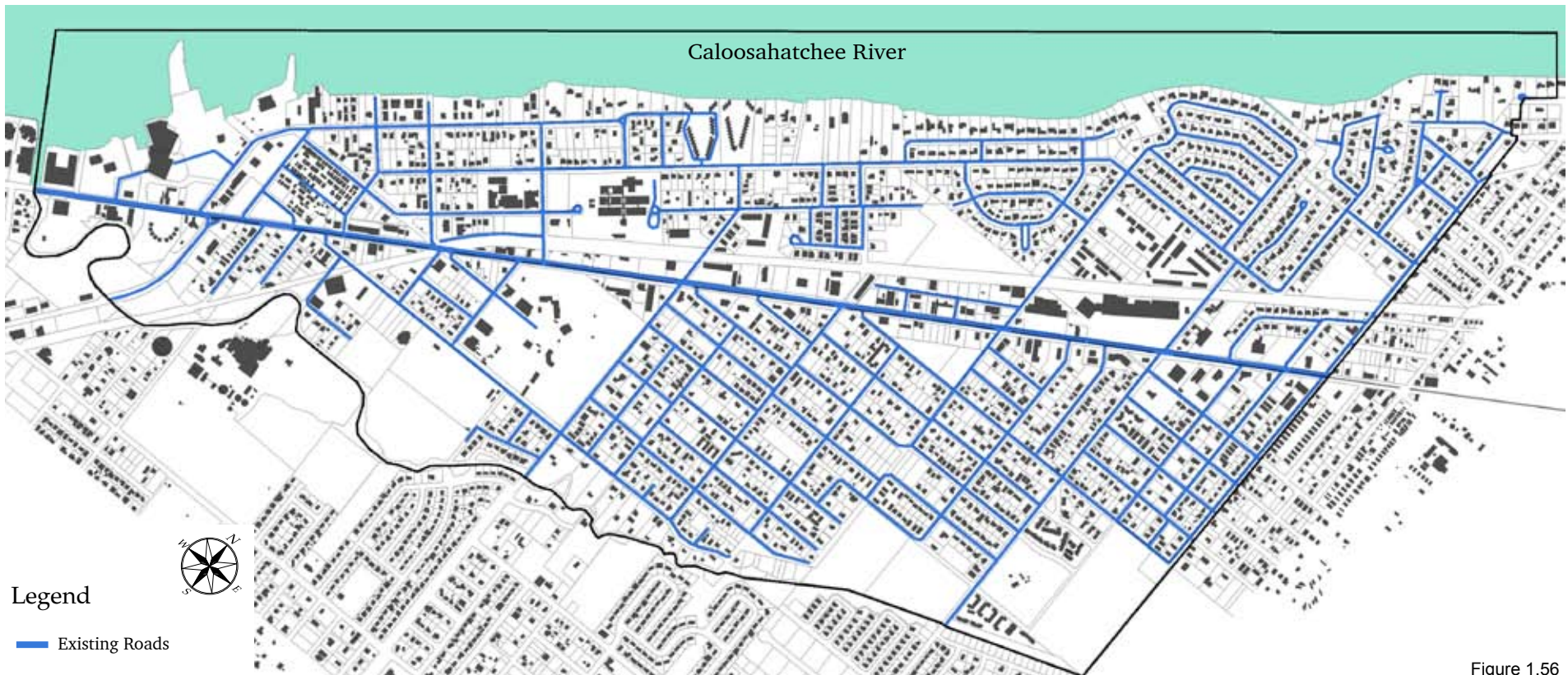

Figure 1.56

EXISTING ROADS

The existing roads diagram shows that most of East Fort Myers has an urban pattern of interconnected streets rather than a suburban pattern of collectors and culs-de-sac.

Even though the interconnected web is intact in most parts of the study area, there are areas where it has been compromised. Dead-end streets plague many neighborhoods. Some of them need not remain dead ends because there are rights-of-way that would allow them to be connected to the rest of the network.

Some streets have been vacated in order to create super-blocks. Removing through streets and allowing dead ends causes many different problems. For each dead-end street without through traffic, there are other streets that received the ex-

tra traffic. Emergency response time is increased due to a compromised street network. Pedestrians are frustrated by excessively long blocks or dead ends that lengthen their trips even when the destination may be close by. Lastly, a compromised street network has been shown to cause stagnation and natural surveillance problems, especially when these are combined with insensitive building types and overgrown vegetation.

There are, however, places where the occasional interruption of the street network is a healthy aspect to the layout of East Fort Myers. In the case of schools, large parks, and natural features such as Billy's Creek, pedestrian or wildlife precincts have been created (or could be created) because roads were prevented from crossing. Such exceptions to the interconnected street network should have fine-grained street networks at their borders.

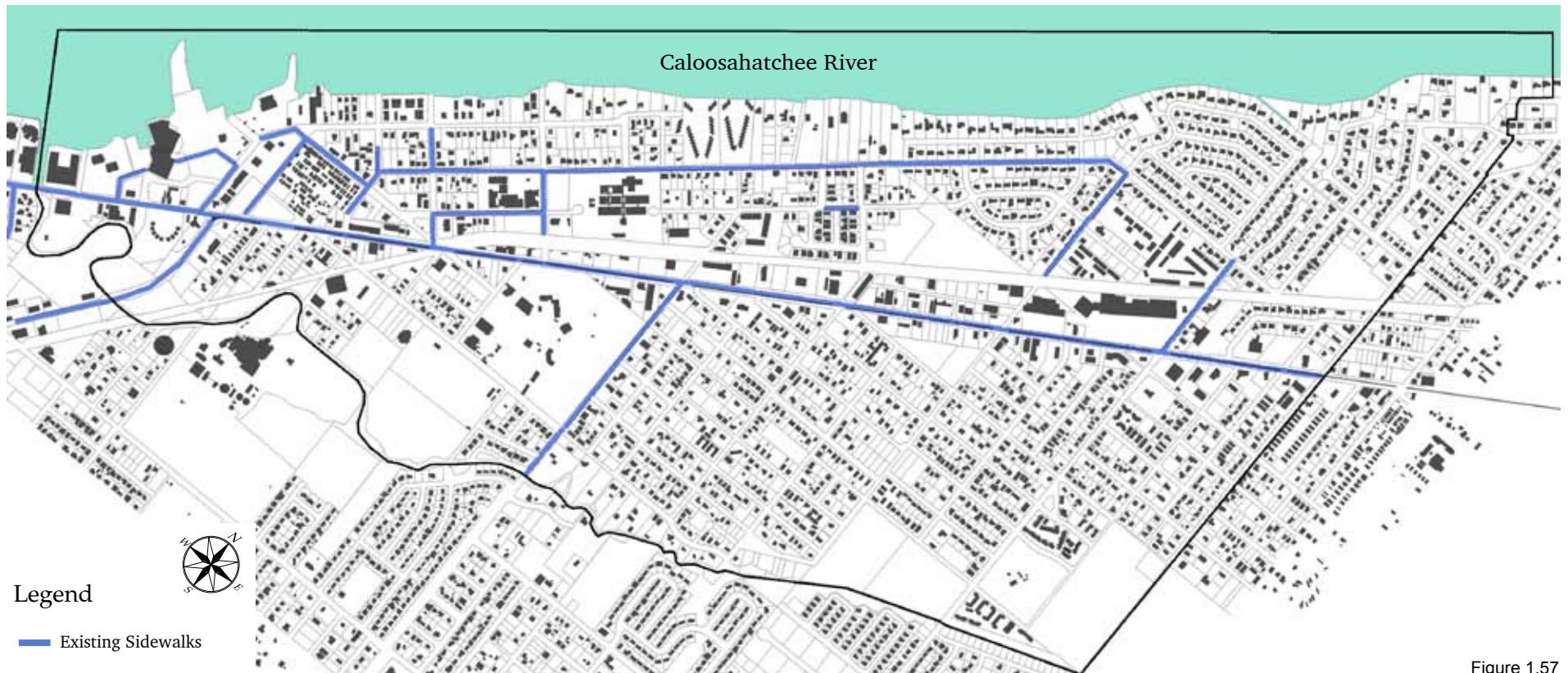

Figure 1.57

EXISTING SIDEWALKS

The existing sidewalks diagram shows that only a small minority of the streets have sidewalks in East Fort Myers. The majority of streets have no sidewalks at all or sidewalks only on one side of the street. This is inconvenient and unsafe for pedestrians and wheelchair users, who are forced onto the road to reach their destinations when sidewalks are missing.

On streets where traffic is light and cars travel slowly, some pedestrians will feel safe walking in the road. Yet in most cases, this lack of sidewalks causes pedestrians to feel less dignified and less comfortable than motorists.

In some cases pedestrians have created informal footpaths or ruts in the ground by constantly using a path along the side of the road; these ruts are indicators of high pedestrian demand and should be formalized as sidewalks. In some neighborhoods, drainage swales occupy the entire space between the roadbed and the property line, making sidewalks more expensive to install because the swale must be replaced with drainage pipes.

Many of the existing sidewalks run parallel to Palm Beach Boulevard. In order to convey pedestrians from the neighborhoods to the commercial centers along Palm Beach Boulevard, an important priority is to add sidewalks on streets that run towards Palm Beach Boulevard.

ILLUSTRATION CREDITS

1. Courtesy of the Southwest Florida Historical Society.
2. *Fort Myers Press*, February 11, 1904, reprinted in "Railroads of Southwest Florida" by Gregg M. Turner, Arcadia Publishing, 1999.
3. Navigation Chart for San Carlos Bay and Caloosa River, 1898 nautical chart 473, available from Office of Coast Survey's Historical Map & Chart Collection, accessed from www.nauticalcharts.noaa.gov/csdl/ctp/abstract.htm, with East Fort Myers outline added in red.
4. Florida Memory photographic collection N090891, State Archives of Florida, accessed from www.floridamemory.com/PhotographicCollection/.
5. "Sanborn® Fire Insurance Company Maps of Florida" collection, Smathers Libraries' Map & Imagery Library, University of Florida, Gainesville, accessed from www.uflib.ufl.edu/ufdc/?c=sanborn.
6. Nautical chart 11427 (1998), with additions provided by the authors of "A Historical Geography of Southwest Florida Waterways, Volume Two (Placida Harbor to Marco Island)" by Gustavo A. Antonini, David A. Fann, and Paul Roat, West Coast Inland Navigation District, 2002.
7. Courtesy of Bobby J. Rambo, reprinted in "Lee County: A Pictorial History," by Prudy Taylor Board and Patricia Pope Bartlett, Dunning Company, Roanoke Virginia, 1985.
8. Florida Memory photographic collection PC1209, State Archives of Florida, accessed from www.floridamemory.com/PhotographicCollection/.
9. From "The Fort Myers Plan," prepared for the Fort Myers Planning Board by Herbert S. Swan, City Planner, New York, 1926.
10. From "Railroads of Southwest Florida" by Gregg M. Turner, Arcadia Publishing, 1999.
11. Railroad Museum of South Florida collection, reprinted in "Railroads of Southwest Florida" by Gregg M. Turner, Arcadia Publishing, 1999.
12. Harmon Photo & Video, reprinted in "Railroads of Southwest Florida" by Gregg M. Turner, Arcadia Publishing, 1999.
13. Advertisement from Seaboard Air Line, reprinted in "Railroads of Southwest Florida" by Gregg M. Turner, Arcadia Publishing, 1999.
14. From "Fort Myers in Vintage Postcards" by Gregg Turner, Arcadia Publishing, 2005.
15. From "The Fort Myers Plan," prepared for the Fort Myers Planning Board by Herbert S. Swan, City Planner, New York, 1926, with East Fort Myers outline added in red.
16. Courtesy of the Southwest Florida Historical Society.
17. Courtesy of the Southwest Florida Historical Society.
18. William M. Spikowski, 2007 photograph.
19. Courtesy of the Southwest Florida Historical Museum.
20. From "The Story of Fort Myers", by Karl H. Grismer, 1949 edition republished for the Southwest Florida Historical Society by Island Press Publishers, 1982.
21. From "Terry Park Centennial Anniversary Commemorative Program, 1906-2006," Lee County Board of Commissioners.
22. From "Fort Myers in Vintage Postcards" by Gregg Turner, Arcadia Publishing, 2005.
23. Courtesy of *Sporting News*.
24. Courtesy of the Special Collections Department, University of South Florida; digitization provided by the USF Libraries Digitization Center; accessed from www.fcit.usf.edu/florida/maps/countgal/geol32/36geol32.htm.
25. Florida Memory photographic collection N029354, State Archives of Florida, accessed from www.floridamemory.com/PhotographicCollection/.
26. From "Fort Myers in Vintage Postcards" by Gregg Turner, Arcadia Publishing, 2005.
27. Images are from Aerial Photography Florida, a collection of PALMM, Publication of Archival Library & Museum Materials, State University System of Florida, accessed from www.uflib.ufl.edu/digital/collections/FLAP/.
28. From "Fort Myers in Vintage Postcards" by Gregg Turner, Arcadia Publishing, 2005.
29. From "Railroads of Southwest Florida" by Gregg M. Turner, Arcadia Publishing, 1999.
30. From "Fort Myers in Vintage Postcards" by Gregg Turner, Arcadia Publishing, 2005.



creating the plan 2

THE CHARRETTE PROCESS

The East Fort Myers Revitalization and Redevelopment Plan is the direct result of teamwork and collaboration. From June 6 – 12, 2008 community members came together, rolled up their sleeves, and worked alongside the planning team to create a plan for the future of the area. Organized as a design charrette, the week was filled with a variety of events to gain public input and to review the progress of the plan as it was being created. Over 200 residents, business owners, developers, and City leaders participated in the planning process. The result is a dynamic plan that builds upon the strengths of the community and focuses efforts on areas in need of improvement. Working together as a community is the best way to guide appropriate growth and assure quality development for future generations of East Fort Myers residents; the East Fort Myers Revitalization and Redevelopment Plan demonstrates just this kind of teamwork.

Prior to the charrette, the Dover-Kohl team focused their efforts on gathering base information and studying the existing physical conditions of the area. This included learning about local history, reviewing previous plans and studies, examining existing City ordinances and land development regulations, and analyzing the physical, social, and economic characteristics of East Fort Myers. A more detailed overview of the team's review of background information can be found in Chapter 1.

Members of the team visited Fort Myers throughout the spring of 2008 and met with City officials, Community Development staff, property owners, business owners, and other local stakeholders in preparation for the charrette. The meetings and interviews helped the team to better understand the dynamics of East Fort Myers.

A key element in preparing for the charrette was generating public awareness. City staff spread the word about the planning process by including ads in the local newspaper, posting public notices, generating extensive mailings, going door to door to businesses and homes, and by arranging for radio interviews with the planning team. These advertisements and marketing efforts were conducted in English and Spanish.

What is a Charrette?

Today, "charrette" has come to describe a rapid, intensive and creative work session in which a design team focuses in a particular design problem and arrives at a collaborative solution. Charrettes are product-oriented. The public charrette is fast becoming a preferred way to face the planning challenges confronting American communities.



Figure 2.1: Community members worked together to shape the plan for East Fort Myers.

City of Fort Myers
invites you to participate in creating the
East Fort Myers Revitalization & Redevelopment Plan
June 06 – 12, 2008

Community Kick-off Presentation
Friday, June 6th from 6:30 pm to 8:00 pm at AFCAAM (3681 Michigan Avenue).
Join us for an informative presentation on the planning process & traditional town planning.

Hands-on Design Session
Saturday, June 7th from 9:00 am to 2:00 pm at AFCAAM.
Come work alongside your neighbors to help create the plan for the future of East Fort Myers!

Open Design Studio
Monday, June 9th through Wednesday, June 11th from 9:00am to 7:00pm at Lee County/City Annex (1825 Hendry Street, 2nd Floor Conference Room).
Stop-by throughout the week and provide your input on the plan.

"Work-in-Progress" Presentation
Thursday, June 12th from 6:00 pm to 8:00 pm at City Hall.
See all of the work completed during the week at the "wrap-up" presentation.

Figure 2.2: The City mailed postcards to property owners and residents to announce the events.

TOURING THE STUDY AREA

In order to better understand East Fort Myers the team toured the study area and outlying neighborhoods. The team performed a detailed analysis of the various neighborhoods, corridors, and districts within the study area. The routes were coordinated both by the team and by City staff, who led the tour of East Fort Myers, highlighting areas of particular concern or interest.

During these tours, team members walked and recorded the existing conditions of the area through photographs, maps, and measurements. The team identified and took pictures of natural areas such as the Caloosahatchee River and Billy's Creek, streetscapes, buildings, architectural details, and unique conditions and characteristics that would influence the plan. The team also toured large, vacant properties and areas of blight. The planners and designers also used base maps on their tour, examining the existing urban fabric and analyzing the network of streets, blocks and lots, building types, and building forms. The team documented potential areas for infill development and redevelopment. Particular characteristics such as vacant buildings and storefronts, development activity, maintenance, and street activity were noted.

Because the tour was lead by a City of Fort Myers Law Enforcement Officer, the team was able to observe the particular relationship between crime and the design of the built environment. The team learned how the lack of landscape maintenance was causing pedestrians who cross the rail line to be vulnerable to assault. Likewise, dead-end streets and buildings that have blank walls seemed to encourage stagnation while discouraging natural surveillance.

The team was also lead to the pristine areas which provide precious habitat for creatures and plants, but are also valuable as recreational places. By visiting the oak hammock at Shady Oaks Park, exploring the boardwalks that wind through the mangrove jungle at the banks of Billy's Creek, and strolling along the Tarpon Street Pier, the planners began to understand the rare beauty of the study area, and how this natural beauty exists in close proximity to areas suffering economic hardship. The tour caused caused the planners to wonder if the value of experiencing these natural systems could be one of the keys to making East Fort Myers a target of investment and pride once again.



Figure 2.3: The Dover-Kohl team analyzed site data while studying the existing rail line.



Figure 2.4: The team visited the Billy's Creek overlook at Shady Oaks Park.



Figure 2.5: The team visited struggling neighborhoods.



Figure 2.6: A potential site for a park was identified.



Figure 2.7: The Law Enforcement Officer informed the team about code violations.



Figure 2.8: The team admired the natural beauty of the River from the Tarpon Street Pier.

THE KICK-OFF PRESENTATION

A *Kick-off Presentation* marked the beginning of the planning process. On Friday, June 6 interested citizens gathered for the evening at the African Caribbean American Center (AFCAAM) for an informative presentation on traditional town planning, neighborhood revitalization, sustainable development, and creating walkable places. Councilman Warren Wright welcomed the crowd and stressed that the time is now to plan for an improved East Fort Myers. Victor Dover, Principal of Dover, Kohl & Partners, and other team members delivered a highly-visual presentation and reviewed the schedule of events for the week. At the end of the presentation, a short survey was distributed and participants voiced initial thoughts, questions, and ideas during an open microphone session.

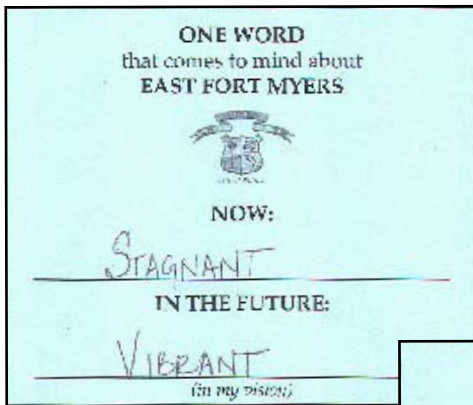

Figure 2.9: At the Kick-off Presentation, residents were asked to write one word to describe East Fort Myers now, and how they envision the area in the future.

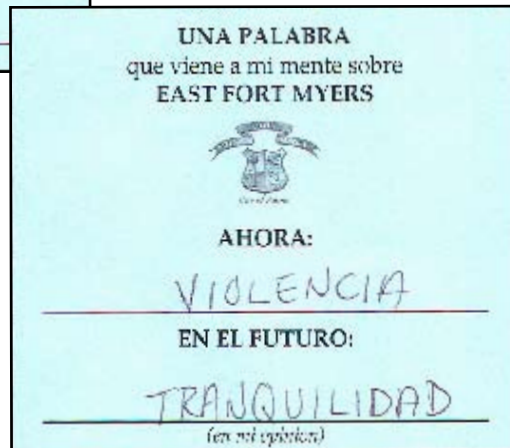

Figure 2.10: Councilman Warren Wright welcomed the community to the Kick-Off Presentation.



Figure 2.11: Members of the community voiced their ideas and concerns for East Fort Myers.



Figure 2.12



Figure 2.13



Figure 2.14



Figure 2.15

HANDS-ON DESIGN SESSION

On Saturday, June 7th, community members gathered at the African Caribbean American Center (AFCAAM) for the *Hands-on Design Session* from 9:00 am to 2:00 p.m. The event began with a short introduction and briefing by Victor Dover to further explain the challenge for participants, orient participants to base maps, and set ground rules and goals for the session. Working in small groups of approximately five people per table, participants gathered around tables to draw and share their varied ideas for the future of their neighborhoods and the Palm Beach Boulevard corridor. Each table was equipped with base maps, markers, and aerial photos of the study area. A facilitator from the Dover-Kohl team was assigned to each table to assist participants in the design exercises. At least one table was conducted entirely in Spanish, assisted by members of the design team and Planning Staff.

During the first part of the table sessions, community members identified the special areas and important issues associated with the overall future of East Fort Myers. Participants actively drew on base maps to illustrate how they might like to see the community evolve in the future by describing the uses, open spaces, building design, street design, transportation, and services for the area. During the exercises, the table groups identified specific redevelopment areas along the corridor. At the end of the workshop, a spokesperson from each table reported their table's ideas for the revitalization plan to the entire assembly. Of the many ideas heard, some of the most widely shared ideas included:

- Create additional public access points to the Caloosahatchee River
- Revitalize Palm Beach Boulevard
- Create more public parks and green spaces

In addition to the ideas generated during the Hands-on Design Session, a survey was distributed and completed by over 500 East Fort Myers' residents and business owners. Initial results showed that the most negative impact on quality of life in East Fort Myers is crime while one of the most positive impacts is the affordability of housing. When asked about which activities could improve the quality of life, the most common answers included trails (walking/biking), kids' activities, movie theaters, and cultural amenities. With regards to the types of businesses residents would support, over 50% of respondents identified a movie house, high-end restaurants, and bookstore. The surveys helped to gather a wide variety of input and provided the design team with a better understanding of the wants and needs of the community.



Figure 2.16: Victor Dover welcomed the community to the Hands-on Design Session.



Figure 2.17: Team member Rick Hall gave a brief presentation on walkable street design.



Figure 2.18: Preparing to draw



Figure 2.19: Discussing ideas



Figure 2.20: Residents and business owners worked together and shared ideas for the future of their community.



Figure 2.21: Table conducted in Spanish



Figure 2.22: A sample of table drawings



Figure 2.27: Community members working on a specific area of the plan.



Figure 2.23



Figure 2.24



Figure 2.25: Table leaders presented their table's ideas to the group.



Figure 2.26

p.5

Plan para la Revitalización y Reconstrucción de East Fort Myers
Fort Myers, Florida
Manos a la obra; Sesión de Diseño
Junio 7, 2008

1. Vives o trabajas en East Fort Myers? (Por favor marca)

Vives Trabajas Ninguna

Si vives o trabajas aquí: ¿Desde hace cuanto tiempo?

20 años

2. ¿De todas las ideas que escuchaste hoy, cuál fue la que más te gustó?

Áreas recreacionales
Mesas 9

3. ¿Cuál es tu visión para el futuro de East Fort Myers?

mejor economía

4. ¿En el futuro, que usos deberían agregarse a East Fort Myers?
(Por ejemplo: usos cívicos, distintos tipos de negocios, etc.)

Servicios de emergencia

5. ¿Tienes algún comentario adicional?

cuan to tiempo tomará para mejor

Si tienes otros comentarios por favor crédenlos
¡Muchas gracias por tu colaboración!
Por favor deja esta hoja en la mesa de contacto o envíala
Para mayor información, llama a: Kinsha Cynamon, Ciudad del
Diseño

Questionnaire #1

East Fort Myers Revitalization & Redevelopment Plan
Fort Myers, Florida
Hands-on Design Session
June 7, 2008

1. Do you live or work in East Fort Myers? (please circle)

Live Work Neither

If so, for how long?

2. Of the many ideas you heard today, which ones seem most exciting to you?

Community involvement in the future of EFM

3. What is your vision for the future character of East Fort Myers?

a diverse community, working toward becoming one people, walking towards positive goals, for the common good.

4. What uses do you feel should be added to East Fort Myers in the future (for example: civic uses, types of businesses, shops, housing, open space, etc.)?

Colleges.

5. Additional Comments (continue on back if needed)

Don't forget to include the natives of the area in the decision making process.

Please write any additional comments on the back of this sheet. Thank you for your help and your ideas!

Please leave this on the table at the door or fax to us at 239-461-2364. For more information, call Kinsha Cynamon, City of Fort Myers, 239-461-2695.

KCS

Figure 2.28: Sample exit surveys from the Hands-On Design Session.

THE DESIGN STUDIO

From Monday, June 9 through Wednesday, June 11 the design team continued to work with the community in an *open design studio* at the Lee County/City Annex building on Hendry Street downtown. Citizens and local leaders were encouraged to stop by the studio throughout the week to check the status of the plan, provide further input, and to make sure the design team was on the right track. The table drawings and plans from the Saturday design session were placed around the room for easy review as new people became involved. While community members visited the studio, the design team continued to analyze the information gathered at the hands-on session and site analysis in order to formulate the initial concepts for the plan. The team was tasked with synthesizing the many ideas heard from the community throughout the week into a single, cohesive revitalization plan. The planners and designers created lists, diagrams, drawings, and plans, working to combine and refine the ideas. Working in Fort Myers allowed the design team ready access to the study area during all hours and on different days of the week.

In addition to the open design studio, members of the design team met with community stakeholders and experts in scheduled technical meetings. The meetings were used to answer design questions, discuss the draft plan, and further gain input in regards to details associated with the redevelopment of the corridor and neighborhoods. Technical meetings included sessions with City staff, elected officials, business owners, developers and property owners. The technical meetings helped to further shape the detailed elements of the plan and to ensure that the ideas being processed were balanced by awareness of many viewpoints.



Figure 2.29: Dover-Kohl team members sketched initial ideas for infill development along the corridor.



Figure 2.30: Mayor Humphrey visited the studio to review the initial ideas for the plan.



Figure 2.31: Joe Kohl worked on design alternatives for Palm Beach Boulevard.



Figure 2.32: Technical meetings during the week helped to shape the details of the plan.



Figure 2.33: Members of the community stopped by the studio.

THE WORK-IN-PROGRESS PRESENTATION

The charrette concluded with a *Work-in-Progress Presentation* at the June 12th City Council Workshop. Mayor Humphrey began the workshop by acknowledging the dedication of the community and expressed his excitement for a revitalized East Fort Myers. Bill Spikowski of Spikowski Planning Associates, Victor Dover, and Andrew Georgiadis, Project Director for Dover-Kohl, then walked the audience through the various plan concepts. The plans presented a synthesis of the ideas voiced by the public throughout the week, merged with professional planning knowledge from the design team. A Four-Point Strategy was outlined and initial steps for implementation were identified. Recommendations for an improved Palm Beach Boulevard were discussed and detailed plans and illustrations helped all to better visualize the potential for the area. Understanding that the implementation of the plan will not happen overnight, the team provided drawings of both short and long-term changes that could be possible. At the conclusion of the presentation an exit survey was distributed and participants were invited to take a closer look at the plan and discuss their initial reactions with the team. Of the surveys received, 85% said that the plan was on the right track.

AFTER THE CHARRETTE

At the conclusion of the week-long charrette, the design team returned to Miami and produced a charrette bulletin that documented the initial ideas and drawings from the charrette. This bulletin was printed and widely distributed by City officials to increase public awareness and solicit further citizen input on the plan. The plans and illustrations were also refined to reflect input at the close of the Work-in-Progress Presentation. East Fort Myers residents were asked to continue to provide input on the draft plan; the charrette bulletin was made available for review at the Community Development Department and on the City of Fort Myers website.

On September 8, 2008, representatives from the Dover-Kohl team returned to Fort Myers for a Council Meeting, to gather further input from the City Council, Mayor, and City Manager. The team received suggestions and comments on how to improve the master plan and reviewed community initiatives and ideas that had arisen in the months following the charrette.



Figure 2.34: Bill Spikowski introduced the implementation strategy for East Fort Myers.



Figure 2.35



Figure 2.36



Figure 2.37



Figure 2.38 Community members asked questions and offered comments at the end of Work-in-Progress Presentation.



Figure 2.39



demographics and survey results 3

REVITALIZATION: WHAT IT MEANS

Revitalization is more than economic development. It is a process of empowering residents by soliciting and incorporating their input in solution strategies, and providing opportunities for participation in plan implementation. Ultimately, it is about identifying and delivering an acceptable quality of life to members of a community. This embraces all areas of life, including housing, transportation, recreation, retailing, entertainment, social support, health care, education and training, safety and security, physical fitness, and creative and performing arts.

Successful revitalization is not based on unrealistic dreams. Rather, it must reflect the dynamics of community demographics, a realistic identity of the community, socio-economic realities, and build on the comparative advantages the community possesses. For example, East Fort Myers possess attributes that should be the envy of other Southwest Florida communities: scenic waterways and access to the Gulf of Mexico, historic buildings that are both instructive and a source of pride, a central location, and residents and stakeholders who care deeply about and are interested in investing in its future. More importantly, successful revitalization is needs driven, and reflects proactive community buy-in and participation in well thought-out revitalization efforts.

Study Area

Figure 3.1 shows the boundaries of the East Fort Myers study area and the Census Block Groups within the area. The study area is a 1,039-acre (1.62 square mile) neighborhood bounded by Billy's Creek to the south and west, the Caloosahatchee River to the north, and Prospect Avenue (city limits) to the east. The 2000 population of the East Fort Myers study area was 6,720, representing 13.9% of the City's population at that time.

Palm Beach Boulevard is the primary east-west artery that bisects the residential neighborhoods to the north and south. The East Fort Myers study area is the most racial-ethnic diverse community in the City of Fort Myers. Estimated 2007 population was Blacks/African-Americans 33.6%, Whites 42.1% and Hispanics 39.9%.

The foreign-born members of the Hispanic group originate from four distinct regions. There are North American Hispanics, a group comprised solely of Mexicans. Central American Hispanics in the study area are represented mostly by Guatemalans, Hondurans and Salvadorans. Hispanic Caribbeans are represented mostly by Puerto Ricans. South American Hispanics have a smaller representation in the study area than the aforementioned groups. Non Spanish-speaking Latin Americans are also present to a limited extent, further enriching the cultural and linguistic landscape of East Fort Myers.

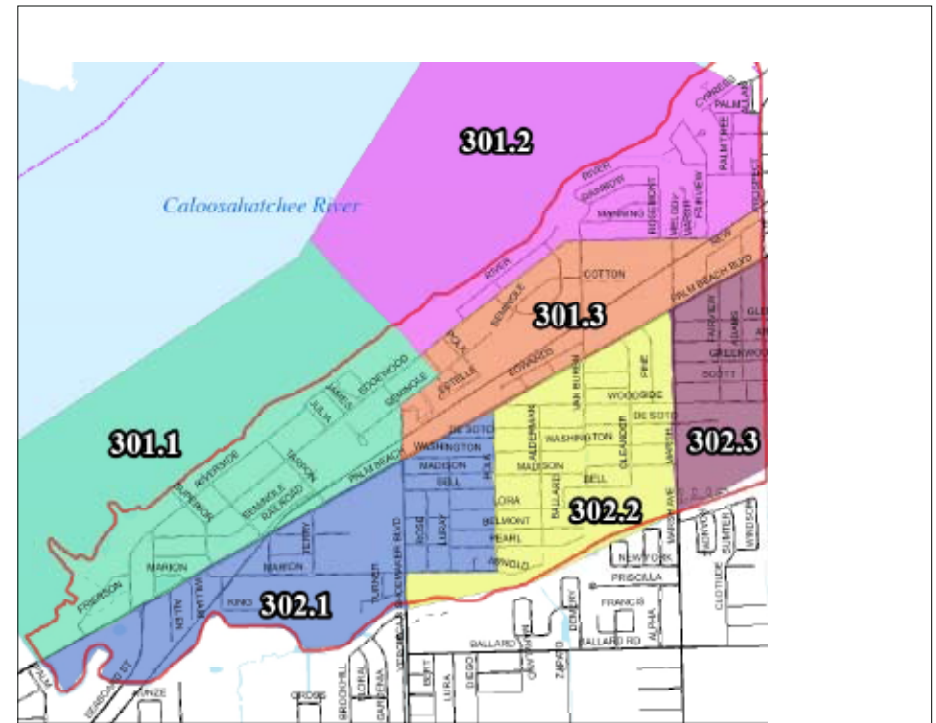

Figure 3.1: Study Area Boundary and Census Block Groups

The term “Latino” can broadly refer to Latin Americans who speak Spanish, although some would accept a broader definition that includes anyone who originates in the Americas and who speaks a Romance language. “Hispanic” refers to Spanish-speaking persons of Latin America. “Hispanic” and “Latino” are not interchangeable terms, and the definition may evolve as groups identify or chose not to identify with either term.

As in many other communities in the United States, East Fort Myers' Hispanics and Latin Americans tend to have a younger population, larger household size, and lower household income than other demographic groups. Most Latino residents in East Fort Myers are relatively recent arrivals in southwest Florida. The heavy concentration of Latinos in Southwest Florida is consistent with Florida's status as a gateway state for Latin American immigrants, and more locally, with Southwest Florida's extensive and diverse agricultural activities.

While many Latino residents are agricultural workers, many of them are also occupied in construction and lawn maintenance/landscaping. It is important to note that many Latino residents walk or use bicycles to access services both within and outside of the study area.

Many of these residents both own and support Latino commercial establishments along Palm Beach Boulevard such as supermarkets and restaurants. The amalgam of Latino cultures is an important shaping influence on the culture of East Fort Myers.

Research Process

Two primary data acquisition approaches drove this revitalization effort. The first was a carefully-designed survey that collected data using a questionnaire. This research allowed a wide net of community members to reflectively and objectively assess community needs, collectively identify issues, and suggest activities and approaches to achieving a desired quality of life for East Fort Myers. The second approach employed the Charrette process where community members and other stakeholders, working together in-place, both identified issues that adversely affected attainment of a desired quality of life, and suggested approaches to transform these issues in order to achieve the contours of the community of their future. These inputs, which reflected both individual and community interests, guided the efforts of the planning design team. Many respondents to the survey also participated in the Charrette.

Research Design

Two data collection approaches were used to support the survey research.

1. *Random sampling.* Almost 390 households and businesses were randomly selected and surveyed using a self-administered questionnaire. Both English and Spanish versions of the questionnaire were used (see appendix D). The survey was designed to achieve an accuracy of +/- 0.5%.

2. *Convenience sampling.* Using a self-administered questionnaire, this approach collected data from 98 respondents including:

- a. City/County staff and officials that are involved with the target area.
- b. Residents/owners/business leaders that attended the Charrette and revitalization sessions; and

- c. Clients-residents of the area, and employees of service organizations that do business in the target area; e.g., Lee Elementary School, AFCAAM, Catholic Charities, and Nations Association.

Statistical comparisons of the results from both data sets showed no significant differences. Thus, the combined sample of 488 was pooled for this research.



Figure 3.2: Dr. Duffus distributed questionnaires to community stakeholders.

SURVEY RESULTS

Positive Attributes of the Study Area

Table 3.1 shows the top ten items that were identified by survey respondents as improving the quality of life in East Fort Myers. Except for affordability of housing, access to housing/retail services, riverfront activities, and cultural diversity, the other items are related to access to public infrastructure and services. Almost thirty-six percent (35.9%) of respondents identified affordability of housing as the top item. This was followed by access to Interstate 75 and proximity to downtown Fort Myers.

Rank	Variables	Frequency ²	Percent
1	Affordability of housing	175	35.9%
2	Access to Interstate 75	142	29.1%
3	Proximity to downtown Fort Myers	136	27.9%
4	Access to shopping/retail services	140	28.7%
5	Availability of public transportation	118	24.2%
6	Cultural diversity	99	20.3%
7	Access to government/public services	95	19.5%
8	Access to good schools/quality education	76	15.6%
9	Access to fire/ambulance services	85	17.4%
10	Access to riverfront activities	44	9.0%

¹ - N = 488 Responses

² - Number of times the variable was identified by the 488 respondents

Perhaps the most gratifying result concerns cultural diversity, where over twenty percent (20.3%) of respondents selected it as positively affecting the quality of life in East Fort Myers. Despite the race/ethnicity distribution – White/Caucasians (43.3 %), Black/African-American-Americans (29.0 %), and Hispanics (26.3%) – approximately the same percentage of support for cultural diversity came from each group.

In general, distribution of responses was similar for each racial/ethnic groups. Where differences exist, the variable-group (s) responses that were highest are:

- Affordability of housing - Blacks/African-Americans (41.1%); Hispanics (43.8%)

- Access to shopping retail/services - Hispanics (39.1%)
- Availability of public transportation - Hispanics (32.8%)
- Access to riverfront activities - White Caucasians (17.1%)

Among respondents who identified affordability of housing as negatively affecting the quality of life, 43.7% have resided in the community less than 8 years, 46.9% live in rented accommodation, and 42.1% have weekly household income of \$401- \$1,200.

Characteristics that Adversely Affect Quality of Life

Table 3.2 shows the top ten items that were identified by survey respondents as having an adverse affect on the quality of life in East Fort Myers. Crime/crime rate is identified as having the most important adverse affect on the quality of life. As discussed elsewhere in this report, homicide, theft, drug-use, and vandalism have stigmatized the study area, even though crime statistics have shown slight improvement during recent months. Except for road/traffic conditions, which speak to the impact of the newly installed median on accessibility and business performance on Palm Beach Boulevard, the information identified are symptomatic of increasing blight and neighborhood decline. The results confirm the findings of a recent study (*East Fort Myers Blight Study*), which provided data demonstrating conditions of blight throughout the study area.

Rank	Variables	Frequency ²	Percent
1	Crime/crime rate	218	44.7%
2	Dirty streets/yards	144	29.5%
3	Availability of jobs/employment opportunities	125	25.6%
4	Adequacy of policing	101	20.7%
5	Concentration of immigrants	100	20.5%
6	Multiple families in single family homes	99	20.3%
7	Road/traffic conditions	89	18.2%
8	Language barrier of some residents	84	17.2%
9	Used automobile lots	67	13.7%
10	Quality of retailing	61	12.5%

¹ - N = 488 Responses

² - Number of times the variable was identified by the 488 respondents

Adverse Affect of Blight

A “blighted” area means an area in which there are a substantial number of deteriorated or deteriorating structures, in which conditions, as indicated by government-maintained statistics or other studies, are leading to economic distress or endanger life or property. Two or more of the following factors must be present, as required by Florida Statute 163.3140(8):

- a. Predominance of defective or inadequate street layout, parking facilities, roadways, bridges, or public transportation facilities;
- b. Aggregate assessed values of real property in the area for ad valorem tax purposes have failed to show any appreciable increase over the 5 years prior to the finding of such conditions;
- c. Faulty lot layout in relation to size, adequacy, accessibility, or usefulness;
- d. Unsanitary or unsafe conditions;
- e. Deterioration of site or other improvements;
- f. Inadequate and outdated building density patterns;
- g. Falling lease rates per square foot of office, commercial, or industrial space compared to the remainder of the county or municipality;
- h. Tax or special assessment delinquency exceeding the fair value of the land;
- i. Residential and commercial vacancy rates higher in the area than in the remainder of the county or municipality;
- j. Incidence of crime in the area higher than in the remainder of the county or municipality;
- k. Fire and emergency medical service calls to the area proportionately higher than in the remainder of the county or municipality;
- l. A greater number of violations of the Florida Building Code in the area than the number of violations recorded in the remainder of the county or municipality;
- m. Diversity of ownership or defective or unusual conditions of title which prevent the free alienability of land within the deteriorated or hazardous area; or
- n. Governmentally owned property with adverse environmental conditions caused by a public or private entity (Source: *East Fort Myers Blight Study*).

The term “blighted area” also means any area in which at least one of the factors identified in (a) through (n) are present and all taxing authorities subject to s.163.387(2)(a) agree, either by interlocal agreement or agreements with the agency or by resolution, that the area is blighted. Such agreement or resolution shall only determine that the area is blighted. For purposes of qualifying for the tax credits authorized in chapter 220, “blighted area” means “an area as defined in this subsection.”

Blighted areas constitute an economic and social liability, imposing burdens that decrease the tax base, reduce tax revenues, substantially impair sound growth and socio-economic revitalization, and retard provision of housing solutions. Unfortunately, blighted areas endanger residents living in them by becoming focal centers of disease and crime, promoting juvenile delinquency, and consuming an excessive proportion of local governmental revenues because of the extra services required for police, fire, accident, hospitalization, and other forms of public protection, services, and facilities.

East Fort Myers contains a staggering inventory of empty lots (nearly 18% of the lots within the study area are vacant) and other properties that are ready for re-development. The large number of abandoned and boarded up premises affords an opportunity for “development by demolition”, and consolidation into larger properties. This has the advantages of removing unsafe structures and vacant and abandoned property which can become havens for crime infestation and blight. The larger parcels that result could be used as sites for community parks and green-space development. Also, the consolidation of lots can facilitate more expeditious future city-private sector partnerships for mixed-income, mixed-use, mixed-design development.

As the City of Fort Myers tighten budgets amid a slowing economy, preventing vacant homes from falling into decay and dragging down property values is becoming increasingly difficult. Many homes will remain empty for months, if not years, while the housing market recovers, potentially becoming objects of blight and targets for vandalism and theft.

Crime/Crime Rate

As shown in Table 3.2, almost forty-five percent (44.7%) of respondents identified crime/crime rate as having a adversely affect on the quality of life in East Fort Myers. Indeed, crime/crime rate was selected by a margin of 1.5 to 1 over the next highest issue, dirty streets/yards.

The perceptions of high crime/crime rate are broad-based, and reflected in the data collected from the diverse East Fort Myers groups and communities. For example, the percentage of Whites/Caucasians, Blacks/African Americans and Hispanics that perceive crime/crime rate as problematic are 40.8, 54.6, and 37.8 respectively. Perceptions of crime/crime rate by length of years resident in the community, race/ethnicity, type of employment, type of residential accommodation, and income levels are:

- Race Ethnicity: White/Caucasians (40.8%), Blacks/African-Americans (54.6%), Hispanics (37.8%).
- Years resident in East Fort Myers: Less than 8 years (38.1%), Eight years or more (49.8%).
- Type of employment: Management (40.0%), Others (45.3%).
- Type of Residential Accommodation: Own (45.0%), Rent (43.0%).
- Weekly Income Level: Under \$401 (58.2%), \$401-\$1,200 (44.2%), Over \$1,200 (40.5%).

The highest level of concern about crime/crime rate was reported by Blacks/African-Americans, longer-term residents in the community, and residents earning the lowest weekly income.

Challenges and Opportunities of High Levels of Crime

Community perceptions about crime/crime rate constitute both a challenge and an opportunity. The challenge arises from the reality that over time, crime or perceptions of high crime or crime rate tends to sap the socio-economic life chances of a community. Consequences are fear and apprehension, outward mobility by those who can, decreased investment, and continued socio-economic degradation.

Fortunately, the downward spiral to socio-economic despair does not appear to have been reached in East Fort Myers. Evidence of this abounds in the high levels of community involvement and activism in support of crime abatement measures, and more recently, business issues related to the reported adverse affect on business performance of the recently installed median along Palm Beach Boulevard.

Perhaps the most visible sign of this robust entrepreneurship reside in the many business persons and entrepreneurs who actively participated in helping structure the revitalization effort to promote a more hospitable climate for investment in the community.

Challenge also comes from communications pointing to both reduction in murders and increase in total number of crimes. For example, according to the News-Press, murders decreased from 14 to four in the first five months of 2008 as compared to the same period last year (News-Press, 6/19/2008). Fort Myers Police Department (FMPD) reports that, citywide, Uniform Crime Reporting (UCR) crimes (e.g., murder, sexual battery, aggravated assault, theft, etc.) increased 12.7% in 2007. In addition, the total number of crimes increased from 3,874 to 4,364. The increase follows a significant downward trend in crimes, where UCR crimes plummeted 53.4% between 2000 and 2006 (*FMPolice.com*). Because of boundary changes between 2000 and 2006, disaggregated statistics by Ward are unavailable until 2006. As shown in Table 3.3, during 2007, UCR crimes in Wards 1 and 2, which covers the target area, increased 8.3% and 2.1% respectively.

Area	2006	2007	Change (%)
Citywide	3874	4364	12.65
Ward 1	446	483	8.30
Ward 2	520	531	2.12
Ward 3	660	689	4.39
Ward 4	508	547	7.68
Ward 5	318	372	16.96
Ward 6	1278	1633	27.78

¹ City of Fort Myers Police Department

Even though increases in crime citywide significantly exceeded the target area, there remains an enduring perception among East Fort Myers residents and business leaders that crime is high in the area.

Area	1/1/07 - 6/30/07	1/1/08 - 6/30/08	Change (%)
Citywide	2103	1960	- 6.8
Ward 1	238	198	- 16.81
Ward 2	274	199	- 27.37
Ward 3	343	304	- 11.37
Ward 4	267	223	- 16.48
Ward 5	163	147	- 9.82
Ward 6	741	864	16.60

¹ City of Fort Myers Police Department

Also of interest is the reality that Citywide, UCR crimes decreased almost seven percent (6.8%) for the first half of 2008. Equivalent decreases for Wards 1 and 2 was 16.8% and 27.4% respectively (Table 3.4). Speculation is that the high crime perception is fed both by extensive media coverage and the recency of several shootings.

Despite FMPD's pro-activity in fighting crime, there is an enduring negative perception of the "police" and other "authorities" by major sections of the community that feeds an already high level of distrust for the "police." For example, during discussions with respondents during the survey, some unoccupied youths speculated that the "police just drive by, looking to harass us," while another expressed apprehension based on perceptions of a linkage between police and the Department of Homeland Security (for fear of deportation).

The Road Ahead in Addressing Issues of Crime/Crime Rate

The FMPD is aware of these negative perceptions and has been proactive in efforts both to turn this around and serve the community in ways which ultimately will enhance crime prevention and public safety by further reducing the level of crime. Strategies being utilized reflect the recognition that most crimes of opportunity are committed by young people, aged 14 to 22. The FMPD employs specific targeted programs, designed to provide constructive outlets for youthful energy, and expose youngsters to police officers as role models of success. Community/youth development programs sponsored by FMPD include: Police Athletic League (PAL), DARE, Do the Right Thing, Respect for Law Camp, and Explorer Program.

Too often, much of the crime is attributed to the sheer poverty of the area, economic instability, population increases, and the transient nature of the community. The research suggests several fruitful opportunities for improved community-police relations, some of which are already being employed, such as the red wristband "Stop the Violence" campaign. More proactive policing; swift, targeted, and proportionate reaction; community-police relationships which co-ops the public as an important and respected part of the crime fighting team; and, better marketing will both help tamp down the level of crime within the community and help build "trust" of the police.

AVAILABILITY OF EMPLOYMENT OPPORTUNITIES

Low income levels, economic instability, crime, the transient nature of the community form the social context of this plan. The implementation of the plan needs to be pursued with a vigor that is proportionate to the size of the problems. Some solutions are short-term, such as measures to deter crime through environmental design. Other solutions are long-term and involve changing the mindset of the place, how residents view themselves, and how their relationship with law-enforcement can progress to a state of collaboration and friendship.

The East Fort Myers community is characterized as having an economy with above normal percentages of transient labor, temporary employment, and low wage service, construction, and maintenance jobs. Consequently, it has been particularly susceptible to the housing market-based economic downturn.

An important ingredient of economic revitalization of any community is the availability of stable and suitable employment opportunities for residents. The explicit identification of and high ranking of job/employment opportunities as adversely affecting the quality of life in East Fort Myers is one indication that currently, this condition does not exist.

Focus on Identity-Based Development

The economic downturn has served to highlight the area dependence on the housing-real estate markets. Economic transformation will require a mix of more stable and high value added jobs. The road ahead will be difficult. Suggestions of high-technology jobs are unrealistic since the area lacks the critical infrastructure; e.g, a research university to support that type of development. Other suggestions include a more upscale retail presence. While strategically this has merit (after development of towns in lower Charlotte County and northern Lee County), current area economics will not support that type of development. Instead, appropriate development and revitalization should be dictated by the comparative advantages of the area; e.g., the River-side to Creek-side identity of the area, and the housing, economic, and recreational opportunities that this identity engender.

Emphasize Assistance to Small Businesses

Throughout the community, small business concerns remain a vital sector in providing broad-based employment opportunities. The East Fort Myers commercial sector is comprised primarily of small businesses. Many lack the resource and management capabilities and depth to successfully address the challenges and opportunities of a revitalized community.

Expanding the number and profile of local businesses will provide more consumer choices to local businesses, offer more opportunities for entrepreneurial activities, allow retention of more wealth in the community, and increase the tax base. Thus, business training and start-up facilities are important for launching new businesses and nurturing others to success.

The City of Fort Myers should continue to support and publicize the entrepreneurial assistance programs for small businesses; e.g., assistance in developing business and marketing plans, office space, parking, utilities, meeting rooms, shared secretarial services, etc. Such programs are offered, often at little or no cost by the Southwest Florida Enterprise Center, Lee County School System High-Tech Center (located on Michigan Avenue), and Florida Gulf Coast University's Small Business Development Center.



Figure 3.3: Southwest Florida Enterprise Center

ROAD/TRAFFIC CONDITIONS

Road/traffic conditions are probably the most contentious and politically explosive issue among area residents and business persons. The contentiousness largely results from the recently installed median along Palm Beach Boulevard by the Florida Department of Transportation. Though installed as a means of reducing pedestrian accidents, the median has costly unintended consequences, including rerouting business traffic, impeding access to corridor businesses, and decreased sales. Businesses report sales decline of 20-50% YTD which they attribute to the “median” effect. Needless to say, the perceived “median-based” sales decline has triggered a range of conspiracy theories; e.g., the median is designed to choke-off business traffic and foster business attrition as step-one of a strategic upgrade of the corridor, and merchant emotions; frustration, helplessness, anger, and commitment to collective legal action.

Cost to Businesses of the Medians on Palm Beach Boulevard

An effort to assess the validity of claims of median-based business downturn was attempted for this study. This effort involved merchants’ assessment of the percent that business increased/decreased during the first six months of 2008 that they attributed to the medians. Merchants were asked to compare this increase/decrease to the same period in 2007. Based on a convenience sample of 16 businesses, the statistics showed a 19 percent sales decline for January to June 2008 compared to the same period in 2007. This preliminary effort to assess the validity of the claim of median-based decrease in sale performance suggests that it may have merit. However, given the various contributory factors, it is impossible to accurately estimate the magnitude of the downturn due to the “median effect.” For example, in addition to the reality that the statistics used are informed “guesstimates,” a major contributory factor is the struggling economy, which has caused a steep decline in revenue for business within the study area. Vacancy rates are high, with some rental communities reporting 25% plus vacancies, and a drive through the community show numerous single family houses boarded up and abandoned. Housing foreclosures are at an all-time high.

East Fort Myers, like many other communities across the country, is suffering from a wave of foreclosures and mortgage defaults that occurred during the sub-prime lending crisis. Numerous code violations for unsafe structures and the resulting liens on properties have contributed to the wave of foreclosures, scared investors, and a decrease in buyers looking to purchase a primary residence.

As shown in Table 3.5, in Ward 1, which comprises the bulk of the study area, 1 in 11 homes has experienced some form of foreclosure since January 2007.

There are anecdotal reports of large numbers of residents moving on to other areas, in search of work because of the downturn in the housing market. This situation will further aggravate both the foreclosure and economic situation. Another challenge is to separate the Palm Beach Boulevard sales changes from those due to extraneous factors such as the general sales decline. For example, one construction-related merchant with one Palm Beach Boulevard store and 4 other area stores (Lehigh Acres, Metro Parkway, Naples, and Bonita) found the following sales decline for the period January 1, 2008 to June 13, 2008 compared to the same period in 2007:

- Palm Beach Boulevard stores: 54.18%
- Other stores (average): 19.75%

To find the difference in decline between Palm Beach Boulevard stores and the other stores in the control group, the difference in decline is roughly 34%. This suggests that there is some other physical characteristic of the boulevard that is causing the businesses along it to fare worse to the businesses that they were compared to. Given the cumulative affect of the various contributory factors to the reported sales decline being experienced by businesses along the Palm Beach Boulevard corridor, it is likely that the median, as currently configured, is indeed affecting business performance. Merchants reported to the planning team that it is the primary complaint of their customers.

In an effort to address the increasing cacophony of concerns, merchants and City officials have had various meetings to craft an acceptable solution. A major problem concerns the dilemma of the state Department of Transportation being the key agency. In spite of this, numerous options, including modifications to the medians, have been suggested.

Ward	Foreclosures	Percentage of all CFM Foreclosures	Total Residential Units	% of Total Fore-closures on Total Residential Units	1 in X Homes under-going Foreclosure
1	226	15.72	2360	9.58	11
2	159	11.06	2322	6.85	15
3	178	12.38	2211	8.05	13
4	152	10.57	3097	4.91	21
5	135	9.39	2615	5.16	20
6	588	48.89	9511	6.18	17

¹ City of Fort Myers Community Development Department GIS (August-September 2008)

USED CAR LOTS

Survey respondents perceive that used car lots along Palm Beach Boulevard diminish the quality of life in East Fort Myers. At issue is the large number as well as the relatively unattractive appearance of some facilities along what is a major gateway to the City of Fort Myers. Proponents of this view suggest their relocation to a less conspicuous area or point to the need for other strategic solutions such as creation of an auto district containing:

- A cluster of used car sales and auto support services, or
- A multiple story-parking garage type auto mall.

Such facilities would not only contain the used car lots in an environment away from the gateway corridor, but would contain necessary support services; e.g., auto repairs, auto parts, food service, etc. They argue that this approach would offer better shopping choices, layout efficiencies and effectiveness, remove unsightly used car lots from along Palm Beach Boulevard, allow more effective utilization of Palm Beach Boulevard retail potential, provide enhanced used car retail effectiveness by providing comparison shopping in a smaller retail area, and facilitate better esthetic appearance along Palm Beach Boulevard. Ultimately, this approach is expected to facilitate greater sales volume to a regional instead of local target market.

Opponents of this approach point to the unavailability of suitable sized, low cost acreage in East Fort Myers, the huge investment required; e.g., it currently cost upwards of \$15,000 per car for a five-floor parking garage, and the difficulty of selling this approach to merchants who currently control choice real properties along the gateway corridors. Because of high traffic volume and conspicuous locations, used car lots and support services will continue to proliferate along Palm Beach Boulevard as long as the economic value of those lots remains low; but over time, market conditions will eventually see the lots transformed to more economic, higher value-added uses.

Another important issue concerns the long term economic benefit to the community of the proliferation of used car lots along Palm Beach Boulevard. According to an October 2008 study conducted by the City of Fort Myers, 36.2% of all auto dealers in the City are located along Palm Beach Boulevard. Together, these lots occupy 1.6 acres or 1% of total auto dealer acreage in the City. Economic returns from auto lots are a function of type of car sales; e.g., new or used, size, and location. This suggests that since, a) lots located along Palm Beach Boulevard are relatively small, and b) economic returns for new cars substantially exceed that of used cars, lots located along Palm Beach Boulevard do not generate the same level of profit as better located, larger dealerships that sell new cars. Because of



Figure 3.4: A typical car lot on Palm Beach Boulevard.

the bleak prospects for car sales in the coming years, especially gas-guzzling models that are the mainstay of many dealerships, it is doubtful whether car lots of any type can contribute to a robust economy along Palm Beach Boulevard. Additionally, car lots configured as surface lots tend to erode the urban fabric. They have a deadening effect upon pedestrian vibrancy by creating gaps in the street wall. A continuous street wall is the defining characteristic of any lively main street. Also, a car purchase is quite infrequent when compared to other day-to-day purchases. Thus car lots may inhibit retail and pedestrian vibrancy and convenience rather than enhance them. If car sales are to remain part of the retail mix along Palm Beach Boulevard, they should be accommodated in multi-story mixed-use buildings that shape the public realm rather than erode it.

BUSINESS THAT WOULD BE SUPPORTED

Table 3.6 shows the top seven items that the survey respondents would support. The top three items are cinema/movie house (74%), bookstore (68.4%) and high end family restaurants (65.8%).

No substantial differences exist among the various racial/ethnic groups in terms of the ranked responses. However, people with less than 8 years residents in the community offer stronger support for cinema/movie house (9/6 ratio), than persons resident in the area more than 8 years. Under 8 year residents also have stronger support for high end family restaurants (7/6 ratio) than persons resident in the area more than 8 years. On the other hand, residents would support the performing arts center by a ratio of 7/3 over persons resident in the area less than 8 years.

Rank	Variables	Frequency ²	Percent
1	Cinema/Movie House	361	74%
2	Bookstore	334	68.4%
3	High end family restaurants	321	65.8%
4	Performing Arts Center	174	35.7%
5	National Brand Hotel	112	23%
6	Supermarket	66	13.5%
7	Funeral Services	35	7.2%

¹ - N = 488 Responses

² - Number of times the variable was identified by the 488 respondents

Currently, the closest movie houses are located along US 41 in the vicinity of Edison Mall and at Bell Tower Mall, both of which enjoy high traffic and people flow.

The strong demand for cinema/movie houses highlights the reality that economic operation of cinema/movie houses increasingly dictates a focus on multiplexes which benefit from people-moving scale economies. Cinemas/movies are in fact people moving businesses. The more people move past the concessionary area (popcorn), the more profitable the organization. In the current business environment, the typical cinema is in fact three businesses: fast-food business (where the profit is made), the movie exhibition business, and the advertising business. Given the socio-economics of the target area, success of such

a facility would critically depend on increased mall/shopping traffic. Both appear unlikely in the current socio-cultural-economic environment as the area lacks the critical mass of retail and entertainment activities needed to attract persons from outside the area.

Bookstores perform a basic mediating role between a community and its residents in promoting learning and upward mobility. Stand-alone local bookstores are increasingly, falling prey to better resourced national chain ownership. Simultaneously, limited bookstore services are provided by other retailers; e.g., pharmacies, supermarkets, etc. which benefit from scale economies in delivering the service. Where chain bookstores are unprofitable, the service is provided by public libraries. The current socio-economics of the area is unlikely to support emergence and success of either local bookstores, or chain bookstores, which like cinema/movie houses, tend to make location decisions based on more favorable economics; high retail traffic, household income, traffic count, etc., than the area currently offers.

SOCIO-CULTURAL/RECREATIONAL/SPORTS ACTIVITIES

Kids' activities, trails for biking/walking/physical fitness, and cinema/movie house are the top socio-cultural/recreational/sports items identified as likely to improve the quality of life in East Fort Myers. Approximately thirty-eight percent of respondents selected these items, with the next items on the list, cultural programs and playing fields, garnering approximately twenty seven percent of responses. As shown on Table 3.7, there is thus a strong emphasis on recreational, youth-children programs and activities, cultural activities and entertainment.

Rank	Variables	Frequency ²	Percent
1	Kid's activities	189	38.7%
2	Trails for biking/walking/physical fitness, etc.	185	37.9%
3	Cinema/movie house	185	37.9%
4	Cultural programs	136	27.9%
5	Playing fields (e.g., soccer)	132	27%
6	Recreational activities	113	23.2%
7	Youth center	106	21.7%
8	Symphony/music/concert/arts	105	21.5%
9	Child care services	101	20.7%
10	Water-Related parks	93	19.1%

¹ - N = 488 Responses

² - Number of times the variable was identified by the 488 respondents

Leisure Activities

The range of responses to the survey (Table 3.7) is evidence that leisure activities are valued by the East Fort Myers community. Four of the top 10 items identified by the survey respondents directly relate to leisure activities; 38% want trails for biking/walking/physical fitness, 27% identified the needs for greenspaces - parks and playing fields, 23.2% identified the need for recreational activities, and 19.1% expressed a need for water-related parks. The strong leisure focus suggests a possible revitalization approach that capitalizes on the competitive advantages of East Fort Myers – the Caloosahatchee River and Billy's Creek.

The pervasive leisure focus suggests a vision of a River-side to Creek-side identity manifested in a trail-based infrastructure; a series of trails and walking paths that continues from downtown Fort Myers, along the river and creek, linking

the Caloosahatchee River environs to Billy's Creek, and giving definition and economic vitality to the entire community. It suggests a community with an enhanced focus on leisure activities; swimming, boating, jet skis, fishing, picnics, walking, kayaking, water sports, jogging, and physical health. And it suggests another path to a vibrant and unique economy that capitalizes of the competitive advantages of river and creek to both provide jobs in recreational activities, sports activities, parks, and restaurants and draw people to the community both as visitors and residents.

Youth-Children Programs and Activities

The population of East Fort Myers is both diverse and increasing. This diversity and increase is particularly evident among Blacks/African-Americans and Hispanics, as well as among children under 19 years old. For example, between 2000 and 2012, Whites/Caucasians are projected to increase 9.3% versus 58.4% for Blacks/African-Americans, and 63.6% for Hispanics. According to the 2007 estimate of the population, 34% are Whites/Caucasians, 42.1% are Blacks/African-Americans, and 39.9% Hispanic.

Similarly, the area's youth population is projected to increase significantly during the next few years. Reflecting this projected increase, in 2000, over 20 percent of persons living in East Fort Myers were under 19 years old. By the year, 2012, this age group is projected to increase 24%, and represent 30.7% of the population.

East Fort Myers has socio-cultural challenges that do not exist in other parts of the City of Fort Myers. Much of these derive from the racial/cultural diversity, rapid population increases in the Black/African American and Hispanic communities, as well as an influx of new immigrants striving to integrate into the community. These challenges relate to language, larger household, high population mobility, lower education and income levels, etc. This is particularly applicable to Hispanics households, where the average age is lower, household sizes are larger, household income lower, and there is an overemphasis on seasonal, construction, migrant-type occupations.

The expressed community need for youth and childcare services, sports and recreational activities, and other youth development programs must be evaluated in this dynamically cross-cultural context, as well as the reality that most crimes of opportunity are committed by young people, aged 14 to 22. Few targeted recreational activities exist, especially for youngsters in this critical age group.

ECONOMIC AND SOCIO-CULTURAL ACTIVITIES

Consistent themes of jobs, entertainment, safety-security, and children-recreation are reflected in the responses to the various questions. This is particularly so in survey Question 5, which asked respondents to identify the one Economic and Socio-Cultural Activities they would like to see in East Fort Myers, regardless of how much it costs.

As shown in Table 3.8 (Survey Question 5), respondents were decisive in identifying jobs as the socio-cultural activity they would most like to see in the community. This was selected by a margin of 3 to 2 over the second ranked activity, Law enforcement/police station. Other items included safe pedestrian crossing, public/government building, child centered parks, and cinema/movie house.

Rank	Variables	Frequency ²	Percent
1	More jobs nearby	106	21.7%
2	Law enforcement/police station	69	14.1%
3	Safe pedestrian crossing points on Palm Beach Boulevard	57	11.7%
4	Public/government service buildings	48	10%
5	Child centered parks	45	9.2%
6	Cinema/movie house	39	8%

¹ - N = 488 Responses

² - Number of times the variable was identified by the 488 respondents

Despite severe resource limitations, various community organizations, such as Nations Association, recognize the opportunities posed by these challenges and are proactive in efforts to meet the diverse youth development needs. Currently, they offer limited youth oriented programs, and expect to expand future offerings. One such organization, Boys and Girls Club of Lee County, currently offers programs for boys and girls aged – 7 to 18 at Shady Oaks Park. Offerings include Character and Leadership Development, Education and Career Development, Health and Life Skills, Arts, Sports, and Fitness and Recreation programs. The Boys and Girls Club is interested in partnering with the City of Fort Myers, in developing a Youth Center to be located at the Billy Bowlegs Park. This Center would both transfer current operations from Shady Oaks Park and implement and conduct a diversified range of programs and activities to meet the dynamic and growing needs and interests of the youths of East Fort Myers.

IMPLICATIONS ON REVITALIZATION

East Fort Myers is characterized by a diverse multi-cultural, multi-ethnic, and multi-racial, mix of residents and activities. It is a “community of communities” with a “river” to “creek” identity. Located mid-way between I-75 and downtown Fort Myers, it is bisected and commonly served by the Palm Beach Boulevard commercial and retail corridor.

The population includes an over representation of older and retired persons, and the average household income is lower than the City of Fort Myers. Despite the implacable advancement of demographics, East Fort Myers is expected to retain this character into the distant future.

The community perceptions identified by the research were combined with information from a) the charrette process (where residents and business leaders led the process of designing the community of their future), b) other prior East Fort Myers planning efforts, c) best design practices and standards, d) assessment of other similar communities and their promises and performances, and e) assessment of marketplace factors, transportation, public safety, and economic factors. Six steps to unlock the revitalization potential of East Fort Myers are presented.

1. Define the revitalization objectives. A suitable objective is:

- a. Transform East Fort Myers into a place-community where people *want* to live, work, and play.

2. Clearly outline community characteristics and define its identity.

Characteristics include:

- a. Convenient near-town location.
- b. Diverse community: multi-cultural, multi-ethnic, multi-racial.
- c. Gateway community.
- d. People live from the river to the creek.
- e. A culturally diverse community that includes Whites, African Americans, Hispanics and other groups.
- f. City Council, Planning Staff, residents, business owners and developers are all dedicated (and somewhat united) in the quest to revitalize East Fort Myers.
- g. Access to the Gulf of Mexico.

The geography provides an opportunity to capitalize on the uniqueness of the community and the competitive advantages provided by the Caloosahatchee River and Billy’s Creek to establish a desired and realistic community identity.

3. Provide proper government support. Examples include:

- a. A carefully designed zoning plan.
- b. Access to quality education and training.
- c. Access to government services.
- d. Modern and convenient transportation network.

Proper City of Fort Myers support would include guidance on acceptable types of development; zoning for mixed use development, river and creek access requirements for the public, building safety standards, etc.

Currently, residents perceive that access to downtown Fort Myers and the government and cultural services it provides enhances the quality of life in East Fort Myers. Emphasis is on convenience of services that are congruent both with community demographics; bimodal age distribution with large older and youth populations, low income, etc., and the identity-related revitalization.

Infrastructure such as primary-post secondary education is the purview of others, though the City can be influential in ensuring that East Fort Myers receives quality representation.

An infrastructure that supports the revitalization objective will facilitate self-improvement, ignite empowerment, open up the community through easy access to anywhere, and unleash the creativity productive resources of the community.

4. Strengthen and maintain public safety and crime prevention.

- a. Develop, maintain and strengthen police-community relationships.
- b. Create an climate for reduced levels of crime and violence; involved and empowered community, proactive policing. strong police-community relationships, etc.
- c. Maintain a visible and permanent police presence.
- d. Develop and maintain strong police-youth interactions.
- e. Market the service and protection function and its results.

Rather than a Public Information Office whose primary responsibility is media relations with a focus on burnishing the image of the FMPD (public relations), the FMPD should reorganize its public communication face to explicitly include a marketing function (or Department) with a focus on providing needs driven service to the community. Separate from the crime prevention, and public safety functions, marketing would be custodian of the “service” function: the various

youth/community development programs offered. If this marketing function is designed to include the functions currently performed by the Public Information Office, performance communications would include both crime fighting statistics and community/youth development information: e.g., state of youth development programs, community-police teams, etc. Recipients of this information would be both external (e.g., City leadership, general public, community partners, other stakeholders) and internal (e.g., police command, officers, and staffers) partners. This more respectful, marketing-oriented approach (as opposed to public relations) to policing, and swift and wide communication of “good news” - including crime fighting successes, will help scale back the negative perceptions of the police, ameliorate community tension and apprehension, and create a more positive investment environment in East Fort Myers.

In the long term, crime abatement will depend on revitalization efforts that provide upgraded employment opportunities, helps build pride in and a sense of community identity, promote both sensitivity to the diverse socio-culture of the community, and a heightened focus on area youths to better channel youthful enthusiasm to educational, developmental and recreational activities.

5. Employ a “quality of life” focus in East Fort Myers development with emphasis on recreation, fitness, youths, health, and cultural enhancement. Examples include:

- a. Recreation, parks and green spaces, quality education, child-welfare, culture, and activities that promote wellness and physical fitness.
- b. Youth Centers in partnership with Boys and Girls Club and other community Partners.
- c. Walking, jogging, biking trails along Billy’s Creek and along the Caloosahatchee River.
- d. Accessible sports activities: soccer, basketball, etc..
- e. Passive parks and green spaces. Used consolidated lands provided by: a) Tax Increment Financing (TIF) supported acquisition, b) demolition of boarded up, and abandoned homes, and c) railroad green spaces.
- f. Riverfront parks and river-based recreational activities.
- g. Cultural/civic center.

East Fort Myers contains a large inventory of empty lots and properties that are ready for redevelopment. While some investors and residents may be discouraged by blight and crime in recent years, such properties provide a rare opportunity not only to expand parks but also to build new infill that contributes

to the safety and economic vitality of the neighborhoods. Making neighborhoods more complete by filling in the gaps and improving social and physical conditions will strengthen the neighborhoods and increase community pride and identity. While many quality-of-life activities require public investment, they would serve as engines for private sector investment, identify East Fort Myers as a recreation destination, and be an adjunct economic engine, which would provide clean employment to the area, and great addresses for residents.

- 6. Capitalize on the vibrant economic and entrepreneurial potential so evident in East Fort Myers, by providing access to appropriate zoning and bridging resources; e.g., loan facility and support for small and medium-sized businesses.** Examples include:
- a. Appropriate Zoning; including; used auto retail, and manufacturing.
 - b. Promote new business development; e.g., incentives provided by being in the Lee County Enterprise Zone, structured in centives/loans (TIF funded) to support development of small-medium sized businesses, etc.
 - c. Provide support for small business activities; e.g., South west Florida Enterprise Center, FGCU Small Business development Center, Lee School District: Hi-Tech Center, etc.

One business start-up idea for consideration in East Fort Myers involves systems such as manufacture and installation of roof top solar systems, and installation of both solar water heaters, and solar pool heaters. The current and potentially high future cost of energy, abundant federal and state incentives, relatively low-cost technology for start-up make this is ideal time for the City of Fort Myers to piggy-back on national and statewide efforts to invest in energy transformation.

Currently, there is strong federal and state support for this type of technology. For example, beginning January 1, 2009, residents will be able to claim a 30% federal tax credit on the complete cost roof-top solar installations. Thus, a \$50,000 system would yield \$15,000 tax credits.

According to a recent *News-Press* article (see “Sunshine State Sees Light With Solar,” *News-Press*, October 20, 2008, A1 and A3):

“In Florida, homeowners who install solar panels for electricity also earn rebates at \$4.00 per watt up to \$20,000, provided their photovoltaic system is larger than 2 kilowatts. Those installing solar water heaters and solar pool

heaters can earn rebates of \$500 and \$100 respectively. Florida began its rebate program on July 1, 2006, and solar incentives will sunset on June 20, 2010, unless lawmakers vote to extend that law.

Additionally, all Florida homeowners who install a “renewable energy source device” after January 1, 2009, will be eligible for a property tax exemption in the full amount of their system. This includes solar electric, geothermal, solar water heaters and wind driven generators.

Cobbled together, the new package of incentives makes solar power financially feasible.”

Efforts to introduce these technologies would find strong support from the leadership of the Enterprise Center, as well as the Small Business development Center of Florida Gulf Coast University.

- d. Encourage creation of an area business council to encourage planning, guide development, lobby, provide business representation, and facilitate education and training to the business community.

While infrastructure development is the purview of government, the business community is expected to play a critical role in plan implementation. A critical first step in guiding business will be development of a Strategic Business Plan for the area. Such a plan could be jointly developed by the City and an area business council, and should reflect the proposed East Fort Myers community identity as approved by the Fort Myers City Council, the recommendations of this report, as well as the collected wisdom of business, education/training and professional leaders. The Plan should be specific with respect to type of business/commercial activities, identify possible funding sources, lay-out short, middle and long term objectives, and serve as a guide both to under resourced local entrepreneurs and other businesses.

The proposed revitalization process will facilitate East Fort Myers evolving into a community characterized by broad-based sustained economic and social stability. The envisioned community will offer enhanced public safety where residents become an extension of public security, and generate appropriate economic opportunities, well-paying jobs, and a higher tax base for the City of Fort Myers. The process will help East Fort Myers break its dependence on real estate, build-

ing and housing development, refocus its economics and quality of life around leisure and recreation-based activities, and allow it to evolve into a community where people will want to live, work, and play.

By helping to unleash the tremendous economic and entrepreneurial potential of the community, revitalization efforts would provide employment opportunities, jobs, quality retail opportunities, great residential accommodations, etc. for both residents and increasingly, visitors to the community.

Harnessing the Florida Sun for our Building Systems



Solar Panels. These panels use battery cells to convert solar energy into electricity. This conversion occurs without moving parts, is silent and pollution free in its operation.



Solar Water Heater. These systems do not convert solar energy into electricity, but rather use the sun's rays to heat water.



Solar Tubes channel sunlight into window-less rooms, to reduce the need for electric lighting.

EAST FORT MYERS DEMOGRAPHIC ANALYSIS

Population

As shown in Table 3.10, for the first 7 years of this decade, the population growth of the East Fort Myers study area lagged that of both Lee County and the City of Fort Myers. East Fort Myers grew by 13.1%, while Fort Myers and Lee County grew by 40.7% and 39.7% respectively. During this period, absolute East Fort Myers population grew from 6413 to 7252.

Based strictly on trend forecasting, and using data from traditional demographic sources, the area is projected to grow another 19.0% (7,252 to 8,631) between 2007 and 2012. This rosy forecast does not logically flow from current statistical estimates published by the Bureau of Economic and Business Research - University of Florida, and should be seen as the upper limit on growth.

Table 3.9 shows the annual changes in population growth between 2000 and 2008.

	Years							
	00-01	01-02	02-03	03-04	04-05	05-06	06-07	07-08
Lee County	3.18	4.13	4.21	5.28	5.41	6.58	5.15	1.30
Fort Myers	3.53	2.83	2.35	9.63 ²	6.65	7.03	3.23	1.24
Percent Change in Rate of growth 2000-2008								
Lee County	-	0.39	(0.05)	0.25	0.02	0.22	(0.22)	(0.75)
Fort Myers	-	(0.20)	(0.17)	311.06	(0.31)	0.06	(0.54)	(0.62)

¹ University of Florida, Lee County Department of Community Development, City of Fort Myers, Community Development Dept.- GIS (November-December 2008)

² The significant 2003-04 population increase is largely due to annexation by the City of Fort Myers.

A review of the Lee County demographic statistics reveal that the population, which grew relatively steadily between 2000 and 2006, experienced decelerating growth in 06-07 and 07-08. The population growth statistics for the City of Fort Myers reflected some instability. The large 2003-04 population bump, and resultant percent increase is largely due to residential annexations. In any event, the same pattern of decelerating growth was experienced in 06-07 and 07-08.

Statistically valid data including estimates are currently unavailable for East Fort Myers. Nevertheless, anecdotal observations about the large outward mobility of construction-based/working class residents in search of jobs, high vacancy rates in rental properties, high foreclosure rates, and a surge of blight related code enforcement activity, suggest a decrease in East Fort Myers population. At the very best, the deceleration in population growth in East Fort Myers is estimated as congruent with Lee County and City of Fort Myers.

According to most economic experts, the national home-ownership-financing situation manifested by high levels of foreclosures and almost seismic effect in the real estate, banking and finance industries will place a damper on near term county, city and community population growth. Area population changes will reflect historically low levels of in-migration. Based on these macro-economic realities, as well as the population deceleration rates referenced in Table 3.9, we estimate East Fort Myers population to remain relatively stable in the near future, with annual growth of the order of 0-1%.

Diversity

The East Fort Myers study area is the most racial/ethnic diverse community in Lee County. As shown in Table 3.10, in 2000, the major components of population distribution by race and ethnicity in Lee County were Blacks/African Americans – 6.6%, Whites/Caucasians – 85.3%, and Hispanics/Latino’s – 15.7%. Equivalent statistics for the City of Fort Myers were 33.4%, 56.4% and 14.5%, and East Fort Myers was 29.5%, 49.1%, and 34.3%.

For 2007, the estimated racial/ethnic distribution in the study area was Blacks/African-Americans - 33.6%, Whites - 42.1% and Hispanics/Latino’s – 39.9%. While the rapid racial/ethnic growth is expected to slow somewhat, the projected 2012 distribution is Blacks/African-Americans – 34.7%, Whites – 39.9% and Hispanics/Latino’s – 41.8%.

Other Demographic Measures

Other demographics that define the area and differentiates it from Lee County and the City of Fort Myers includes household size, median age, household income, poverty level, unemployment rate, home ownership and education (Table 3.10). In 2000:

- Persons per household were 2.34 for Lee County versus 2.4 for the City of Fort Myers and 2.9 for the study area.
- Median age was 45.2 years for Lee County versus 32.4 years for the City of Fort Myers and 29 years for the study area
- Average household income was \$56,642 for Lee County versus \$41,649 for the City of Fort Myers and \$34,402 for the study area.
- The percent of the population with income below the poverty level in Lee County was 9.7% compared to 21.8% for the City of Fort Myers and 29% for the target area.
- The unemployment rate was 3.7% for Lee County versus 6% for the City of Fort Myers and 7.6% for the study area. The estimated area unemployment rate was 8.8% for 2007 and anecdotal comments, including relocation of many previously employed in the deteriorated construction industry as a result of the downturn in the housing market suggests a much higher current unemployment rate.
- Renter occupied household was 18.1% for Lee County versus 60.3% for the City of Fort Myers and 45.5% for the study area, and vacancy rates were 23.1% for Lee County versus 12.5% for the City of Fort Myers and 15.6% for the study area.
- Education enrollment at the K-12 level was 16.7% for Lee County versus 23.2% for the City of Fort Myers. Demographics statistics are unavailable but the demographics of the community suggest a higher level of enrollment for the study area. At the upper end of the education spectrum, people with “Some college” to “Graduate education” was 49.7% for Lee County versus 45% for the City of Fort Myers and 38% for the study area.

In general, the demographic portraits of Lee County and the City of Fort Myers are substantially more favorable than the East Fort Myers study area. The projected statistics show continued widening of the gap, paint a picture of community deterioration and decay, and speak to an urgent need for rebirth and revitalization.

The demographic portrait combined with the survey the research findings of this revitalization plan, and recent City staff report, *Home Foreclosure Prevention and Assistance Program*, support the conclusions of another City sponsored study (*East Fort Myers Blight Study*) that the target area is a blighted community.

Based on this demographic assessment, the consumer survey research, and discussion with area stakeholders, East Fort Myers based on its location as a gateway to the City of Fort Myers, the unique River-to-Creek identity and its implication for “quality-of-life” based development, population/cultural diversity, access to I-75, and relatively low-cost real estate, is a candidate for sustained development given the right public policy initiatives, and resource allocation.

Table 3.10: Comparative Demographic Statistics: Lee County, City of Fort Myers and East Fort Myers ¹																		
	Lee County						Fort Myers						East Fort Myers					
	2000		2007		2012		2000		2007		2012		2000		2007		2012	
	#	%	#	%	#	%	#	%	#	%	#	%	#	\$	#	%	#	%
Population																		
Total Population	440,888	--	545,968	23.8	831,457	52.3	48,208	--	67,851	40.7	77,353	14.0	6,413	--	7,252	13.1	8,631	19.0
Male	215,504	48.9	289,771	49.5	404,458	48.6	23,806	49.4	33,481	49.3	38,003	49.1	3,367	52.5	3,806	52.4	4,536	52.5
Female	225,384	51.1	296,197	50.6	426,999	51.4	24,402	50.6	34,370	50.6	39,350	50.8	3,046	3,446	47.5	47.5	4,095	47.4
Race/Ethnicity																		
Black	29,035	6.6	42,773	7.3	51,581	7.6	16,095	33.4	18,286	34.1	18,170	31.6	1,894	29.5	2,438	33.6	3,001	34.7
White	286,598	87.7	499,968	85.3	572,516	84.3	27,166	56.4	28,855	53.8	32,344	56.2	3,155	49.1	3,047	42.1	3,447	39.9
Hispanic	42,042	9.5	91,921	15.7	124,342	18.3	6,984	14.5	11,681	21.8	13,918	24.2	2,206	34.3	2,896	39.9	3,609	41.8
Households																		
Total Households	188,599	--	252,539	33.9	292,968	16.0	19,104	--	21,931	14.8	23,768	10.8	2,199	--	2,501	13.7	2,975	19.0
Persons per Household	2.34	--	2.31	--	2.30	--	2.40	--	2.34	--	2.33	--	2.9	--	2.9	--	2.9	--
Age Distribution																		
0 - 4 years	22,970	5.2	33,080	5.7	37,698	5.6	3,927	8.2	4,209	7.9	4,352	7.6	599	9.3	676	9.3	796	9.2
5 - 19 years	71,759	16.3	98,875	16.9	117,053	17.3	10,212	21.2	10,884	20.3	11,788	20.5	1,550	24.1	1,624	22.3	1,859	21.5
20-64 years	279,257	53.3	320,676	44.7	370,834	54.5	27,332	56.6	30,577	56.9	32,484	56.5	3,971	59.1	4,167	57.5	4,981	57.7
Over 64 years	112,111	25.4	133,315	22.8	153,387	22.6	6,721	13.9	7,984	14.9	8,945	15.5	662	10.3	782	10.7	994	11.5
Median Age	45.2	--	43.3	--	43.3	--	32.4	--	31.9	--	32.3	--	29	--	32	--	34	--
Household Income																		
Average household income (\$)	56,624	--	68,665	21.2	78,359	14.1	41,649	--	48,646	16.8	54,560	12.2	34,402	--	40,010	16.3	45,748	14.3
% of population with income below poverty	--	9.7	--	10.6	--	11.4	--	21.8	--	22.3	--	29	--	29	--	29	--	29

Table 3.10: Comparative Demographic Statistics: Lee County, City of Fort Myers and East Fort Myers ¹																			
Labor Force																			
In Labor Force	193,893	--	277,379	57.7	321,388	57.8	22,071	--	25,735	16.6	27,524	7.0	2,858	--	3,234	13.2	3,761	16.4	
Employed	184,499	96.2	261,904	94.4	303,433	94.4	20,749	94.0	23,553	91.5	25,128	91.3	2,639	92.3	2,954	91.3	3,486	92.6	
Unemployed	7,232	3.7	15,282	5.5	17,726	5.5	1,317	6.0	1,317	6.0	2,177	8.5	218	7.6	285	8.8	275	7.3	
Not in Labor Force	169,927	46.7	202,797	42.2	234,196	42.1	14,667	39.9	15,941	38.3	17,343	38.7	1,831	6.4	376	8.6	5.5	7.3	
Housing Occupancy																			
Total Housing Units	245,405	100	338,621	100.0	397,976	100.0	21,838	100.0	25,817	100.0	28,422	100.0	2,613	100.0	3,006	100.0	3,559	100.0	
Owner Occupied	144,245	58.8	182,447	53.9	206,773	52.0	7,593	39.7	7,972	30.9	8,338	29.3	1,010	38.6	1,202	39.9	1,372	38.5	
Renter Occupied	44,354	18.1	70,092	20.7	86,195	21.7	11,514	60.3	13,958	54.1	15,430	54.3	1,189	45.5	1,299	43.2	1,603	45.0	
Vacant	56,806	23.1	86,082	25.4	105,008	24.4	2,729	12.5	3,886	15.1	4,654	16.4	414	15.6	506	16.8	584	16.4	
Education																			
Grades K - 12	54,733	16.7	55,875	13.2	51,563	10.6	8,192	23.2	7,279	21.9	6,252	17.6	1,562	40.9	1,317	32.9	1,090	26.4	
HS Graduate	106,480	32.5	142,075	33.7	166,937	34.4	8,769	24.8	10,445	31.4	11,668	32.8	1,080	55.7	1,311	32.8	1,437	34.7	
Some College, No Degree	74,119	22.6	90,295	21.4	99,305	20.5	5,446	15.3	6,067	18.3	6,401	18.0	511	26.3	621	15.5	661	16.0	
College Graduate	88,790	27.1	133,496	31.7	167,821	34.6	6,997	19.7	9,434	28.4	11,302	31.8	227	11.7	752	18.8	949	23.0	
No Schooling Complete	3,221	1.0	No data	No data	No data	No data	601	1.7	No data	No data	No data	No data	124	6.4	No data	No data	No data	No data	

¹ US Census, University of Florida, Lee County Department of Community Development, and City of Fort Myers, Community Development Dept.- GIS (August-September 2008)

PALM BEACH BOULEVARD CORRIDOR BUSINESS PROFILE

The Palm Beach Boulevard Corridor has many dedicated business-owners. Despite their efforts, they have been challenged by unsympathetic changes to the roadway. Some business owners, however, have neglected their properties. A few extreme cases show a state of complete abandonment. Changing the character of this corridor is essential not only in order to improve the image of the study area, but also to form an attractive gateway to the City of Fort Myers.

As shown on Table 3.11, the target area contains 182 public-private sector organizations, located mostly along the Palm Beach Boulevard corridor, from Billy's Creek to the vicinity of Prospect Avenue. In reality, the shopping district extends eastward along Palm Beach Boulevard to I-75 and beyond (Lee County). The County part of Palm Beach Boulevard, between Prospect Avenue and I-75 is similar in character to the City part, and include businesses such as: US Post Office, Publix Supermarket, Sonny's Barbeque, Roller Skate Rink, North Trail RV Center, and various gas stations and fast food restaurants.

The data is organized into twenty-six categories, from Accommodations to Miscellaneous. The largest category of firms/organizations is Automotive Sales, Supplies and Services (19.8%). Other major categories are: Restaurants (13.2%), Personal Grooming Services (7.7%), Financial Services (5.5%), and Religious/Churches (4.4%), Bars and Night Clubs (4.4%).

Mix and Type of Organizations

The mix and type of organizations is not uncommon for a community with the socio-cultural-economic mix that characterizes East Fort Myers. For example, guest accommodations are low-cost motels instead of the national brand hotels that survey respondents would like to see located in the community. Perhaps the only uniqueness are Financial Services, where 8 of the 10 organizations; 80%, are money transfer firms, mostly to Latin American countries; Mexico, Honduras, etc, and restaurants where the name suggests 52 % are ethnic. This is consistent both with the high Latino concentration of immigrants and the high Hispanic population (40%) in the area.

Note the absence of bookstores, cinema/movie houses, etc. These are business activities that survey respondents expressed interest in having located in the community. Unfortunately, the current socio-cultural-economic environment is unlikely to support such activities as the area lacks the critical mass of retail and entertainment activities needed to attract persons from outside the area.

In general, the businesses are small, private, and community owned. Indeed, except for nationally branded fast foods; e.g., McDonald's and Wendy's, and banks such as Bank of America and Wachovia, the preponderance of the firms are locally owned.

The last column to the right on Table 3.11 compares Dr. Martin Luther King Jr./Veronica S. Shoemaker Boulevards, in Dunbar, to Palm Beach Boulevard, in East Fort Myers. The comparison was attempted since both are, (1) Gateway corridors to the City of Fort Myers, and (2) bisect low income, blighted, ascendant communities. A brief comparison of the profile of organizations along both corridors indicates significant differences. Dunbar has manufacturing-industrial focus while East Fort Myers has a retail focus. The reason for the differences is not clear, though one may speculate that it mirrors both the cultural-ethnic differences and historical land use patterns.

Table 3.11: Organizations along the Palm Beach Boulevard Corridor (Billy's Creek to Prospect Avenue)

Type of Organizations	Palm Beach Boulevard		Dr. Martin Luther King Jr. /Veronica S.Shoemaker Corridor Percentage (%)
	Number (#)	Percentage (%)	
Accomodations	6	3.3%	0%
1. Come Back Inn			
2. Highlander Motel			
3. Oasis Condominiums			
4. Palm Beach Landing			
5. Palm Pine Park (Mobile homes)			
6. Rock Lake Resort			
Automotive Sales	36	19.8%	8.7%
1. Action Motors			
2. Anytime Auto Sales			
3. Auto Zone			
4. Autorama Auto Sales			
5. Brazil Auto Sales			
6. Care Free Auto Sales			
7. Car R-Us Sales			
8. Cherry Cars (sales)			
9. City of Palms Auto Sales			
10. D E Foeller Auto Sales			
11. East Side Motors			
12. Friends and Family Motors			
13. Friday's Auto Sales			
14. J L Auto Sales			
15. Land Auto Supply			
16. Mr. Chip's Auto Sales			
17. Palm Beach Used Cars			
18. PSI Auto			
19. Preferred Auto Sales			
20. Precision Automotive			
21. Ponce Used Car Sales			
22. Universal Auto Sales			
23. World Auto Wholesale			
Automotive Supplies and Services			
24. AAA Axles			

Table 3.11: Organizations along the Palm Beach Boulevard Corridor (Billy's Creek to Prospect Avenue)

25. Advance Auto Parts			
26. Auto Credit			
27. Beckman's Service/Complete Auto Repairs			
28. Dixie Choppers Stihl Auto Parts			
29. Happy Days Car Wash			
30. Leal's Tires and Wheels			
31. McAllister's Auto Electric			
32. McAllister's Auto Repair			
33. Mr. Auto Insurance			
34. Pelican Service and Collision Center			
35. Right Way Transmission			
36. X-Press Auto Parts			
Bars and Night Clubs	8	4.4%	0.9%
1. Club 809 Night Club			
2. Come Back Inn			
3. Coyote Night Club			
4. El Chubasco Restaurant Bar and Night Club			
5. Las Duenas Lounge			
6. Liquor Land			
7. Red Bones Salon			
8. Rio Grande Night Club			
Clothing/Fashion	6	3.3%	2.6%
1. American Eagle			
2. Army & Navy Store			
3. Badavi Fashions			
4. D & D Fashions			
5. Payless Shoe Store			
6. Up-Time Men's Fashion			
Consumer Electronics	4	2.2%	0.9%
1. EMBARQ Relay Site			
2. Metro PCS Dealer			
3. Metro PCS Dealer			
4. Mundo Hispano Corporation (communications equipment)			

Table 3.11: Organizations along the Palm Beach Boulevard Corridor (Billy's Creek to Prospect Avenue)

Convenience Stores/Supermarkets	5	2.7%	10.4%
1. Groceries, Beverages & Deli Store			
2. Kwik Stop Food Store			
3. Price Busters Food Center			
4. Pueblo Food Center (convenience store)			
5. U-Save Supermarket			
Discount Retail	3	1.6%	0.9%
1. Family Dollar			
2. Goodwill Life Academy			
3. Nation's Association Thrift Store			
Education/Training/Child Care	3	1.6%	5.0%
1. Edgewood Academy			
2. Goodwill Life Academy			
3. Lee County Economic Development Corporation (LEEDCO)			
Financial Services	10	5.5%	0.9%
Banks	2	20%	
1. Bank of America			
2. Wachovia Bank			
Check Cashing/Money Transfer	8	80%	
1. Circulo Maya Express Money Transfer			
2. Dolex Dollar Express Money Transfer			
3. Envios de Dinero			
4. Fast Pay Day Loans			
5. LA #1 Money Transfer			
6. La Onda Latina Money Transfer			
7. Maya Express Circula Maya Money Transfer			
8. Pay Day Advance (check cashing)			
Floral Arrangements/Garden/Landscape Center	3	1.6%	2.6%
1. Albin Landscape			
2. Full Circle Floral Design			
3. Scrivner's Garden Center			

Table 3.11: Organizations along the Palm Beach Boulevard Corridor (Billy's Creek to Prospect Avenue)

Home and Office Furnishings	4	2.2%	0.9%
1. Buddy's Home Furnishing			
2. Budget Office Furniture			
3. Gully's Discount Store Fixtures			
4. Taylor Carpet One			
Income Tax Preparation	2	1.1%	0%
1. Liberty Tax Service			
2. Tax Latino Corporation			
Insurance	4	2.2%	0.9%
1. Atlantica Southeast Insurance			
2. Edison Insurance			
3. Humphrey and Whidden Insurance			
4. Stetson Insurance			
Jewelry & Pawn Shops	2	1.1%	0.9%
1. A&A Jewelry Store			
2. Jewelry/Pawn Shop			
Laundry & Dry Cleaning	4	2.2%	0%
1. Classic Cleaners			
2. Coin Laundromat			
3. Palmetto Wash House			
4. Wash Bowl Coin Laundry			
Marine Sales & Supplies	2	1.1%	0%
1. Marine Surplus			
2. San Carlos Marine Sales			
Parks and Recreation	2	1.1%	1.7%
1. Riverside Park			
2. Terry Park Facilities			
Personal Grooming Services	14	7.7%	8.7%
1. Alex Beauty Salon			
2. Badawi Hair and Beauty Supply			
3. Barber Shop			

Table 3.11: Organizations along the Palm Beach Boulevard Corridor (Billy's Creek to Prospect Avenue)

4. Barber Shop			
5. China Nails			
6. Chispas Hair Salon			
7. D'Classico Beauty Salon			
8. Hair Care			
9. Hair Magic Beauty Salon			
10. Maxeen's Hair Design			
11. Nail's USA			
12. Sarah's Beauty Supply			
13. Stephanie's Hair Care Salon			
14. Virgaleen's Hair Magic Care			
Peronnel/Labor Staffing	2	1.1%	0%
1. Balance Staffing Service (Day Labor)			
2. Labor Finder			
Petroleum/Service Stations	5	2.7%	3.5%
1. BP Gas Station			
2. Citgo Gas			
3. Hess Gas Station			
4. Hess Gas Station			
5. Pure Gas Station			
Pharmacueticals/Health/Medical Services	6	3.3%	1.7%
1. Family Health Center of Florida			
2. Nicaso M. David, MD.			
3. Palm Beach Medical Center			
4. Rudolpho Saludo, MD.			
5. Small Animal Hospital			
6. Walgreen's Pharmacy			
Real Estate Sales	1	0.5%	0%
1. ERA Falcone Realty Group			
Religious/Churches	8	4.4%	15.7%
1. Chapel of Our Lady Queen of Angels Traditional Roman Catholic Church			
2. Church of God Prophecy			
3. Covenant Community Ministries			

Table 3.11: Organizations along the Palm Beach Boulevard Corridor (Billy's Creek to Prospect Avenue)

4. East Fort Myers Church of Christ			
5. Edgewood United Methodist Church			
6. Iglesia de Dios (Church of God)			
7. Iglesia Pentecostal			
8. Iglesia Pentecostal Peniel, Inc.			
Restaurants	24	13.2%	6.1%
Chain	6	28%	
1. Burger King Restaurant			
2. Kentucky Fried Chicken Restaurant			
3. McDonald's Restaurant			
4. Popeye's Chicken Restaurant			
5. Subway Sandwiches			
6. Wendy's Restaurant			
Traditional	5	20%	
1. Evans Neighborhood Restaurant			
2. Eris Restaurant			
3. Ice Cream			
4. Red Bones BBQ			
5. Route 80 Restaurant			
Ethnic	13	52%	
1. Baby Mariachi Loco Restaurant			
2. Cafeteria El Caribe Restaurant			
3. China Buffet Restaurant			
4. Chinese Kitchen Restaurant			
5. Don Carlos Mexican Restaurant			
6. Fortune Cookie Chinese Fast Food			
7. Juanita's Mexican Food			
8. La Comida de Cecelia			
9. Mi Casa Restaurant			
10. Restaurante Juanita's Mexican Foods			
11. Taco Express Restaurant			
12. Tropical Latino Restaurant			
Social & Food Bank Services	2	1.0%	4.3%
1. Homeownership Resource Center			
2. McGregor's Baptist Food Pantry			

Table 3.11: Organizations along the Palm Beach Boulevard Corridor (Billy's Creek to Prospect Avenue)			
Miscellaneous	16	8.8%	23.5%
1. Anderson Funeral Home			
2. Autobus			
3. Botanica el Sol - Spiritualist			
4. Connie's Place - Ceramics			
5. Creel Tractor Company			
6. Crystal Springs Water			
7. Fort Myers Broadcasting Company			
8. Fiesta Deportes Soccer Supply - Sports Retail Store			
9. Futural's Feed Store			
10. Hood Machine Shop			
11. Lloyd's Luggage			
12. Reilly Brothers - Plumbing, Electrical, Hardware (closed)			
13. Romano Brothers Rentals/sales/service (closed)			
14. Southern Comfort - Heating and Air Conditioning			
15. Southwest Florida - Printing (closed)			
16. TV Center Sales & Service			
Total	182	100%	100%

This data was collected by Lee R. Duffus from a walk-by census, August-October 2008.



four-point strategy 4

THE FOUR-POINT STRATEGY

Through the charrette process, the community and design team arrived at a series of action steps to guide the redevelopment of East Fort Myers. The *Four-point Strategy* highlights the essential elements necessary for transforming the area. The initiatives proposed address the need to improve the social, environmental, and economic fabric of East Fort Myers. The points embody a shared vision and provide guidance to the residents, business owners, and public officials who will be implementing the plan. The Four-point Strategy will require a lot of hard work and cooperation amongst residents, the City of Fort Myers, and all those that have a stake in East Fort Myers. Yet, the community already has attributes that should make it the envy of other communities: waterways and access to the Gulf of Mexico, historic buildings that are both instructive and a source of pride, a central location, and residents and stakeholders who care deeply about its future.

The first point, “City of Neighborhoods” describes the need to reclaim the neighborhood unit as the basis for planning in East Fort Myers. Years of car use and automobile-oriented development have blurred the neighborhoods' natural and man-made barriers and eroded the neighborhood fabric. East Fort Myers has many residents who are unable or do not wish to own and operate a vehicle. The neighborhood unit must be reintroduced here so that each neighborhood may satisfy most or all of its residents' daily needs within walking distance.

The second point, “Build More – But Make it Good,” discusses how certain areas are appropriate for more intense development than what is currently zoned/regulated. Yet, in order for such increased development to add convenience to peoples' lives while adding value to the community, it must be diverse, mixed-use, and shape high-quality public and private spaces.

The third point, “Transform the Boulevard” addresses the need to redesign Palm Beach Boulevard so that it can once again become convenient for all of its users, not just those using it to access downtown Fort Myers from I-75. Technical aspects of Palm Beach Boulevard's transformation are discussed in greater detail in Chapter 5: Transportation.

The fourth point, “Connect the Green Spaces” offers a strategy for creating a green network that is useful both for human recreation and natural habitat. A well connected green network, which includes a range of open spaces such as wilderness, parks, plazas, streets, and food gardens, is essential to the health of East Fort Myers.

FOUR-POINT STRATEGY FOR EAST FORT MYERS



CITY OF NEIGHBORHOODS

Create compact, complete, sustainable neighborhoods, anchored by new mixed-use centers.



BUILD MORE – BUT MAKE IT GOOD

Grow an intense mix of uses and more diverse, high-quality, housing types.



TRANSFORM THE BOULEVARD

Make Palm Beach Boulevard work for businesses and pedestrians.



CONNECT THE GREEN SPACES

Assemble a better green network and enhance connections to the Caloosahatchee River and Billy's Creek.



Figure 4.1: The Illustrative Master Plan (see page 4.4 - 4.5 for more detail)

The master plan for East Fort Myers organizes the study area into neighborhoods. While it is difficult to include every service and activity in every single neighborhood, the intent of this report is to set out a strategy to make each neighborhood as complete as possible. This will entail looking for imbalances and restoring them. For instance, there may be a deficit of convenience retail, employment centers, schools, or park space in a neighborhood. The master plan looks for ways to physically accommodate the missing elements and then proposes an implementation strategy for achieving the desired balance. This master plan contains many perspective drawings that suggest the desired character and intensity of redevelopment; these drawings are illustrative only and are not self-implementing regulations.

As with any long-term blueprint for the future of a community, the master plan should be thought of as a project which contains action steps to undertake immediately, even though there are enough action steps to keep East Fort Myers and the City of Fort Myers busy for many years to come. This report can be used to check off each action step until all have been implemented.

- A** Intensify the neighborhood near Seaboard Street.
- B** Create a public Riverwalk between Riverside Park and Tarpon Street Pier.
- C** Restore native habitat on both sides of Billy's Creek and add kayak drop-in points.
- D** Link north and south banks of Billy's Creek with a pedestrian bridge that would connect Shady Oaks Park to the city's cemetery property.
- E** Promote the adaptive reuse of historic buildings.
- F** Short term: Remove or reconfigure median barriers in select locations along Palm Beach Boulevard.
- G** Long Term: Lower design speeds at crossroad centers and reconfigure Palm Beach Boulevard as a main street.
- H** Promote infill development that respects the historic scale and character of East Fort Myers.
- I** Locate parking lots and parking structures mid-block or at the rear of buildings.
- J** Reduce on-site parking requirements on oddly-shaped lots or small parcels.



The Illustrative Master Plan synthesizes community ideas and depicts the idealized buildout for East Fort Myers. This final version of this map is not intended to become a regulatory document.



- (K)** Create Seminole Avenue Park with sites for mixed-use buildings facing the park.
- (L)** Connect dead-end streets and restore the street grid.
- (M)** Create a new neighborhood that completes the historic street grid and preserves the natural floodplain along Billy's Creek.
- (N)** Create transit-ready development that anticipates a revived passenger rail and improved bus system.
- (O)** Create a sunset overlook along the river at the end of the vacant right-of-way of Princess Street.
- (P)** Convert strip-shopping centers into town blocks, reintegrating retail into a traditional pattern of blocks and streets.
- (Q)** Redevelop blighted apartment complexes as mixed-income neighborhoods.
- (R)** Work with property owners and city officials to create new neighborhood parks.
- (S)** Add sidewalks and plant shade trees on neighborhood streets.
- (T)** Create community gardens on unused parcels.

Figure 4.2: The Illustrative Master Plan identifies key opportunity parcels for infill development and preservation of open space.

CITY OF NEIGHBORHOODS

create compact, complete, sustainable neighborhoods, anchored by new mixed-use centers

East Fort Myers is a community of diverse neighborhoods along the commercial spine of Palm Beach Boulevard. In order for the area to thrive, each neighborhood needs to be made more complete. The success of one neighborhood relies upon the success of the entire area. Each neighborhood should be thought of as a place in which most residents may satisfy some of their daily needs by foot or by bicycle. East Fort Myers contains an ample inventory of empty lots and properties that are ready for redevelopment. While some investors and residents may be discouraged by creeping blight in recent years, such properties provide a rare opportunity not only to expand parks but also to build in a way that contributes to the safety and economic vitality of the neighborhoods. Making neighborhoods more complete by filling in the gaps and improving social and physical conditions will strengthen the neighborhoods and increase community pride and identity.



Figure 4.4: Van Buren Street Park, existing conditions.



Figure 4.3

Van Buren Street Park

A drainage pond located at the intersection of Van Buren Street and Washington Avenue is not accessible and prevents Van Buren Street from connecting to the neighborhood just to the south. Van Buren Street should be allowed to curve around the pond, which could become the centerpiece to a new neighborhood park. Lots facing the pond could be developed so that homes present their faces rather than their sides toward the park.



Figure 4.5: Van Buren Street Park, proposed. Van Buren Street is reconnected around the pond and new homes front onto this memorable public space.

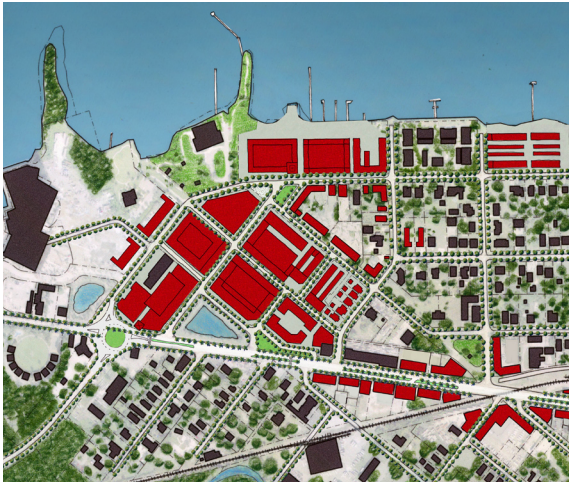

Figure 4.6

East Riverside Drive to Fremont Street

The area near the intersection of Palm Beach Boulevard and Seaboard Street contains a diverse mix of housing types, from several skyscraper condominiums (The Oasis) to historic bungalows and the Palm and Pine Trailer Park. The area lacks a suitable transition from the high-rise scale to the one-story scale of the historic homes. A historic rail station is evidence of the former importance of this part of town.

This area should be developed with an intensity that would be supportive of transit once again, while respecting the need to limit development especially in the portions that lie within the Coastal High Hazard Area.



Figure 4.7

Walkable Centers

- Balance between land uses - places to live, work, shop, entertain, and socialize
- Served by transit
- Access to schools
- Public outdoor spaces



Figure 4.8

BUILD MORE - BUT MAKE IT GOOD

grow an intense mix of uses & more diverse, high-quality housing types

Neighborhoods should contain not just houses, but a mix of uses that are adaptable for change over time. A variety of uses within a neighborhood creates the ability to live, work, shop, and have some daily needs and services within walking distance. Housing for a mix of incomes should continue to be provided in East Fort Myers. A variety of building types allows for a diversity of family sizes, ages, and incomes to live in the same neighborhood. With high-quality development, growth and change can make things better rather than worse. The residents and business owners of East Fort Myers should demand and expect nothing less.

The Illustrative Master Plan identifies specific sites for residential and mixed-use infill development. Opportunities exist within the neighborhoods to grow more complete, adding a mix of uses and more diverse housing types. To the left, the illustration demonstrates one possibility for the redevelopment of the Palm and Pine Trailer Park. In this scenario cottages and townhomes are organized along a connected network of blocks and streets, taking cues from historic settlement patterns in the area.

Recommendations

The planning team recommends that the western portion of East Fort Myers, where Billy's Creek flows into the Caloosahatchee River, not be developed with skyscrapers similar to those recently constructed there. There are many reasons to encourage the development of predominately humanly scaled “walk-up” building types in this area rather than skyscrapers:

1. The most intensely developed parcels in the city should be those located in downtown Fort Myers. If downtown Fort Myers is to remain the economic and social heart of the larger metropolitan region, then building types appropriate for the urban core should be limited in East Fort Myers.
2. While the real estate market may be able to absorb incremental rebuilding of neighborhoods, high-rises further contribute to the softening of the real estate market by creating more units or leasable space than can be absorbed.
3. Low-rise and mid-rise building types are able to accommodate parking with less structured parking than skyscrapers. Exposed parking podiums deaden the streetscape and do not provide natural surveillance that is crucial to maintaining a sense of safety for those walking along the streets. By building fewer and shorter parking garages, the savings gained by not constructing taller garages or

more spaces per unit can be passed on to the purchaser or renter of the unit. Developers elsewhere in Florida have also unbundled parking spaces from the cost of the residential unit, so that residents may opt out of the purchase of some or all of their allotted parking spaces, making the unit more affordable.

4. Modestly sized buildings are usable even in a power outage whereas elevator-dependent building types may become difficult to use and inhabit when there is a storm-related black-out. During the 2005 hurricane season peer communities in South Florida realized that even when generators were available, this did not guarantee usability of the building systems. Disruptions in fuel supply and distribution rendered some generators, and the skyscrapers that depended upon them, uninhabitable during the power outages after the storms.

5. It is not prudent to keep increasing the number of residents whose dwellings are placed in harm's way in low-lying coastal areas. People are naturally attracted to the waterfront, but East Fort Myers has higher ground that can accommodate most new development. The increasing frequency of storm surges and the vulnerability of floodprone properties to sea level rise dictate caution when determining the appropriate height and intensity of development along the Caloosahatchee River.



Figure 4.9: The blocks at the western edge of the study area can be redeveloped as a lively pedestrian-scaled town center.

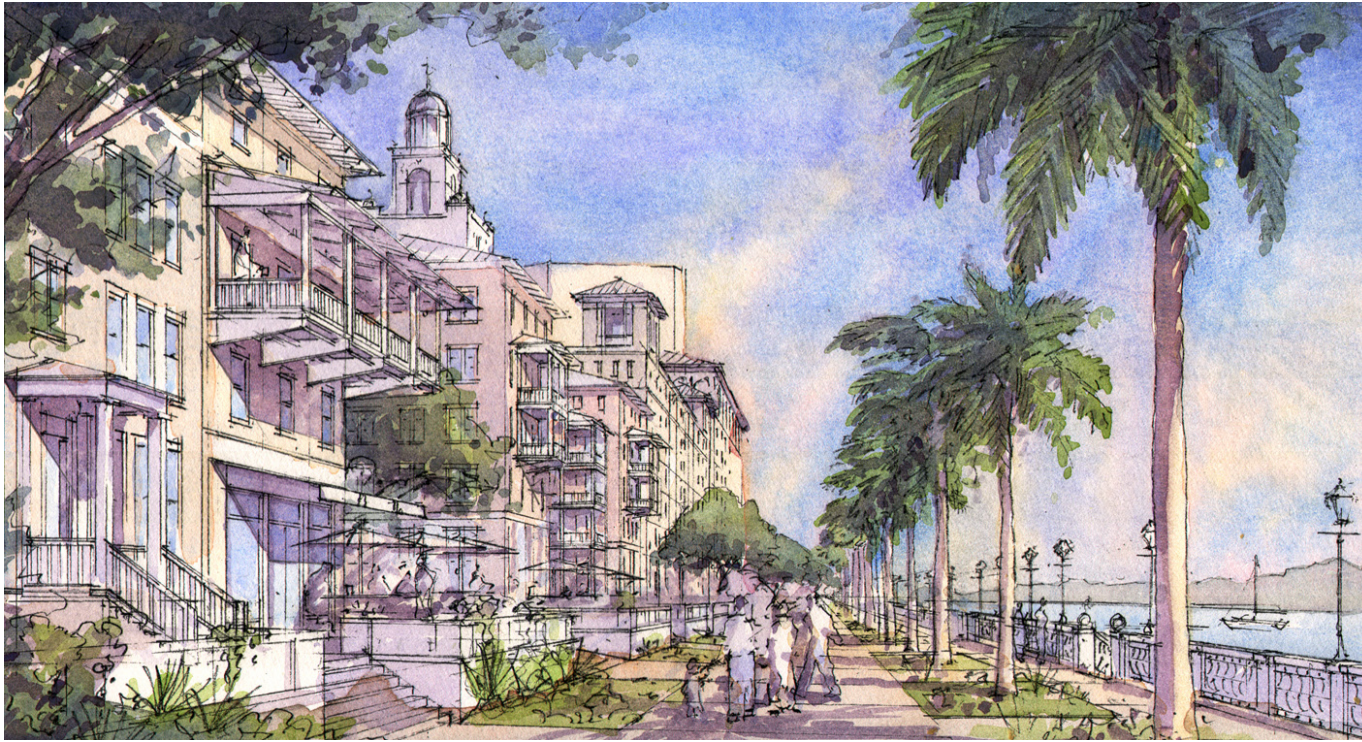

Figure 4.10: The proposed Caloosahatchee Esplanade

There are few points of public access to the Caloosahatchee River. The properties between Riverside Park and the Tarpon Street Pier have a unique opportunity to be redeveloped with a public esplanade. This esplanade would have important public and private benefits and would add value to adjoining properties if they are redeveloped in a manner that takes advantage of this amenity, as shown in the illustration above. Buildings should front the Riverwalk and waterfront dining and retail space should be included. Residential units should take the form of rowhouses and garden apartments. Beyond Tarpon Street Pier, the existing scale of the waterfront properties should be maintained.

New construction will have to be elevated in order to comply with flood zone regulations, but new buildings should not be raised on a base that is exposed or has blank walls. Rather the necessary height difference between the first floor and the esplanade should incorporate landscaped terraces, sitting porches, and stoops. The edge of the esplanade could be detailed with an urban character in some places and a natural character in others. The portions that have an urban character would have a bulkhead, balustrades, and regularly spaced trees reinforcing the line of building facades that face the water. The portions of the esplanade that have a natural character could have a softer edge, with clumps of mangroves and other aquatic plants arranged organically between the walkway and the water's edge.

ACTION STEP # 1 PUBLIC ACCESS ALONG THE RIVER

The Land Development Code now requires developers to donate a ten-foot-wide easement for a Riverwalk from the Royal Palm Yacht Club to Billy's Creek. An additional segment will be constructed as a boardwalk around the Oasis towers. Planning for this Riverwalk should be extended east to the Tarpon Street Pier, with intermediate connections at Superior and Freemont Streets.

- The Comprehensive Plan should be amended to establish general policy for a public Riverwalk all the way from the Edison & Ford Winter Estates to the Tarpon Street Pier.
- The Comprehensive Plan should be modified to allow the Riverwalk extension or public esplanade east of Billy's Creek to replace the standard requirement for an undisturbed native-vegetated buffer along the river.
- The Land Development Code should be amended to provide specific requirements for extending the downtown Riverwalk over time from Billy's Creek east to Tarpon Street.



Figure 4.11: Existing Buildings

The analysis of the figure ground of existing buildings includes a comparison of the study area to many different graphics or GIS layers such as which parcels are publicly owned, an inventory of transit infrastructure, and constraints imposed upon development by natural features. The figure ground map of existing neighborhoods reveals the grain of the urban fabric, where the large open spaces are, where nodes of urban intensity are forming, or should be formed, along with a striking contrast between the Palm Beach Boulevard Corridor and the neighborhoods to the north and south of it.

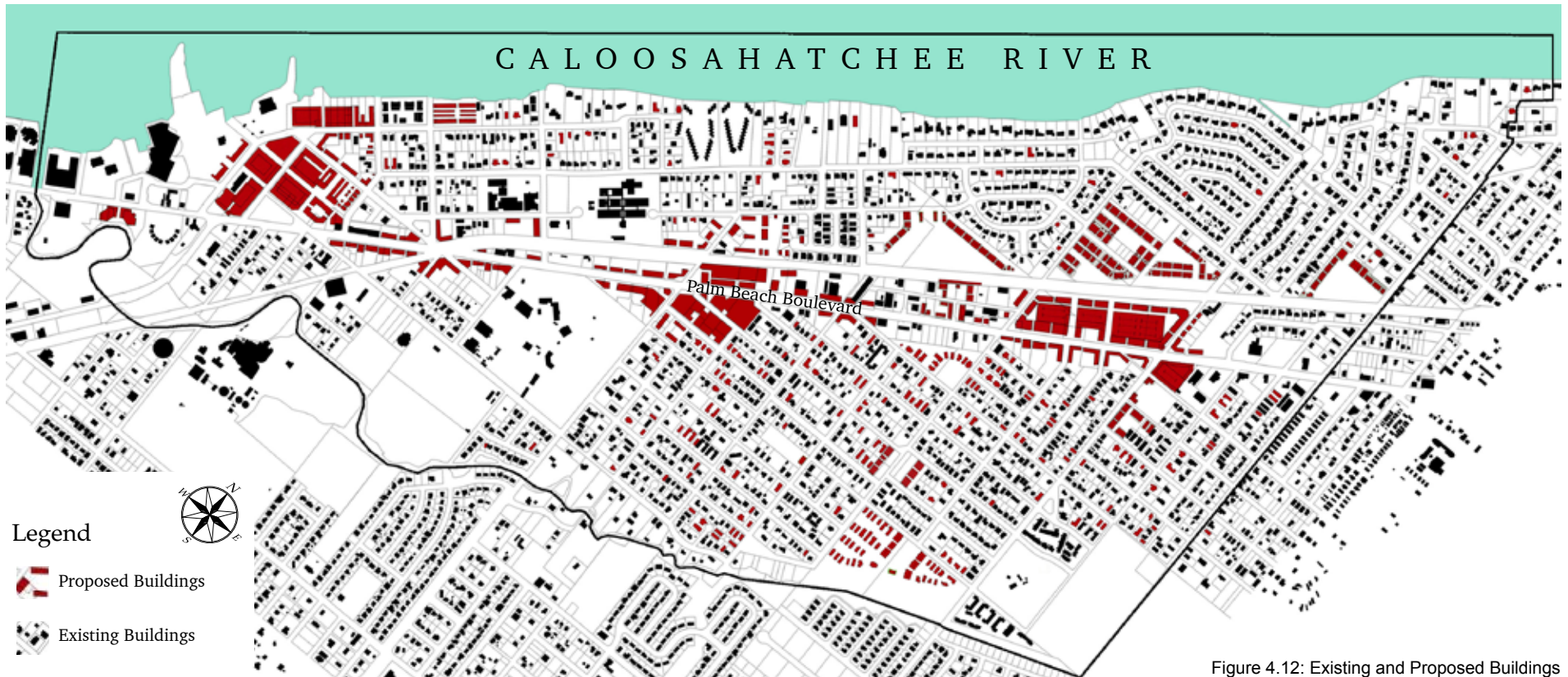

Figure 4.12: Existing and Proposed Buildings

Proposed buildings can be placed in one of two categories: infill or redevelopment. Infill refers to construction on empty lots. Redevelopment involves demolition of non-contributive, obsolete, or unsafe structures and then replacing them with new construction. In a few cases, redevelopment may include the rehabilitation of such structures. The proposed buildings start to make legible public spaces and streets. The proposed buildings plan shows that East Fort Myers can accommodate hundreds of new structures, both large and small, to accommodate many years of growth. This type of urban infill and redevelopment is an essential antidote to sprawl which threatens environmentally sensitive and agricultural lands located to the south and east of the metropolitan area.



Figure 4.13: Proposed site plan



Figure 4.14: Detail of rowhouses with stoops, doors and windows facing the street.

Cypress Courts is an example of an obsolete model for affordable housing. The façade of that faces the street is neither a front nor back, creating confusion and a lack of private outdoor space. The public realm is further degraded by the placement of air conditioning units between the buildings and the street, a barren and sandy planting strip, and flimsy and impermanent materials. Cypress Courts should be redeveloped as attached rowhouses or garden apartment buildings, with front doors facing the street and rear yards or shared patios located at the center of the block. Permanent materials should be used along with abundant landscaping.



Above: Figure 4.15: A block of townhomes provides parking in the rear so that the streets become pedestrian friendly. Image from the *Dr. Martin Luther King Jr. and Veronica S. Shoemaker Boulevards Revitalization Plan*.

Right: Figure 4.16: Existing conditions - Cypress Courts.





Figure 4.17: Proposed site plan



Figure 4.18: Existing conditions

Palm Beach Boulevard at Marsh Avenue

Obsolete shopping centers at major intersections can be reborn as mixed-use centers. The shopping center located along Palm Beach Boulevard between Marsh Avenue and Van Buren Street should eventually be redeveloped with town blocks and as street-oriented mixed-use buildings. This will be possible as this stretch of Palm Beach Boulevard is rebuilt to a lower design speed with on-street parking and a higher degree of pedestrian access. Parking lots or garages should not be located between the businesses and Palm Beach Boulevard, but rather to the rear, and should be lined with habitable space, as shown in the illustration below. New streets and alleyways should be introduced to increase to take traffic pressure off of Palm Beach Boulevard, especially for very short trips. A centralized parking supply would help to create a park-once environment.

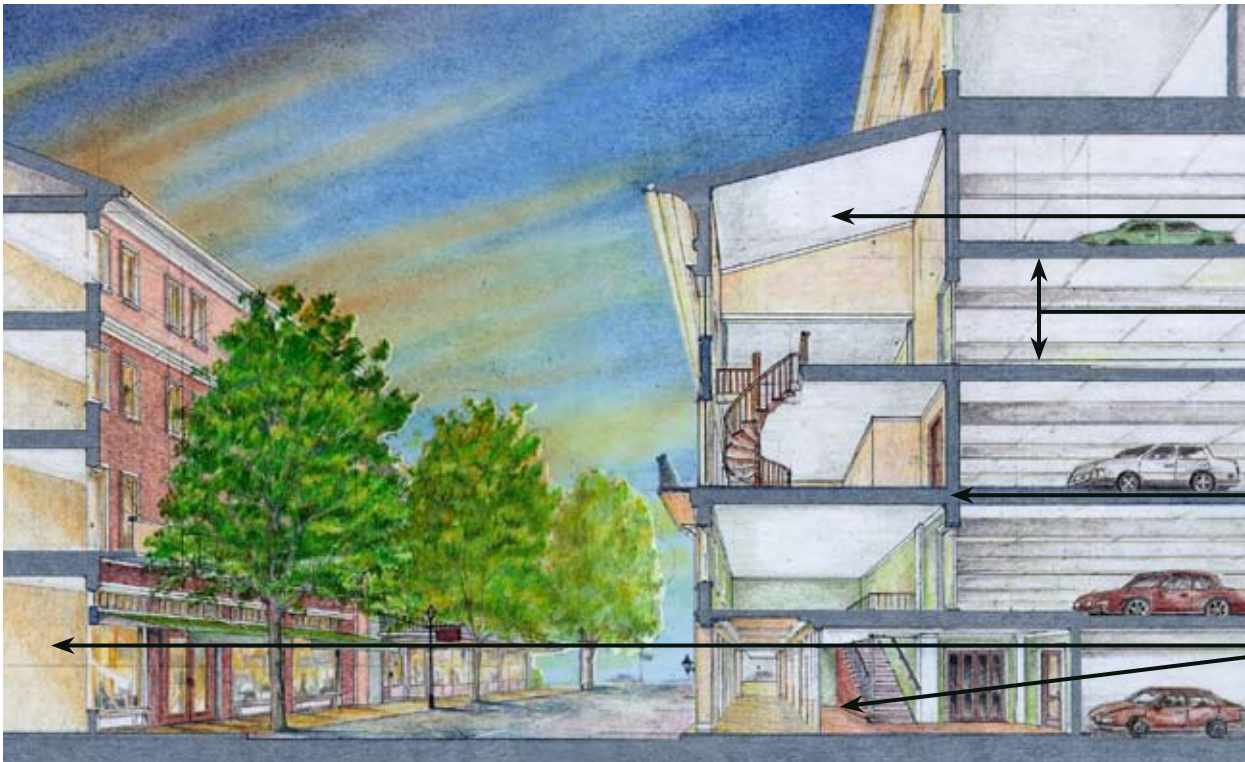

Figure 4.19: Section perspective illustration through garage and liner buildings.

- ← Habitable space (offices or apartments) lines parking structures.
- ↕ Floor to ceiling heights of parking structures allow for future conversion of these to habitable/leasable space.
- ← Floor levels of the parking structure align with floor levels of habitable space.
- ← Lobbies and retail are located at the ground floor.

CHANGE OVER TIME

Palm Beach Boulevard and Marsh Avenue



Existing Conditions. East Fort Myers Shopping Center. Storefronts are set back behind large surface parking lots, which is typical of suburban, drive-to retail. East Fort Myers already has heavy pedestrian traffic, and redevelopment should encourage this behavior.



Step 1. After improvements to Palm Beach Boulevard are begun, some of the outparcels and parking lots can be redeveloped. Mixed-use, multi-story buildings should front Palm Beach Boulevard with doors and windows facing the street.



Step 2. Existing buildings are redeveloped and the vast parking lot begins to be transformed with buildings defining new streets, with parking located on-street and within the new blocks.



Step 3. As the corridor continues to mature and passenger rail service returns, parking can be reduced and land can be redeveloped with an even greater density and mixture of uses.

Parking garages are not visible from Palm Beach Boulevard and other principal streets; the garages are located mid-block and are lined by habitable space.

The redeveloped shopping center and future rail stop can be a node of urban activity.

In addition to the redevelopment of the corridor, residential infill in adjacent neighborhoods allows more customers, employees and shop owners to live within walking distance of the stores and workplaces, thereby keeping the shops viable while reducing vehicle trips.



Affordable housing could be created in a mixed-income setting using rowhouses and garden apartments arranged along narrow streets and intimate squares.

A modern roundabout could eventually replace the signalized intersection. The roundabout would reduce the need for many of the U-turns that currently take place while improving safety by eliminating turning maneuvers that result in broadside collisions.

Pocket parks and community vegetable gardens should be established simultaneously with neighborhood infill.

Step 4. Corridors should be thought of as the new frontier for urban growth.

Strip malls such as East Fort Myers Shopping Center have languished as newer and fresher buildings were built farther out. These already disturbed urban parcels should not be thought of as “built out” but should rather be part of a strategy for accommodating future population growth without having to develop agricultural lands and pristine wilderness outside the City limits. Most of the commercial parcels along Palm Beach Boulevard have been built as one-story, low-slung buildings; these structures should be regarded as merely the first generation of buildings. The future of this corridor is that of a mature main street with multi-story, mixed-use buildings and where driving is not the only way to enjoy all of the different activities available in the neighborhood. This area is one of the nodes of urban intensity discussed on page 7.12.

CHANGE OVER TIME

Palm Beach Boulevard and Veronica S. Shoemaker Boulevard



Existing Conditions, Palm Beach Boulevard at Veronica S. Shoemaker Boulevard. The parcels of land between the railroad and Palm Beach Boulevard are challenging to redevelop due to their shallow dimensions and odd shapes.



Step 1. First Palm Beach Boulevard's medians are reconfigured and trees are planted along the boulevard and the neighborhood streets. In addition to these public improvements, the first round of infill and redevelopment projects are implemented.



Step 2. Infill and redevelopment continue to occur. Buildings are built closer to the edge of the sidewalk. Surface parking lots are repositioned to the rear and side of buildings rather than along the front.



Step 3. The intersection of Veronica S. Shoemaker and Palm Beach Boulevards is one of the nodes of urban intensity discussed on page 7.12. It is important that infill occur on both sides of Palm Beach Boulevard, producing a sense of spatial enclosure.

A modern roundabout could eventually replace the signalized intersection. This would reduce the need for many of the U-turns that currently take place while improving safety by eliminating turning maneuvers that result in broadside collisions.

Large footprint buildings can be built next to smaller buildings. Redevelopment at this node will provide for pre-game and post-game activities next to Terry Park.

Rowhouses and other urban housing types provide a transition in scale between taller mixed-use buildings on Palm Beach Boulevard and the adjacent existing detached houses on both sides of Palm Beach Boulevard.



Step 4. Conceptual Build Out.

The plan shows one of many ways that this important intersection can be reconfigured and redeveloped over time. Understanding that redevelopment will occur over many years due to existing leases and market feasibility, the plan for properties adjacent to Palm Beach Boulevard and Veronica S. Shoemaker Boulevard is designed to include a phase-able strategy to accommodate the transformation of the area over time. Organizing the area into an interconnected street and block network, the plan demonstrates how both large and small buildings on oddly shaped parcels can be incorporated into the long-term plan for the Boulevard.

By working with landowners, a greenway can be created that provides a walking path between Palm Beach Boulevard and the Caloosahatchee River.

A minor node of urban intensity could provide neighborhood services and retail that may not be present in the major nodes. See page 7.12.

Parking garages are not visible from Palm Beach Boulevard and neighborhood streets; the garages are located mid-block and are lined by habitable space.

TRANSFORM THE BOULEVARD

make Palm Beach Boulevard work for businesses & pedestrians

Palm Beach Boulevard is a central element that connects the neighborhoods of East Fort Myers and has the opportunity to become a signature grand boulevard. In order to accomplish this goal, there must be a change in mindset from viewing the corridor as simply an automobile-oriented thoroughfare for moving through-traffic to instead become, to a cherished component of the community. Rather than allowing it to do just one job, moving the maximum of through-going motorists, East Fort Myers residents and business owners can demand more from this important roadway – that it not only provide an excellent auto experience, but also an excellent walking, cycling, shopping, working, and living experience.



Figure 4.20

Existing Conditions: The continuous median barrier limits access to Palm Beach Boulevard onto cross streets and prevents left turns into businesses forcing drivers to make U-turns. Yet, the dimensions of the Boulevard make it difficult to do so. There are not enough safe places for pedestrians to cross the Boulevard. Cyclists are not comfortable sharing travel lanes because of high traffic speeds, and the sidewalks are too narrow for bicycles when pedestrians are present. Parking lots in front of buildings and a lack of shade trees or shading devices increases discomfort.



Figure 4.21

Portions of the median could be removed without providing a sheltered turning bay. This could be accomplished with a textured marked area that would maintain the appearance of a divided roadway without the physical barrier to left hand turns. A textured area could also serve as a place for emergency response vehicles to pass vehicles that are blocking the travel lanes. An advantage of this feature is that drivers may make left turns directly into the businesses that they wish to visit.



Figure 4.22

A left hand turning bay can be added at more cross streets in order to allow for more frequent turns and reduce the need for U-turns. The overall length of some existing turn bays can be decreased to allow more turn bays, especially at minor intersections. Each one will not be expected to provide storage for more than one or two waiting vehicles.



Figure 4.23

Changes should be implemented that improve comfort and access for pedestrians, cyclists, and users of wheelchairs and strollers. It is necessary to increase the frequency of crossings along the entire length of Palm Beach Boulevard. Crosswalks should be clearly marked or textured, adding a form of traffic calming along the Boulevard. Pedestrian-activated stop lights would also begin to restore the balance in favor of pedestrians. Intersections and crosswalks must be designed to include ADA-compliant ramps and curb-cuts.



Figure 4.24

Additional Refinements: In addition to these changes, pedestrian-scaled lights should be added and bare spots in the planting strips and medians should be planted. Royal Palms should be added in the planting strips, to reinforce the line of existing palms that have been planted there. Palms are a good choice for commercial areas, as they do not block signs and displays of merchandise. In the median, however, there are many options. Royal Palms could be planted there as well, or alternatively native shade trees such as Live Oak or Gumbo Limbo would provide more comfort than just palms. A mixture of Royal Palms and shade trees would also help to lower the temperature of the asphalt. As design speeds are lowered along activity nodes at major intersections, such design changes can be the first step in transforming parts of Palm Beach Boulevard into a main street.

Palm Beach Boulevard - The Next Generation Vision: A long-term goal would be to establish on-street parking, and regulations that maximize redevelopment sites by minimizing set backs and locating parking lots to the rear of the lot, out of site from those strolling, biking, or driving along Palm Beach Boulevard. If passenger rail service can be reactivated on the railroad tracks and some traffic can be shifted to other travel modes, then further traffic calming could occur on Palm Beach Boulevard. It is not difficult to imagine Palm Beach Boulevard as a bustling, tree-lined, transit-served mainstreet - a dignified address for living, shopping, and recreational activities.

CONNECT THE GREEN SPACES

assemble a better green network & enhance connections to the river & creek

The green spaces in East Fort Myers are an asset to the community and have tremendous potential to improve over time. By introducing additional park spaces, both large and small, a green network can be assembled that improves the quality of life in the area and helps to create a more sustainable East Fort Myers. Improved public access to the Caloosahatchee River and Billy's Creek will help to better connect residents to these important waterways. By planting street trees and introducing sidewalks, the park spaces and waterways can be connected and easily accessed by East Fort Myers residents and visitors.

Seminole Avenue Park

The parcels of land located north of Palm Beach Boulevard and west of Van Buren Street have been identified by the City of Fort Myers as an ideal spot for a park. Currently, there is a gap in Seminole Avenue which should be healed by connecting the two dead ends. Then, Estelle Street and Van Buren Street should be connected to Seminole Avenue along the edges of the new triangular park. These streets should be positioned so that a layer of developable lots can be plated around the park, so that natural surveillance may assist in keeping the park safe, and so that more residents and users will be within walking distance of the park. Also, when passenger rail returns, a rail station should be built at the park so that the new development will be supported by the rail. In turn, the development will support the rail by providing housing sites and business within walking distance of the station. The rail station and its accompanying transit-oriented development will reinforce the connection between Palm Beach Boulevard and the railroad, and increase natural surveillance along the railroad right of way.

Not only humans benefit from this design, however. The planting of street trees and trees in and around the park will start to form a continuous overhead tree canopy. This canopy can act as a habitat for birds, pollinator insects, and other creatures, and allows for them to expand their range and move freely across the city in a protective habitat created by branches and foliage. Planting a multi-layered landscape of trees, understory shrubs and groundcover is a landscape that is not only more hurricane-resistant and biodiverse, but also one that cools the city through shade and evapotranspiration.



Figure 4.25: The site plan for the proposed Seminole Avenue Park showing adjacent T.O.D. (Transit Oriented Development) and reconnected street network.



Figure 4.26: Seminole Avenue Park, existing conditions.



Figure 4.27: The redevelopment of the property should include new buildings facing onto the park...

ACTION STEP # 2 SEMINOLE AVENUE PARK

City officials should proceed promptly with its plans to create a new park north of Palm Beach Boulevard in East Fort Myers.

- The city should begin negotiations to acquire vacant land in one or both of the top-ranked sites south of Seminole Avenue and east of Polk Street.
- If land can be acquired, the city should prepare preliminary plans to determine exactly which part of the site should be reserved for the park and which part should be made available for private development.
- The developable portion of the site should be sold to a private developer with suitable restrictions to ensure that Seminole Avenue is completed and that housing faces the park to provide continuing natural surveillance.
- The park portion of the site should either be improved by the city or by the same developer who acquires the remainder of the site.



Figure 4.28: ... and a site for a rail station and Transit Oriented Development (TOD). Page 4.21

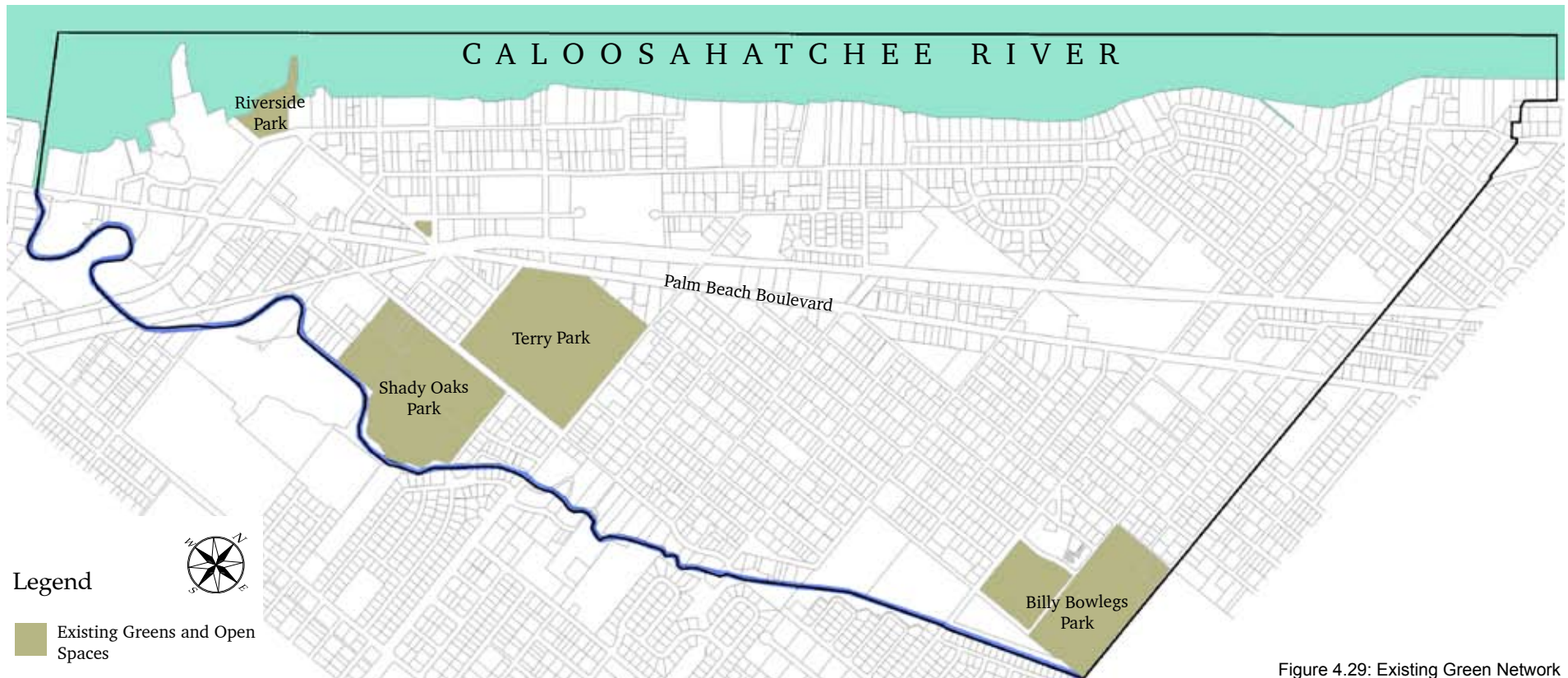

Figure 4.29: Existing Green Network

Many communities struggle with the need to create large recreational and passive green spaces. East Fort Myers already has a number of these types of spaces, which are the beginnings of a first rate “emerald necklace.” East Fort Myers should pursue ways to expand its inventory of small and mid-size parks while simultaneously improving its existing large parks. Also, East Fort Myers has two bodies of water, The Caloosahatchee River and Billy’s Creek, that make its inventory of green space and blue space richer than many peer communities. These bodies of water offer completely different experiences. The Caloosahatchee River is wide, expansive, and a place for fishing, swimming, and kayaking. Billy’s Creek, while also an excellent place for kayaking, has a more intimate, mysterious character, with tree-lined tributaries and meanders that make it a destination for nature enthusiasts.

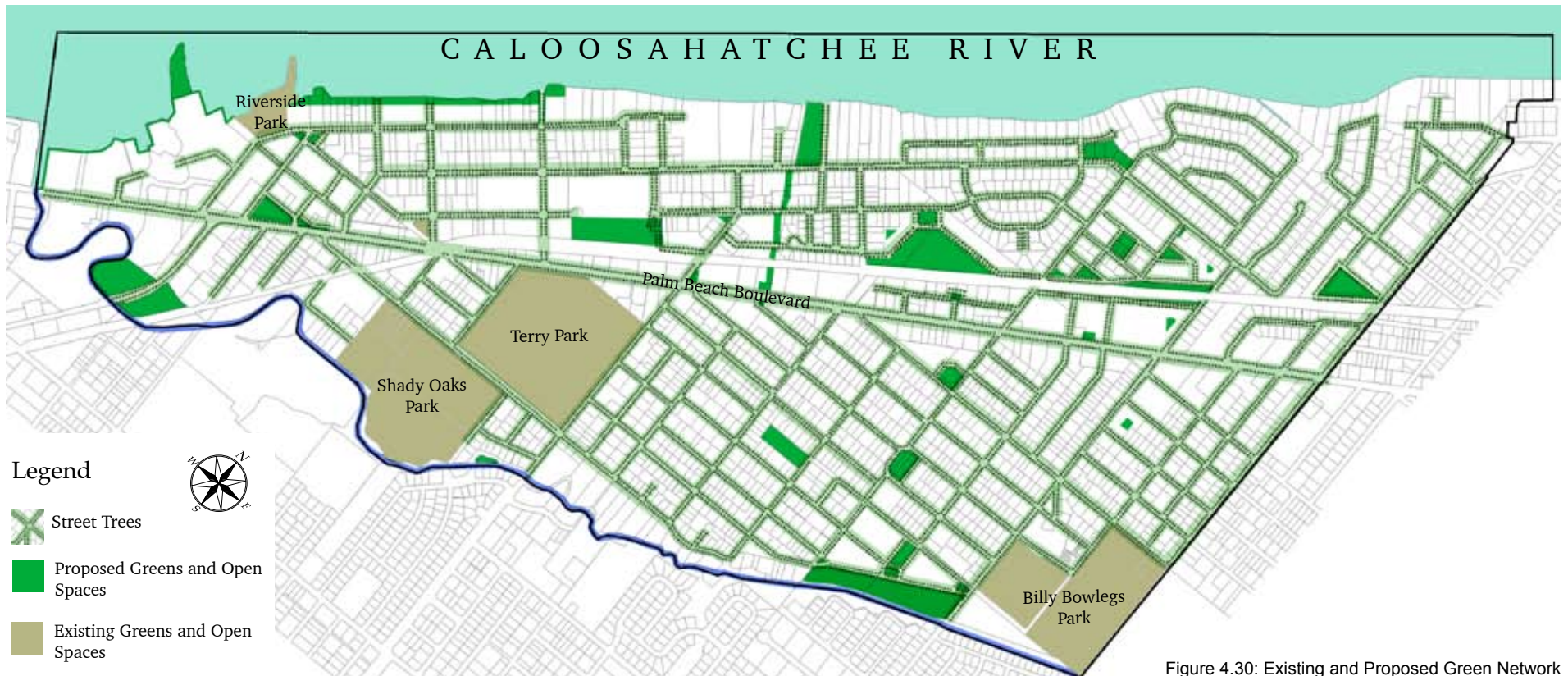

Figure 4.30: Existing and Proposed Green Network

The proposed network of greens includes not only new parks and public spaces but also the streets of East Fort Myers. Often, streets are not thought of as part of a city's green network. Once they have been planted with street trees, they should be included as part of the green network because:

1. They provide canopy continuity and habitat between parks and wilderness areas.
2. Planting strips and swales are a green resource that connects parks, wilderness areas, and water recharge areas at ground level.
3. Shaded streets are the means by which residents reach the parks and other green spaces.
4. Like parks, streets and their sidewalks often serve as a setting for play and recreation in the neighborhoods. Thus it is important to calm the speed and behavior of the drivers that use them.

The City of Fort Myers should take advantage of current depressed land values to acquire several additional parcels that over time can become part of a more complete network of greens and open spaces. Several such sites are suggested in this report. In addition to acquiring more green space, the School District should consider opening school fields to the community after school hours and on weekends and holidays.

GREENING THE STREETS OF FORT MYERS

The urban heat island effect refers to a phenomenon by which asphalt and other dark materials absorb sunlight during the day, causing higher temperatures in urban areas. Where vegetation is dense and materials are reflective rather than absorptive, the urban heat island effect can be mitigated. It is imperative that East Fort Myers embark on a tree-planting effort. Not only will this shade asphalt from direct sunlight, but pedestrians and cyclists will likely find the streets more comfortable to use. The transpiration of the new trees will also contribute to the cooling of East Fort Myer's Streets.

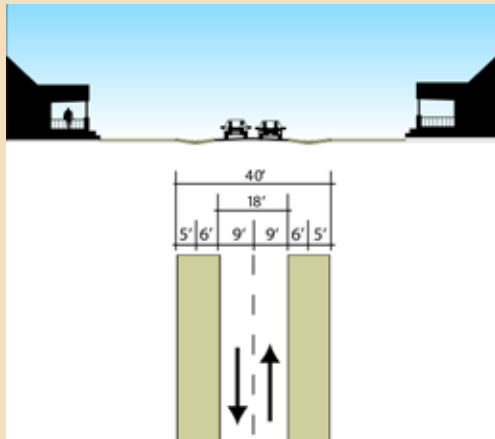

Before:

The existing street section has two lanes of traffic, without sidewalks or trees. There are ditches on the side of the road, and houses are spaced too far apart to produce a sense of spatial enclosure.



Before:

A street design like this, lacking in sidewalks and shade, is undignified and uncomfortable for pedestrians, who are forced to walk on the hot asphalt.

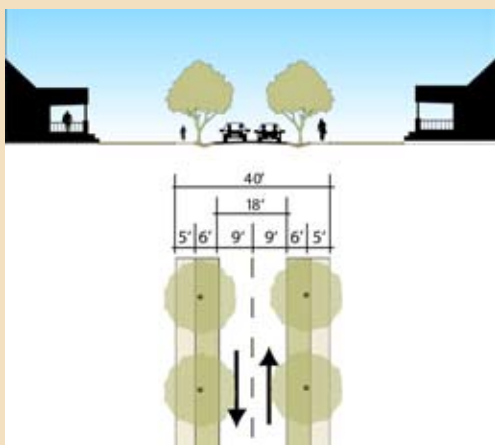

After:

Sidewalks and trees can fit in this right-of-way. The trees correct the wide feeling of the street, providing a sense of spatial enclosure where the buildings fail to do so. Not only do the trees help shade the sidewalk and asphalt, but they also help calm the traffic speeds.



After:

A street design like this, which provides sidewalks and shade, is a more comfortable and dignified setting for both pedestrians and cyclists. Parking under a continuous canopy of trees also helps cars' inside temperature to not exceed the ambient temperature.

STREET TREE PHASING



Phase One:

In the first phase of planting, Florida Royal Palms (*Roystonea elata*) should be planted in the blank spots of Palm Beach Boulevard's side planting strips. Then, once the initial median refinements have been carried out, Florida Royal Palms or a native shade tree should be planted in the remaining blank spots in the central median.

STREET TREE PHASING



Phase Two:

In the second phase of planting, portions of principal streets are selected on both sides of Palm Beach Boulevard to receive street trees. These streets are the ones that link neighborhoods or parks together, such as East Riverside Drive, Edgewood Avenue, Marion Street, Veronica S. Shoemaker Boulevard, Van Buren Street, Marsh Avenue, Woodside Avenue, and Madison Avenue. Rather than palms, which are part of the identity of Palm Beach Boulevard, these streets should receive native shade trees that have spreading canopies. Where drainage improvements are needed on particular blocks, street tree planting will necessarily be delayed until the drainage improvements are put into place.

STREET TREE PHASING



Phase Three:

In the third phase of planting, portions of other neighborhood streets are selected to receive street trees in planting strips. When these streets are planted, they will help create a continuous urban tree canopy that one day could shade all of the streets in East Fort Myers. Again, where drainage improvements are needed on particular blocks, street tree planting will necessarily be delayed until the drainage improvements are put into place.

STREET TREES FOR EAST FORT MYERS

Palm Beach Boulevard

Florida Royal Palm *Roystonea elata*

All Other Streets

Cabbage Palm *Sabal palmetto*
Florida Royal Palm *Roystonea elata*
Gumbo-Limbo *Bursera simaruba*
Jamaican Dogwood *Piscidia piscipula*
Laurel Oak *Quercus laurifolia*
Live Oak *Quercus virginiana*
Mastic *Sideroxylon foetidissimum*
Paradise Tree *Simarouba glauca*
Pigeonplum *Coccoloba diversifolia*
Persimmon *Diospyros virginiana*
Red Bay *Persea borbonia*
Red Maple *Acer rubrum*
Red Mulberry *Morus rubra*
Satinleaf *Chrysophyllum oliviforme*
Silver Buttonwood *Conocarpus erectus var. sericeus*
Sugarberry *Celtis laevigata*
Mahogany *Swietenia mahogani*
Wild Tamarind *Lysiloma latisiliquum*



ACTION STEP # 3 PLANT STREET TREES

In order to reduce the urban heat island effect and restore habitat, street trees should be planted along all streets within the study area.

- Use native species for all new street tree plantings.
- In order to increase biodiversity use a wide variety of tree species throughout the study area rather than a single species.



transportation 5

INTRODUCTION

The East Fort Myers Revitalization and Redevelopment Plan provides for strategies to improve both a main corridor, Palm Beach Boulevard, and the mobility options of the neighborhoods that surround it. During the June 2008 design charrette, Hall Planning & Engineering (HPE) worked with the rest of the consultant team to address the challenges facing Palm Beach Boulevard and neighborhood streets. The charrette included interviews with stakeholders to identify transportation issues, as well as an examination by HPE of the area's transportation context. HPE studied traffic speeds and street designs, conducted interviews with City Public Works and Planning staff, and met with local citizens and citizen groups.

The purpose of the charrette was to propose design solutions that could revive the economic life of the streets in the study, including addressing safety concerns associated with pedestrian crossings of the Palm Beach Boulevard. HPE's goal during the charrette was to specifically address issues associated with recent installation of medians along the corridor, and provide a transportation design solution to match the future land use context of the surrounding area. HPE's recommendations in this report are designed to address these issues.

East Fort Myers is a coastal Florida community with a long history and a close proximity to downtown Fort Myers. A downtown Master Plan by Duany Plater-Zyberk is beginning to be realized and is helping to create an attractive, functional, walkable downtown area. The roads feeding downtown, however, are conventionally-scaled arterials with very low levels of walkability. Palm Beach Boulevard, which provides access on the east side of downtown to I-75, is a historically important road that has developed over time into an arterial with strip commercial and automobile-oriented uses. The neighborhoods on the north and south sides of Palm Beach Boulevard, however, largely retain their historic street networks, and even without sidewalks give rise to comparatively high levels of walking and bicycling. A context map of the area is shown in Figure 5.1.

Many local residents do not own automobiles, relying on public transportation, walking, bicycling, and ride-sharing. High levels of pedestrian activity separated by an un-walkable arterial between them lead to predictable safety problems. In 2007, the Florida Department of Transportation converted Palm Beach Boulevard within the study area from a five lane road with a center turn lane to a four lane road with a nearly continuous median barrier, which greatly restricts turning opportunities into businesses and even into many side streets. Several unmarked mid-block crossings are designed to increase pedestrian safety.

The medians have generated extremely negative reactions. Although pedestrian injuries and deaths have decreased dramatically, drivers have lost convenient access to many businesses. The medians were installed after opportunities for public comment on the design, so the negative reaction surprised many city and state officials. The original proponents of adding medians were equally surprised to find that their idea of occasional median islands resulted in a nearly continuous barrier along Palm Beach Boulevard.

Median islands were originally part of a larger plan to make the corridor safer and more inviting to pedestrians. As implemented, the continuous medians have indeed made it safer for pedestrians to cross, but otherwise have made the corridor more suitable for traffic passing through than for local use by residents, businesses, and their customers.



Figure 5.1: Area Map - Palm Beach Boulevard Corridor.

From a transportation planning context, HPE recognizes the following issues for the study area, based on conversations with the community and observations during the charrette:

1. Palm Beach Boulevard Design
 - a. Refining the medians -- immediate
 - b. Pedestrian access -- immediate
 - c. Street design changes over time -- intermediate and long term
 - d. Access management and arterial classification -- immediate
 - e. Traffic signals -- intermediate and long term
2. Bicycle Access -- intermediate
3. Transit -- intermediate
4. Neighborhood Streets -- intermediate
5. Shared Parking -- intermediate

1. PALM BEACH BOULEVARD

America's suburban land development pattern results from many factors, including street and highway networks that routinely dictate its structure. Highways designated as arterials change little as they approach developed areas. Generally speeds drop from 55 to 45/35 mph, but on-street parking is usually not allowed in emerging areas and is often removed from older areas. Arterial street designs, by definition, tend to exclude intersections with side streets of limited volume, leading to longer block size (600 to 1,000 feet and higher) and higher speeds 45 mph or more, both of which cause difficulty for pedestrians. The arterial design concept emerged from a rural heritage and rarely serves urban peak travel demand well due to exclusive reliance on the single facility serving a single mode – the motor vehicle.

To achieve urban places that encourage (and thrive with) pedestrians, bicycles, and transit vehicles as part of the mobility mix, the patterns of proposed development must be specified first, during the community planning stage. Then, transportation plans for balanced mobility can be crafted with walkability considered first and vehicle mobility second. This is not to imply that motor vehicle mobility will be dramatically reduced. Rather, pedestrians exposed to the open environment are more vulnerable than when they are drivers, and solutions for their comfort are more complex. Often, greater walkability yields only small reductions in vehicle capacity, even though vehicle speeds are lower. Generally more streets per square mile result from a more open network and drivers can avoid the degree of peak hour congestion that occurs when a limited number of large streets break down.

Palm Beach Boulevard is a typical edge-condition arterial street with suburban, single-use development along both sides. As with many similar streets in other towns, Palm Beach Boulevard has begun to “grey out” or undergo a general decline in economic value.

In 2002, the city of Fort Myers approved a *Palm Beach Boulevard Community Plan* that included proposals for median islands, the creation of walkable areas with buildings brought up to the street, and other ideas for creating resilient urban spaces. The Florida Department of Transportation has its own priorities for installing medians to limit access from adjoining property to arterial roads; that particular recommendation of the community plan was funded almost immediately. The median design actually installed by Florida DOT is overly restrictive for local traffic and requires some immediate adjustments.

Refine the Palm Beach Boulevard Medians

The medians along Palm Beach Boulevard were installed to increase safety in the corridor, by prohibiting head-on crashes and providing pedestrian crossing refuges. The existing curb-to-curb width of Palm Beach Boulevard within the study area, however, is insufficient in most places to allow the U-turn maneuvers that are needed on median-divided streets. For a future land-use context with a more urban site design (buildings at the back of sidewalk, for instance, and vehicle access through rear lanes), such as that envisioned in the previous study, the street width would be less of an issue. However, many land uses along Palm Beach Boulevard today still retain their most recent form and function as automobile-oriented uses, such as large truck repair and shopping centers requiring large truck access. The medians have proven to be problematic for these businesses and their customers. The medians were also designed to improve pedestrian access and safety, yet fatalities have not been eliminated entirely, and pedestrians do not seem to be using the medians as much as anticipated.

HPE recommends the following refinements to the medians to address these issues:

1. Create additional median openings
2. Place openings to permit U-turns
3. Realign some existing openings

The existing median openings are shown in Figure 5.2, and in Figure 5.3, additional openings should be added to provide access to streets that still need large truck service. Some of these openings are also placed to permit U-turns at intersection locations, by using more of the intersection width, but some of the medians should be relocated to better serve the existing land uses.



Figure 5.2: Existing Median Openings

In February 2009, Florida DOT held a public workshop in East Fort Myers to present their reevaluation of the new medians.

The major change proposed by Florida DOT was to improve the ability of motorists to make U-turns at about six existing median openings by adding “flare-outs” as described on the next page of this report. These flare-outs would replace the grassy strip between the curb and sidewalk with additional pavement so that medium-size and larger vehicles could make U-turns in a single motion. A number of the new pedestrian crossings would be removed.

In addition, one additional pair of directional turn-lanes would be installed across the existing median barrier near the railroad crossing. However, state officials rejected the idea of any of the additional median openings recommended in this report, which were characterized as “violations of state standards.”

Unless Florida DOT officials are willing to reconsider, the only solution for the overly restrictive medians may be for the City of Fort Myers to take over maintenance responsibility for Palm Beach Boulevard from the state. Swapping of maintenance responsibility takes place frequently for a variety of reasons and could be accomplished by mutual agreement of the parties.



Figure 5.3: Current and Proposed Median Openings along Palm Beach Boulevard. The added median openings are needed as noted above from east to west; a directional opening at Prospect Avenue would serve longer trips on the north side due to the rail crossing.

Prior to the installation of the medians, travelers on Palm Beach Boulevard could turn left into a driveway directly from the center left turn lane. With the installation of the medians, however, travelers often need to go past their destination and execute a U-turn to enter these same driveways. Several methods for executing U-turns are shown in Figures 5.4 and 5.5. Based on these figures, and given the width of Palm Beach Boulevard, the best U-turn method in most locations is that shown in the third option of Figures 5.4 and 5.5, the “jug handle” U-turn. The proposed new median openings and relocations in Figures 5.2-3 above provide space to allow U-turns at intersections where this technique can be used.

Minimum Width of Median for “U” Turn on 4 Lane Road

Measure in feet	Passenger P	Single Unit SU	Semi Trailer WB-50
 Turn Lane to Inner Lane	42	75	83
 Turn Lane to Outer Lane	30	63	71
 Turn Lane to Shoulder	20	53	61

Figure 5.5: Minimum Median Width for U-Turns

OPTIONS FOR U-TURNS

In order to handle u-turns there are essentially three options available:

1. Wide medians

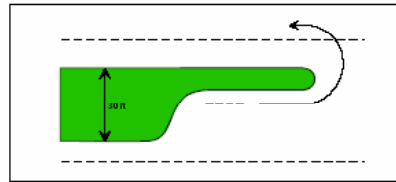

2. Median “Bulb-Out”

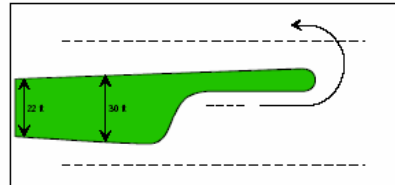

3. Flare-Out (Jug Handles)

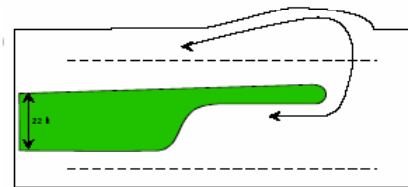

MEDIAN HANDBOOK 

Each of these options has their strengths and weaknesses. Traffic, land use and terrains will play important roles in the decision on their options.

Figure 5.4: Options for Making U-Turns

ACTION STEP # 4

PALM BEACH BOULEVARD MEDIANS

State officials were overly zealous when designing the new median barriers in Palm Beach Boulevard. City officials must press Florida DOT to immediately reconfigure the medians.

- At least a half-dozen additional median openings can be added to allow easier movement by motorists and to reduce the need for U-turns.
- Some existing median openings can be opened further to allow access to adjoining businesses.
- U-turns are nearly impossible for larger vehicles where there are only four travel lanes; adjustments are needed at some locations to allow more vehicles to make U-turns.
- Pedestrian crossings should be made more visible to pedestrians and motorists with a repeated theme such as clusters of small trees and night-time lighting.
- These changes should be designed and constructed within the next twelve months, after which the planned landscaping can be installed.



Figure 5.6: Pedestrian Crossing Cuts in Median

Pedestrian Access

The medians have pedestrian crossing openings at mid-block locations, indicated in Figure 5.6. The medians provide pedestrian crossing access as shown in Figure 5.7, using an at-grade walkway opening through the median. However, as is also shown in Figure 5.8, the curbs on either side of the cut have not yet been provided with curb ramps or other indications that crossings are expected in these locations, so access is still limited. As shown in Figure 5.8, some pedestrians are using the median turn lanes as crossing points, creating a number of conflicts. In addition, the pedestrian crossing cuts are difficult to spot, as they tend to blend into the median itself, although the median design does anticipate adding landscaping and other features to call attention to the crossing cuts.

ADA-compliant curb ramps should be added at pedestrian crossing locations, along with signs (MUTCD W11-2, Figure 5.9) and lighting to indicate the location of the crossing areas. At the speeds typically observed along Palm Beach Boulevard, between 35 and 45 mph, stopping sight distance is at least 300', so "pedestrian crossing ahead" signs should be placed no less than 325' upstream of the pedestrian crossing. See excerpt below from the MUTCD (Manual of Uniform Traffic Control Devices) regarding placement of these signs. Given the generally low level of pedestrian crossings per hour (<14), crosswalks are not recommended. In locations where crossings in excess of 14/hour are observed, however, NCHRP 562 Improving Pedestrian Safety at Unsignalized Crossings should be consulted to determine what additional treatments, including crosswalks, may be warranted on a case by case basis. NCHRP 562 provides an alternative warrant analysis to the MUTCD pedestrian crossing signal/marking warrants and appears to be more appropriate for creating walkability and pedestrian safety.



Figure 5.7: Median pedestrian crossing; opposite curb does not have a ramp for wheelchair access.



Figure 5.8: Pedestrians crossing at median break. A pedestrian-only crossing is located just out of the frame on the left.

The use of fences or other devices to discourage pedestrian crossings is not recommended. As shown above, pedestrians are already crossing in the vehicle median cuts, and these are impossible to fence off without also restricting automobile access. This plan recommends even more median cuts, so a fenced median would be compromised in many locations, making a fence more of an annoyance than a safety measure. Also, a fence could potentially trap pedestrians in the street.

Figure 5.10 illustrates the odds of a pedestrian surviving a collision at various speeds. Note that at 45 mph, the signed speed along Palm Beach Boulevard, a pedestrian has an 85% chance of being killed in a collision with an automobile. At 30 mph, the odds decrease to 45%, and at 20 mph the chances are only 5%. Based on this chart, the most effective way to improve pedestrian safety in the corridor is to lower the vehicle speeds as much as possible. While 20 mph may be achievable in the town center locations, described below, 30 mph is a reasonable design speed for the rest of Palm Beach Boulevard within the study area. Various methods are available to help achieve these operating speeds, including additional landscaping to create greater enclosure, narrowing the lane widths, and synchronizing traffic signals at the lower speed. At high-volume crossings (>20 pedestrians/hour), additional measures including raised and marked crosswalks, in-pavement lighting, and overhead pedestrian-activated red signals may be considered. As a demonstration project, a hi-visibility crosswalk and pedestrian-activated signal should be installed at one of the future town center locations (described in greater detail below). To achieve the desired 30 mph travel speed, the following elements should be included:

- Curb-extensions to narrow the travel lanes to 10.5 feet at the crosswalk
- Advanced sign and pavement markings to alert drivers of the crossing
- Signage and hi-visibility crosswalk markings at the crosswalk (the “continental” style markers are recommended)
- Overhead pedestrian-activated signal with flashing red lights
- In-pavement lighting

Selection of the demonstration project location should be based on the intended future land use as well as current activity. Ideally, the location would have 14 or more pedestrian crossings per hour during peak usage and be located in an area planned for future redevelopment. Over time, the drivers will become accustomed to the crosswalk and lower speeds in this area, transitioning to greater walkability in the area with additional redevelopment.

Section 2C.41 Non-vehicular Signs (W11-2, W11-3, W11-4, W11-6, W11-7, W11-9)

Option:

Nonvehicular signs (see Figure 5.2C-10) may be used to alert road users in advance of locations where unexpected entries into the roadway or shared use of the roadway by pedestrians, animals, and other crossing activities might occur.

Support: These conflicts might be relatively confined, or might occur randomly over a segment of roadway.

Option:

When used in advance of a crossing, Nonvehicular warning signs may be supplemented with supplemental plaques (see Section 2C.43) with the legend AHEAD, XX METERS (XX FEET), or NEXT XX km (NEXT XX MILES) to provide advance notice to road users of crossing activity.

Standard:

When used at the crossing, Nonvehicular signs shall be supplemented with a diagonal downward pointing arrow (W16-7p) plaque (see Figure 5.2C-11) showing the location of the crossing.



W11-2

Figure 5.9: Pedestrian Crossing Sign Recommended for Palm Beach Boulevard Midblock Crossings

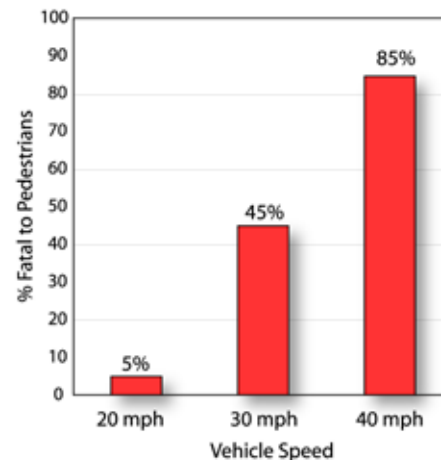

Figure 5.10: Pedestrian Fatality Odds by Vehicle Speed

2. BICYCLE ACCESS

The constrained pavement width of the corridor does not allow for the installation of bike lanes. Even if bike lanes were present, the frequent driveway cuts would represent an additional hazard for cyclists using the bike lanes.

To create a truly safe and inviting environment for cyclists, the automobile speeds must be managed to walkable levels of 25-30 mph. At this speed, sharing the lane with motorists becomes the preferred transportation option for cyclists. The recommended town center street design includes on-street parking, tree plantings, short block lengths, and building enclosure to achieve this desired travel speed.

Because of the proximity of relatively walkable neighborhoods north and south of the corridor, there is a high level of bicycle traffic along the corridor. Most of these cyclists can be considered “utility cyclists” who use the bicycle primarily for transportation, as opposed to recreation (see Figure 5.11). The cyclists in the corridor were observed to use the sidewalk, as opposed to a bike lane or riding in the regular travel lane, even where a bike lane was provided along Palm Beach Boulevard between Seaboard Street and Park Avenue. This may be due to the high vehicle speeds along this 45 mph corridor. At speeds above 30 mph, cyclists (and pedestrians) tend to avoid interaction with motor vehicle traffic if at all possible.



Figure 5.11: Most Cyclists Observed in the Corridor were "Utility Cyclists" Who Ride Primarily for Transportation

3. TRANSIT ACCESS

Recognizing that automobiles powered by fossil fuels are likely to have a diminished presence in our lives, the plan for East Fort Myers must make convenient public transit one of its priorities. This includes the resurrection of passenger railway service through the study area. In the meantime, transit-ready development will create an environment that is conducive to transit usage. Walkability is a key element in creating a high level of transit ridership. Unless the origins and destinations of the trip are walkable, transit will have little chance to encourage shifts from automobile to transit usage. As the new town centers along the corridor are developed, transit shelters should be included in the streetscape design. Transit provisions should be coordinated with Lee Tran to ensure compatibility with local transit planning and operations.

Starting in 1926, East Fort Myers was nearly the center of rail transportation in Lee County. Although the Seaboard Air Line tracks were removed in the early 1950s, the Atlantic Coast Line tracks that run parallel to Palm Beach Boulevard have been in continuous service for freight and are now also used for excursion trains.

During the past several decades, cities across the country have begun new passenger rail service. Most new systems are in cities much larger than Fort Myers but often smaller than Lee County as a whole. Development patterns in many parts of Lee County are spread too thin to ever support passenger rail service, but the existing rail corridor runs through populated mixed-use areas that could benefit from fast efficient public transportation: Naples–Bonita Springs–Estero–Fort Myers–East Fort Myers–Punta Gorda. If tracks were added to a missing link north of Punta Gorda, rail service could be provided from Naples through Fort Myers to Sarasota, Bradenton, and Tampa.

The map on this page, Figure 5.12, shows the existing Seminole Gulf rail line in southwest Florida. The pink areas on this map indicate urbanized land (and other disturbed land such as phosphate mines). Florida DOT recognizes the potential for restoration of passenger rail service in southwest Florida. It has been investigating the purchase of the entire rail right-of-way for its continued use for freight trains or for adding passenger rail or even Bus Rapid Transit BRT service.

There is an interesting parallel in southeast Florida for reintroducing passenger rail to urban areas. When Florida DOT realized that it would take five years to widen I-95, it began offering offered rail service in 1989 on a parallel route crossing three counties. “Tri-Rail” was so successful that it continues to grow today, linking West Palm Beach, Fort Lauderdale, and Miami.

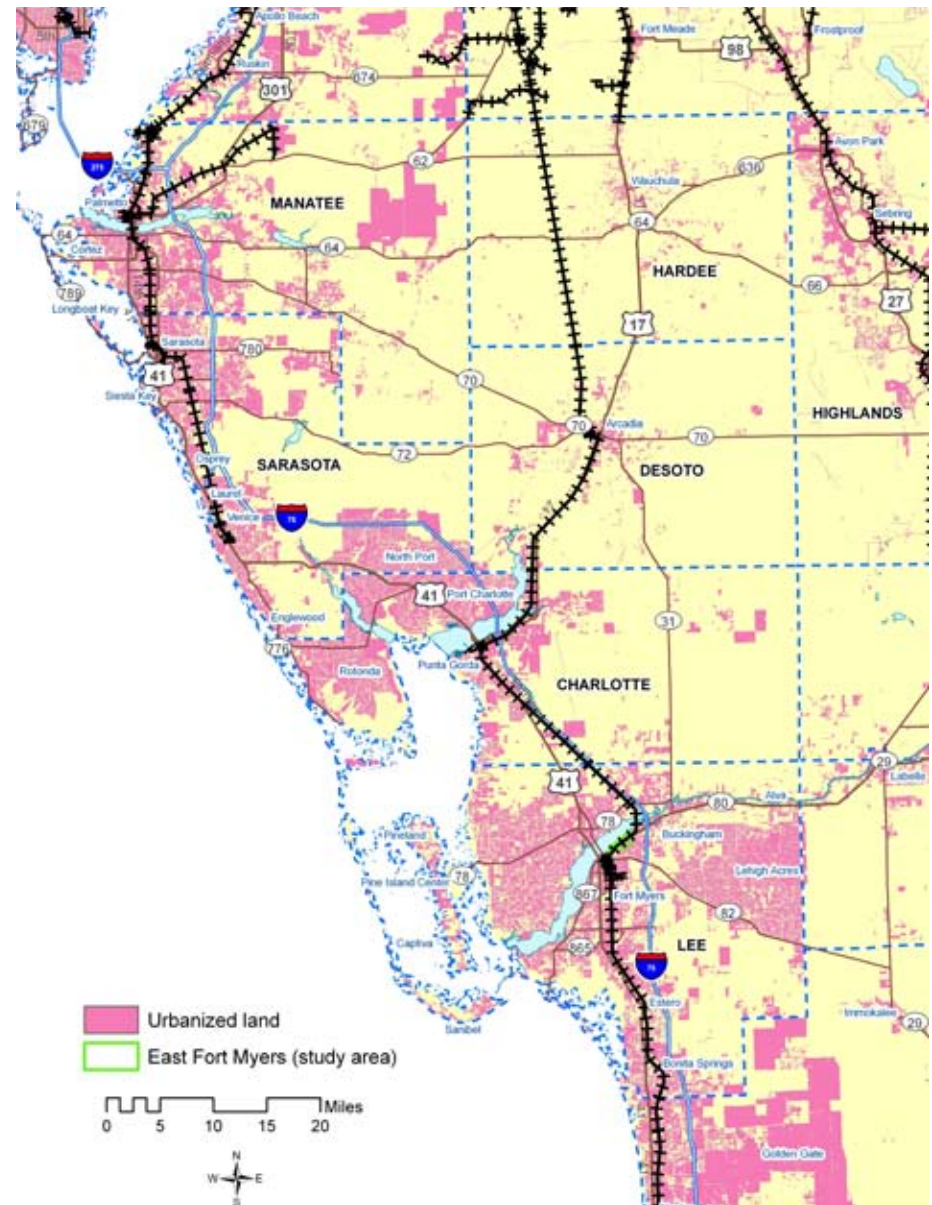

Figure 5.12: Railroad tracks in southwest Florida.

The map below, Figure 5.13, was created in 1939 and shows the greatest extent of railroad tracks in southwest Florida. Comparing this map to Figure 5.12 on the previous page, it is clear that about half of the original rail network was later removed.

An era of seemingly inexhaustible and cheap gasoline made rail transport seem obsolete. However, the remaining rail rights-of-way provide an opportunity for southwest Florida to begin diversifying its transportation network.



Figure 5.13: Map reproduced from "Florida: The American Guide Series", (courtesy of the Southwest Florida Historical Society)

All public transit service in Lee County is provided by Lee Tran, an agency of county government.

Bus service is provided on Palm Beach Boulevard, Veronica Shoemaker Boulevard, and Marsh Avenue, on two routes:

- Route 20, which runs from downtown Fort Myers to the U-Save shopping center at the corner of Palm Beach Boulevard and Marsh Avenue.
- Route 100, which runs from downtown Fort Myers to SR 80 at Buckingham Road.

Routes 15 and 20 do not enter the East Fort Myers study area, but they do provide service to nearby neighborhoods. Despite the limitations of these schedules, East Fort Myers is better served by public transportation than most other parts of Lee County. On weekdays, Route 20 operates with about 35 minutes between buses; Route 100 operates every 30 minutes.

Under current funding limitations it is unlikely that bus service will be increased. A higher priority has been assigned to additional bus routes to unserved portions of Lee County than increased service on existing routes, either by shortening wait times or improving evening and weekend service.

One promising avenue for increasing transit service would be the creation of an independent transit authority which would be a partnership between Lee County and its cities. A transit authority would have the power to levy taxes for public transit, either a property tax or a sales tax, and might be able to obtain authority to levy gasoline taxes as well.

A transit authority has been in the discussion stage for many years, but recent months have seen very encouraging progress. All five of Lee County's cities have now signed interlocal agreements establishing an oversight committee to move forward with this concept.

The oversight committee will develop a consensus as to the composition of the authority's board and a dedicated funding source for public transit, then formulate the legislation needed to formally establish the authority.

Another type of transit improvement was studied this past year: establishment of "bus rapid transit" or BRT. BRT uses rubber-tired vehicles like regular buses, but they often travel on special rights-of-way and employ train-like boarding procedures to provide fast and comfortable service.

A detailed study looked at the potential for BRT service on Palm Beach Boulevard, US 41, Colonial Boulevard, and Martin Luther King/Lee Boulevard. The study concluded that BRT has strong potential only on US 41 and the Colonial Boulevard corridors. The study made these conclusions based upon the existing land use and urban form of Palm Beach Boulevard, not based upon the desired transit-supportive development that is proposed in the East Fort Myers Revitalization and Redevelopment Plan.



Figure 5.14: Lee Tran bus routes, with East Fort Myers study area outlined with red dashes.

The red line shows the route of the proposed passenger railway service. Red circles indicate the possible locations of rail stations. The blue line, which runs along Palm Beach Boulevards, shows the proposed bus or streetcar route. Blue circles indicate the locations of bus or streetcar stops. The bus or streetcar can occupy one of Palm Beach Boulevard's car lanes. At certain key stops and stations, the bus or streetcar stops should be coordinated with the nearby Passenger Rail stations in order to facilitate transfers between the two transit modes. Such transfer areas should have a great variety of convenience retail and services. Transit stations and stops can give rise to an diverse and vital economy of small businesses which are not currently possible in this automobile-oriented corridor.

ACTION STEP # 5
CITY LEADERS SHOULD ENCOURAGE LEE COUNTY IN SUPPORTING BETTER PUBLIC TRANSPORTATION.

Fort Myers should vigorously support a Lee County Transit Authority to provide better public transportation through the county and particularly in more urban areas.

- Fort Myers should push for the authority to levy a gasoline tax in order to fund transit improvements.
- Fort Myers should encourage the MPO and Florida DOT to make long-term arrangements to allow the existing rail line to also be used for passenger service.



Figure 5.15: Proposed Transit Connections

4. NEIGHBORHOOD STREETS

An interconnected street network is an essential component of a functional transportation system. A healthy street network is characterized by small blocks and by streets that do not have dead-ends. Rather, streets should connect to other streets. An interconnected street network is better able to disperse and accommodate car traffic than a disconnected pattern. Disconnected patterns have also been shown to increase VMT (vehicle miles traveled) and thus increase carbon dioxide emissions. Interconnected street networks are also more convenient for cyclists and pedestrians because they provide more direct routes to destinations, and more varied routes as well. Currently, Palm Beach Boulevard handles many short trips between neighborhoods that are made difficult by the current state of the street network. Traffic pressure on Palm Beach Boulevard could be reduced if the street network were made more complete, giving drivers more alternative routes from which to chose.

As mentioned in previous sections of this report, the neighborhoods adjacent to Palm Beach Boulevard on the north and south have potential for increasing walkability. The blocks tend to be rather long in the east-west direction (600-700') but are not excessively long in the north-south direction (300-400'). Many of the streets go only 1200' or so before an off-set intersection, which is also a traffic calming measure. Over time, these neighborhoods have potential to fit well with more pedestrian-oriented businesses, shops, and services along Palm Beach Boulevard. In fact, the planning team saw people circulating between the neighborhood and the corridor during the site visit. To fully realize the potential of these areas, however, the current street section should be modified.

A typical street in this neighborhood is shown in Figure 5.16, and diagrammed in Figure 5.17. This street design includes capacity for significant stormwater drainage, which limits some of the options for alternative street designs. On-street parking, for instance, would require piping the swales to maintain drainage functions. This will add to the cost of any improvements. Alternatively, the new street section shown in Figure 5.18 retains the swales but includes sidewalks as well. The recommended design fits within the existing 40' ROW for most of the neighborhood streets and would provide an alternative to walking in the street. The street trees, planted on the back side of the swales, would have a traffic-calming effect by creating additional enclosure along the street, as well as providing shade for pedestrians.



Figure 5.16: Typical Street on South Side of Palm Beach Boulevard, two 9' lanes, swales, no sidewalks.

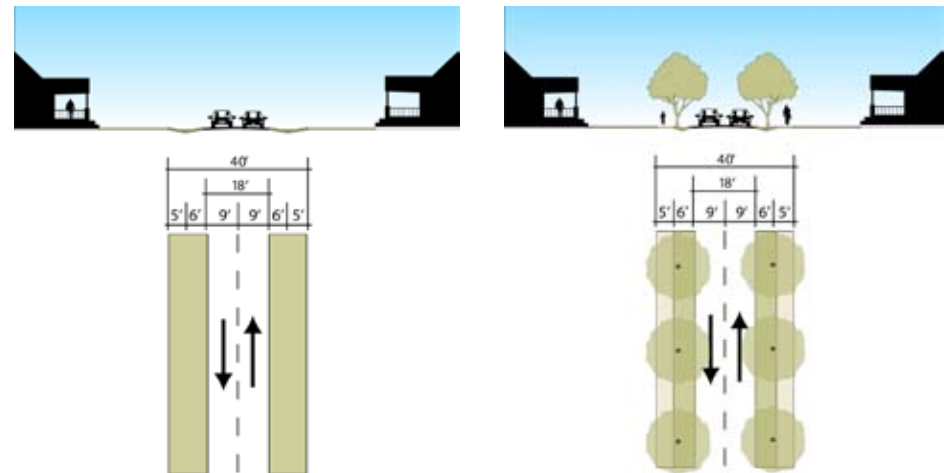

Figure 5.17: Existing Neighborhood Street Section

Figure 5.18: Proposed Section for Neighborhood Streets

While some neighborhoods in East Fort Myers have a fine-grained block and street network, other neighborhoods have a high number of dead-ends or oversized blocks. Wherever possible, dead-ends should be remedied by connecting them to the existing street network. Likewise, oversized blocks should be subdivided in order to create additional streets. Improving the interconnectivity of the street network will not only help reduce VMT and increase convenience for pedestrians, but will also help increase a sense of natural surveillance by allowing for dead-end street segments to become part of the day-to-day commuting patterns of pedestrians, drivers, and cyclists. More activity in the street implies greater safety for its users.



Figure 5.19: Existing Street Network

ACTION STEP # 6 **CREATE MISSING STREET LINKS**

City officials should incrementally construct missing links in the East Fort Myers street network.

- In most cases, rights-of-way already exist for these missing links. Fort Myers officials should identify high-priority missing links and search for opportunities to construct them during the coming years.
- Where right-of-way does not yet exist but a connection is needed, land should be acquired either through the platting process at the time of development or through voluntary acquisitions in advance of development.



Figure 5.20: Existing and Proposed Street Network

In 2007 the city commissioned a study titled *Sidewalks in Fort Myers: Toward a Community-Oriented Construction Policy* by Glatting Jackson Kercher Anglin, Inc. The map on this page, Figure 5.21, presented as Figure 5.2 of that study, shows that East Fort Myers has the most deficient sidewalk network in the entire city. Other deficient areas within the city are concentrated on land annexed from Lee County in 2003 in the Dunbar and Belle Vue areas.

CITY OF FORT MYERS
EXISTING SIDEWALK INVENTORY

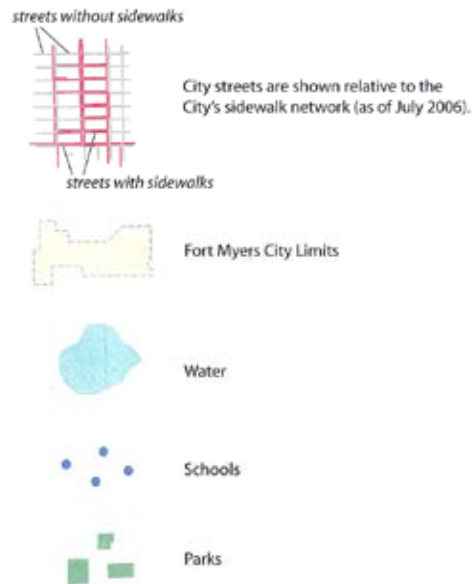

Figure 5.21: Existing Sidewalk Inventory for the City of Fort Myers

The report *Sidewalks in Fort Myers: Toward a Community-Oriented Construction Policy* presented a plan for constructing sidewalks on both sides of any existing street segment that is part of the “effective network” (“effective network” refers to street segments that connect to other streets). That report also presented a way of prioritizing certain street segments and ways for residents along certain segments to opt out of improvements.

ACTION STEP # 7
BEGIN TO COMPLETE THE PEDESTRIAN NETWORK

Install sidewalks as recommended by *Sidewalks in Fort Myers: Toward a Community-Oriented Construction Policy*. The recommendations included in this previous study are still valid, but should be expanded to include the following considerations:

- Construct new streets and sidewalks in order to reduce the number of dead-ends in East Fort Myers, thereby increasing the number of streets counted as part of the “effective network.”
- Eliminate the possibility of certain residents’ opting out of sidewalk improvements through petition.
- Facilitate those residents who are not part of the “effective network” to opt in by reducing percentage of petition signatures that are currently required, or designate all dead-end streets are part of the “future effective network.”



Figure 5.22: Existing Pedestrian Facilities



Figure 5.23: Existing and Proposed Pedestrian Facilities

5. MANAGED PARKING

Additional parking will be mitigated by the ability to park once and use other modes such as transit, walking and bicycling, but will also be mitigated by the ability to share parking between land uses in a managed parking arrangement.

Conventional/existing development patterns along Palm Beach Boulevard today require separate parking lots for each land use. Even if land owners were willing to share parking lots, the distance between land uses is often too great to encourage walking and customers would end up driving anyway. Conventional parking standards are applied in this case. They require a certain number of parking spaces for each land use and assume that each land use is stand-alone – i.e., that a customer doing laundry will require a parking space at the Laundromat and will require another parking space at a restaurant if he decides to get a sandwich while his clothes are in the dryer.

Managed parking recognizes that in urban locations, such as the re-designed Palm Beach Boulevard, with high levels of walkability and easy, attractive pedestrian access between land uses, separate parking lots might not be needed for each land use. Instead, land uses and lots may share parking. For example, an office building that is open during the day requires parking for its employees during business hours, but not during the evening when the office is closed. A dinner restaurant/club requires parking at night, but not during the day when the restaurant/club is closed. Under conventional parking demand, each land use would require its own parking supply, even if they were located adjacent to one another. Shared parking recognizes that the same parking lot can serve both uses with minimal amounts of overlap (there will probably be some demand for office parking at night and restaurant parking during the day, if only for maintenance staff and management.)

To estimate the reduction in conventional off-street parking due to shared parking, professionals typically utilize a shared parking guide published by the Urban Land Institute. Another potential source is the SmartCode, which incorporates shared parking principles to determine parking demand. As the Palm Beach Boulevard corridor develops, these shared parking methodologies should be used to estimate parking requirements. However, these methodologies require specific information about each parcel, which is impossible to obtain for future parcels since the parcels have not yet been redeveloped. Therefore, the term “managed parking” has been used in this document, with the understanding that shared parking methodologies will be applied as new development comes on line. The managed parking approach requires that conventional parking codes and ratios not be used in this area.

The critical parking concept to remember regarding the Palm Beach Boulevard corridor is to let the urban form (including a mix of uses, on-street parking, and buildings built up to the street), help mitigate the demand for parking. Then use shared parking to accommodate the demand. These strategies will ensure not only that adequate parking always exists in the corridor, but will also ensure that buildings rather than parking lots will define the character of the corridor.

Function	with		Function
RESIDENTIAL			RESIDENTIAL
LODGING			LODGING
OFFICE		1	OFFICE
COMMERCIAL	1.4	1.1	1.4
	1.2	1.7	1.2
	1.3	1	1.3
	1.2	1.2	
		1	

Figure 5.24. This is an example of a shared parking reduction table produced by from Duany Plater-Zyberk's Smart Code Version 9.2. In order to use a shared parking reduction table, first calculate the required number of parking spaces from the applicable parking regulations, then determine the uses present in the project being designed. Lastly, divide the number of parking spaces by a coefficient in the above table that corresponds to the uses that will be incorporated in the project.

Palm Beach Boulevard - The Next Generation Vision

Street Design Changes Over Time

Palm Beach Boulevard today reflects its recent use as an arterial with suburban strip development. The long term plan for the corridor includes conversion of land uses and design to an urban main street, with smaller blocks and more intensive development in some locations. Transportation impacts, such as additional traffic from more intensive development, will be met in part by the shift in travel mode away from driving to more walking, bicycling, and transit use. This shift is not difficult to envision, if one considers the existing neighborhood structure north and south of Palm Beach Boulevard. This structure includes relatively small block sizes, with potential for more intense residential and mixed use development (T4 and T5 development using the New Urbanist Transect classifications, to be discussed later in the report). Indeed, the level of walking and bicycling that exists along the corridor today is an indicator of the potential for increased walkability if the design of the street itself can nurture this shift.

A phased implementation of a more walkable street design should occur as the land use and urban form along the corridor become more walkable. For example, a conventional shopping center, set back from the street across a sea of parking spaces, may be convenient for drivers but is not easily approached by pedestrians. Over time, however, the shopping center can be redeveloped as a town center, with buildings brought up to the street and the lot broken into a series of smaller blocks with improved walkability. Redeveloped shopping centers would become less monolithic, with commerce distributed on smaller parcels much like the pattern that is evident in downtown Fort Myers today.

There are several advantages to this urban form. The small blocks and additional streets, built to “main street” standards (on-street parking and managed speeds), provide capacity for additional traffic, while also providing the ability to walk and bicycle safely due to the managed vehicle speeds on these smaller town streets. This shift of some car trips to other modes of travel helps mitigate traffic impacts. Additional internal trip capture also becomes possible due to a greater mix of uses in the town center design. Typically, town centers include residential, commercial, office, and institutional land uses in the same development. The walkable design permits residents and workers to walk or bicycle for many routine trips, such as to get a meal or run an errand, thereby reducing vehicle trip generation compared to conventional single-use designs.

HPE worked with Dover, Kohl & Partners during the charrette to develop a “typical” progression from the existing Palm Beach Boulevard to a future design with mixed use, town center development. This progression is illustrated and



Figure 5.25: Potential New Town Center Locations

described below. According to the land use plan created during the charrette, town centers could be developed at the locations indicated in Figure 5.25. Note that the town centers are confined to a few specific locations along the corridor – for portions that are not town centers, the current street design would be preserved, with the minor modifications described above (additional/refined median openings and refined pedestrian crossings).

In Figure 5.26, see the existing condition of Palm Beach Boulevard, with four lanes of traffic and a center median. A narrow planting strip and sidewalk on each side of the street provide separation between the boulevard and a large parking lot, which itself serves conventional suburban land uses. Driveway cuts are frequent along the corridor, as each lot has its own driveway access to the corridor. The high operating speed of 45 mph requires the median for safer pedestrian crossings. Over time, the parcels along the street will redevelop, with buildings coming up to the street, wider sidewalks, and urban

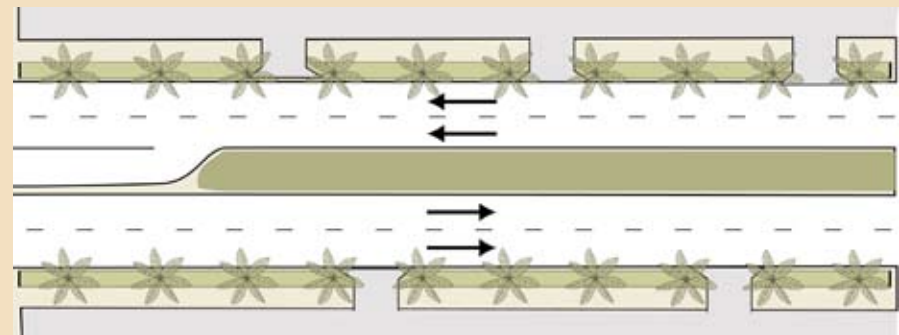

Figure 5.26: Existing Conditions Plan View

design that encourages and supports walking. This is illustrated in Figure 5.27 (refer to Transforming the Boulevard on page 4.18). The street design responds to this change by eliminating the median in the redeveloping portion of the corridor and adding on-street parking. The on-street parking manages the travel speeds to walkable levels, so the median can be swapped out for on-street parking, without losing pedestrian safety. Driveway cuts begin to be eliminated, as buildings are brought up to the street. This, in turn, improves the access-management design of the corridor.

The process continues in Figure 5.28, and Figure 5.29 shows a complete transition from suburban arterial to urban main street design. The design speed is now a walkable 30 mph, versus 45 mph, so bicycles can share the lane with automobiles, as indicated by the “sharrow” shared lane markings adjacent to the on-street parking. Driveway cuts are eliminated and replaced with store fronts. A wide, inviting sidewalk encourages and supports walking, increasing ease of access from the surrounding neighborhoods and creating a “park once” environment. The “park once” environment allows motorists to park and make several trips on-foot, rather than making each trip by car. This design reduces VMT as well as circulatory automobile traffic.

The proposed plan and section design for this “town center” Palm Beach Boulevard is shown in Figure 5.30. It features buildings built to the back of sidewalk, 12’ sidewalks with trees in treewells, 8’ parking lanes, and 2 10’ travel lanes in each direction. At intersections where turning movements are expected and allowed, the on-street parking is dropped to allow room for a center turn lane.

The removal of the median and addition of on-street parking, as well as additional town-center traffic circulation, can be expected to have an impact on vehicle travel through the corridor, measured as a change in the arterial level of service (LOS). The existing arterial LOS was calculated using Synchro™, a traffic microsimulation program from Trafficware, Inc., for a section of Palm Beach Boulevard between Veronica Shoemaker Boulevard and New York Street, and compared that to a hypothetical town center development along this same portion of Palm Beach Boulevard.

Under the comparison, westbound arterial Level of Service (LOS) at the PM peak hour remained LOS B. For eastbound travel, the arterial LOS was A under the existing conditions and B under the town center conditions. Travel

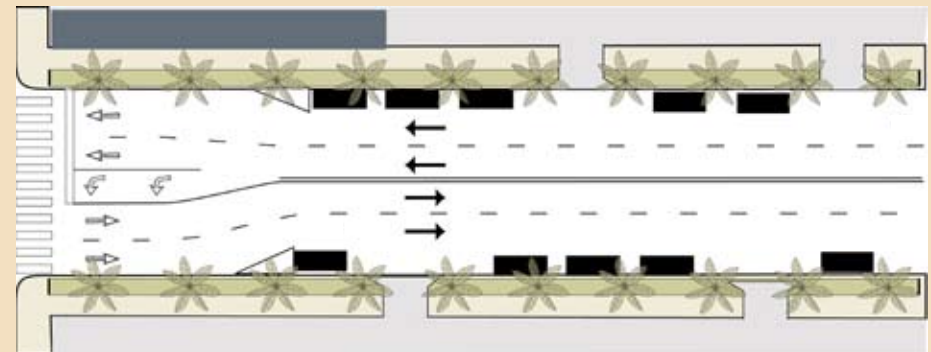

Figure 5.27: Beginning of Transition from Suburban Arterial to Town Center Street

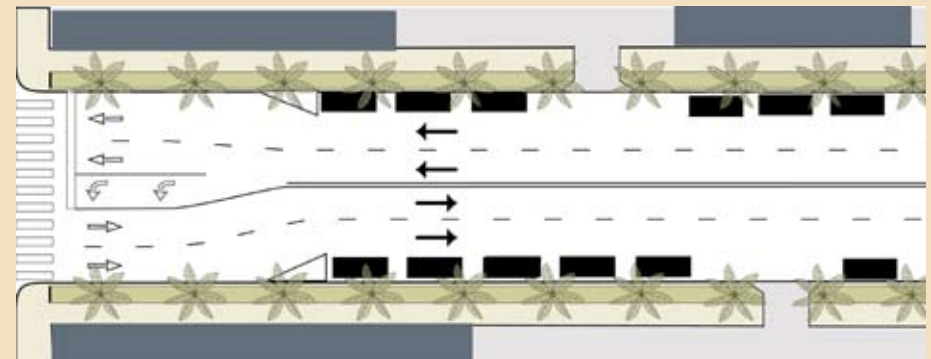

Figure 5.28: Continued Transition to Town Center – Fewer Driveways, More On-Street Parking

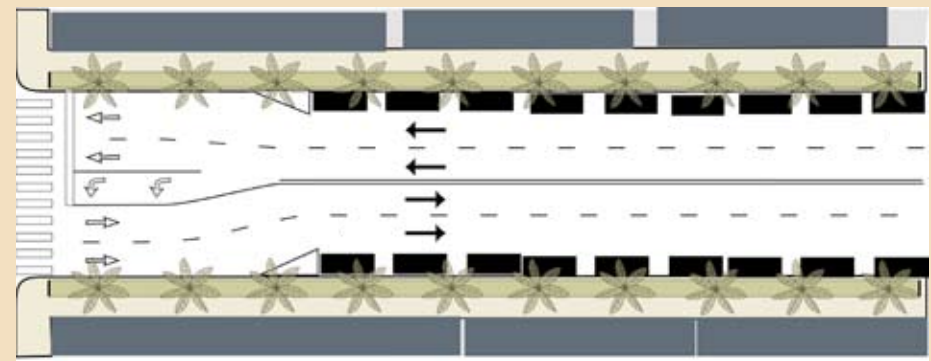

Figure 5.29: Final Transition to Town Center; On-Street Parking; No Median; No Driveways

versus town center scenarios, respectively. These results are shown in Figure 5.31, Existing Conditions Arterial LOS and Figure 5.32, Town Center Conditions Arterial LOS. The modifications between the two scenarios included adding a traffic signal at Oleander Street, projecting additional circulatory traffic around the town center, and lowering the arterial speed from an un-walkable 45 mph to 30 mph, which is the upper limit for a walkable street.

Access Management and Arterial Classification

As a state highway, Palm Beach Boulevard falls under the state of Florida's Access Management Standards (Rule 4-97) and the Florida Green Book, which is based on the AASHTO Green Book standards for arterial design. To implement the design changes recommended here, Palm Beach Boulevard should be placed in Access Management Class 7, which allows closer intersection and signal spacing and more frequent median cuts. As an alternative, the City can request a variance from FDOT from the current access management classification. In addition, the corridor should be classified as a Class IV Arterial under the AASHTO classification standards. This will allow a lower design speed and more frequent intersections, both of which are critical for town center development.

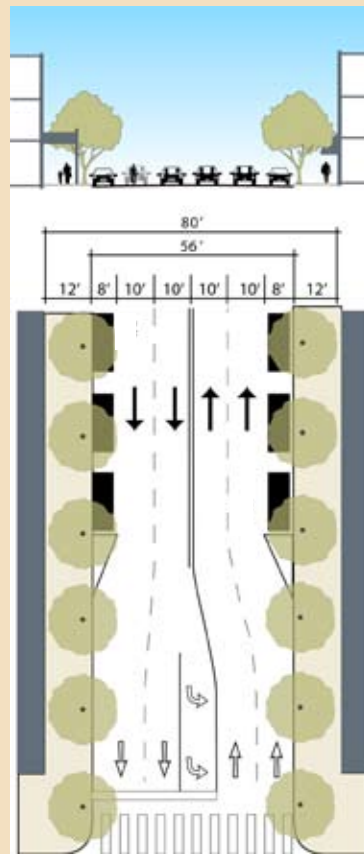

Figure 5.30: Proposed Town Center Street Section

Arterial Level of Service: EB Palm Beach Blvd

Cross Street	Arterial Class	Flow Speed	Running Time	Signal Delay	Travel Time (s)	Distance (mi)	Arterial Speed	Arterial LOS
Points west to Veronica Shoemaker Blvd	II	45	67.6	8.9	76.5	0.84	39.8	A
VSB to Marsh St	II	45	69.8	26.2	96.0	0.87	32.7	B
Marsh St to New York Dr	II	45	39.8	7.0	46.8	0.42	32.5	B
Total	II		177.2	42.1	219.3	2.14	35.1	A

Arterial Level of Service: WB Palm Beach Blvd

Cross Street	Arterial Class	Flow Speed	Running Time	Signal Delay	Travel Time (s)	Distance (mi)	Arterial Speed	Arterial LOS
Points east to New York Dr	II	45	42.5	5.6	48.1	0.47	34.9	B
New York Dr to Marsh St	II	45	39.8	28.5	68.3	0.42	22.3	C
Marsh St to Veronica Shoemaker Blvd	II	45	69.8	4.7	74.5	0.87	42.2	A
VSB to Seaboard St	II	45	67.6	40.2	107.8	0.84	28.2	B
Total	II		219.7	79.0	298.7	2.61	31.4	B

Figure 5.31: Estimated Arterial Level of Service for Existing Conditions

Arterial Level of Service: EB Palm Beach Blvd

Cross Street	Arterial Class	Flow Speed	Running Time	Signal Delay	Travel Time (s)	Distance (mi)	Arterial Speed	Arterial LOS
Seaboard to Veronica Shoemaker Blvd	II	45	67.6	8.9	76.5	0.84	39.8	A
VSB to Oleander	II	30	84.4	11.4	995.8	0.70	26.4	C
Oleander to Marsh St	II	30	22.6	20.7	43.3	0.17	14.0	E
Marsh St to New York Dr	II	45	39.8	7.0	46.8	0.42	32.5	B
Total	II		214.4	48.0	262.4	2.14	29.4	B

Arterial Level of Service: WB Palm Beach Blvd

Cross Street	Arterial Class	Flow Speed	Running Time	Signal Delay	Travel Time (s)	Distance (mi)	Arterial Speed	Arterial LOS
Points east to New York Dr	II	45	42.5	5.6	48.1	0.47	34.9	B
New York Dr to Marsh St	II	45	39.8	22.8	62.6	0.42	24.3	C
Marsh St to Oleander	II	30	22.6	4.5	27.1	0.17	22.4	C
Oleander to Veronica Shoemaker Blvd	II	42*	61.0	7.4	68.4	0.70	37.0	A
VSB to Seaboard	II	45	67.6	40.2	107.8	0.84	28.2	B
Total	II		233.5	80.5	314.0	2.61	29.9	B

*Average flow speed based on combined 30 mph/45 mph links between Oleander and Seaboard St

Figure 5.32: Estimated Arterial Level of Service – Town Center Design

Traffic Signals

Existing traffic signals, as warranted, are shown in Figure 5.33. Additional traffic signals may be required over time to support town center development. Recommended locations for these signals are shown in Figure 5.34. These signals should be coordinated to provide the most efficient flow of traffic along the corridor, and for management of vehicle speeds. Spacing on more urban locations is needed for safer pedestrian crossing and speed management.

Figure 5.34 is for illustrative purposes only. Actual locations of proposed signals are to be determined by responsible agencies.

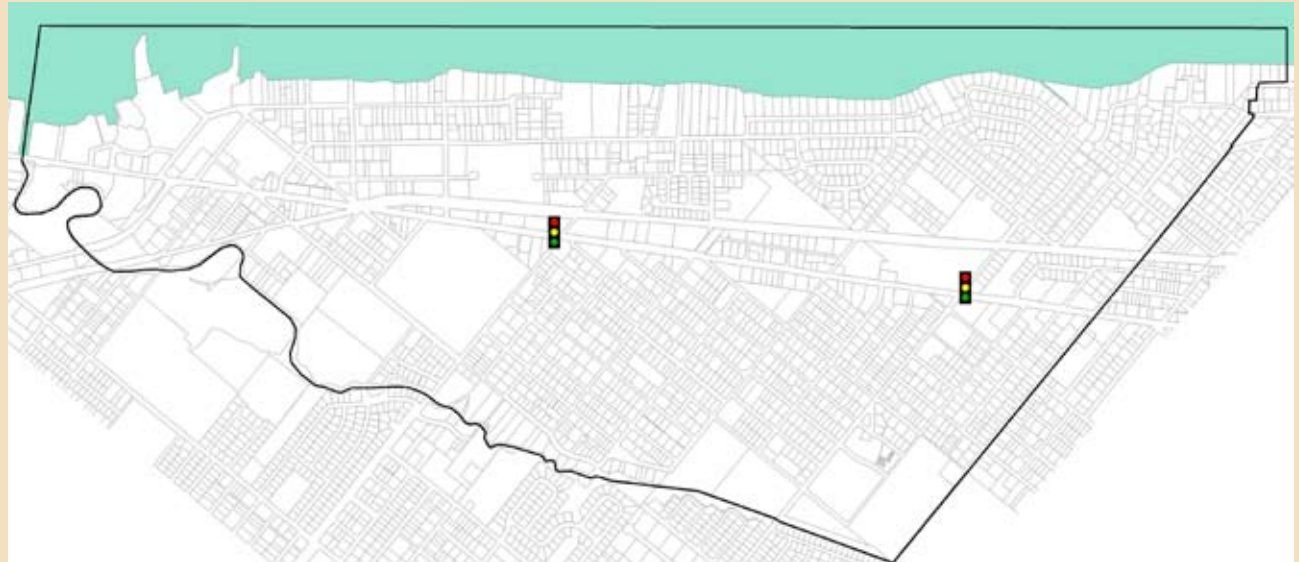

Figure 5.33: Existing Signals



Figure 5.34: Existing and Proposed Signals, as warranted

CONCLUSION

Citizens, local officials, and business owners interested in East Fort Myers all express a strong desire to continue the redevelopment of the area. The configuration of the new medians requires some immediate fine-tuning while longer range improvements are contemplated. The following items identify the highest transportation priorities:

- Modifications to the median to immediately provide access at key locations.
- Modification and additional signs and lighting to increase the usability and safety of the mid-block pedestrian crossings.
- Addition of sidewalks in the neighborhood streets to allow safer access and circulation for adults and children.
- Addition of street trees on the neighborhood streets for traffic calming and pedestrian support.
- Encourage transit-ready development at key locations.
- Use of managed parking methodologies to minimize the number of parking spaces required as part of redevelopment.

Palm Beach Boulevard – The Next Generation

The following steps describe the idealized future of a multi-modal and sustainable transformation of Palm Beach Boulevard. In this glimpse of the future, a balance has been established between the needs of motorists, pedestrians, cyclists, and transit riders. Urban form is intense and vibrant around the stations; shifts toward transit and other low-emitting vehicles have improved air quality in the study area and lowered greenhouse gas emissions. Residents are able to access downtown, other neighborhoods, and most gathering points within East Fort Myers. They are able to choose from a great variety of mobility options.

In this future, they will be able to live a high-quality lifestyle without having to own an automobile. Because walking is “built in” to the fabric of the neighborhoods and the corridor, physical fitness is encouraged rather than hindered by the built environment. Such a multi-modal, mixed-use, and attractive environment will enable those residents who do not have access to a car to engage fully with their city and neighborhood and will facilitate the exchange of goods and services within the study area and beyond. This combination of transportation infrastructure and urban fabric will be important in bringing back a robust economy to the study area and to the City overall. It is also the most meaningful way that the City can tackle its responsibility to reduce its share of greenhouse gases that emanate from the transportation sector. Next-generation recommendations include:

- Activation of passenger rail service on the Seaboard Air Line and introduction of transit (technology to be determined in the future) on Palm Beach Boulevard will help to reduce Vehicle Miles Traveled (VMT), allowing for Palm Beach Boulevard’s design to undergo further transformations.
- Reduction of the overall corridor speed to 30 mph for pedestrian safety, with specific changes at the mid-block crossings to reinforce the lower speed.
- Changes over time to match the design of Palm Beach Boulevard to the changing form of the adjacent land uses, allowing the corridor in some locations to transform from a four-lane divided arterial to a town center street with on-street parking.
- Addition of traffic signals as new town centers develop.

PAGE LEFT INTENTIONALLY BLANK



environment 6

EAST FORT MYERS: AN ENVIRONMENTAL OUTLOOK

The ability to increase the quality of East Fort Myers as a human habitat cannot be separated from the need to restore its natural environment. For many years, the interests of nature have been seen as antagonistic to the needs of humans. One of the goals of the charrette was to determine how these realms overlap and to decide how both realms can be improved simultaneously and to each other's benefit.

During the charrette, the team's environmental consultant met with citizens, developers and local officials to assess the issues in the study area. Meetings with the City's stormwater consultant, Environmental Consulting Technology, Inc. (ECT, Inc.) and the city engineering staff were conducted to cover any outstanding issues with flooding or problem areas. Meetings with Lee County Waterways Coordinator and Total Maximum Daily Load (TMDL) Coordinator took place to cover the areas of water access and water quality. South Florida Water Management (SFWMD) staff project managers were also invited to participate in the charrette and provide input to the process as their agency is one of the primary funders of environmental projects in the area.

In addition, two follow-up meetings took place to jump-start a few of the processes discussed during the charrettes. One meeting with the City Stormwater Engineer and the Lee County TMDL Coordinator was a working session to identify funding priorities and grant opportunities in the Billy's Creek Watershed. A follow-up meeting with the City's Planning Department staff focused on setting up a Land Trust for conservation land and easements, a mechanism that currently does not exist in the City.

Billy's Creek Restoration

Billy's Creek is a tidally influenced creek located within the City of Fort Myers, Florida. Parts of the shoreline and most of the watershed of Billy's Creek have been altered by development, and it is considered an urbanized creek. Its watershed includes mixed urban land uses, with the majority being residential. Billy's Creek empties into the Caloosahatchee River after it flows under Palm Beach Boulevard between 2nd St./Seaboard St. and Palm Avenue. The upper reaches of Billy's Creek cross Ortiz Avenue. Several canals and ditches drain into Billy's Creek after capturing stormwater runoff from roads and neighborhoods.

Water quality sampling is currently being performed monthly at 6 stations within Billy's Creek and its watershed by Lee County and the City of Fort Myers. Biological sampling has also been conducted in parts of the creek by the Florida Department



Figure 6.1: Aerial of Billy's Creek

ment of Environmental Protection (DEP) to assess the bottom and shoreline habitat, as well as the biological community. The results of both water quality and biological sampling confirm that Billy's Creek has been considerably degraded and does not provide optimal conditions for biological communities.

Specifically, the water quality issues of concern in Billy's Creek are: nutrients, dissolved oxygen, and fecal coliform bacteria. Billy's Creek has high concentrations of nutrients, including both nitrogen and phosphorus, as compared to other tributaries in the Caloosahatchee basin, as well as compared to what would be considered natural nutrient concentrations. Nutrient pollution can cause a host of problems, including algae blooms, aquatic weed proliferation, negative effects to fish and aquatic flora and fauna communities, and low dissolved oxygen levels. Depressed dissolved oxygen levels can negatively affect fish and other aquatic life. Dissolved oxygen levels in Billy's Creek frequently drop below the threshold level of 4 mg/L that is considered to be protective of fish and other aquatic life in marine systems.

Analysis of the data from Billy's Creek by the DEP has not been able to attribute the low oxygen levels to a specific pollutant such as nutrients. Fecal coliform bacteria levels in Billy's Creek are exceeding state standards. High levels of fecal coliform bacteria in surface waters are used as an indicator of increased risk

to humans of infection from other pathogenic organisms. The presence of high levels of these bacteria is usually associated with contamination of fecal material from mammals or birds, although it has been shown that this is not always the case. The DEP has listed Billy's Creek as an impaired waterbody for fecal coliform bacteria under the TMDL program. The TMDL program, implemented by the Florida Department of Environmental Protection (DEP), is a watershed assessment program that identifies waterbodies that are not meeting their designated uses due to their water quality. Billy's Creek is a Class III waterbody, which means that it is designated for recreation (fishing and swimming) and the propagation and maintenance of a healthy well-balanced population of fish and wildlife. An "impairment" means that a waterbody is not meeting state water quality standards for a particular parameter (e.g. fecal coliform bacteria), and must be cleaned up. The first step after an impaired designation is to set a TMDL, which defines the amount of a particular pollutant that can be assimilated by a waterbody, while still meeting its designated use (recreation and healthy fish and wildlife). Once the TMDL is set, a Basin Management Action Plan (BMAP) is developed to identify the sources of pollutants, and how to reduce them. A TMDL is scheduled to be established for Billy's Creek by 2009.

The sources of pollution to Billy's Creek are predominately from non-point source inputs. Non-point sources are those that diffuse and wash into the creek through stormwater or shallow groundwater. The urban watershed contributes stormwater runoff that generally includes: lawn clippings, vegetative debris, fertilizers, pet waste, oil and other pollutants from roads, and sediments. The Billy's Creek watershed may also be contributing septic system leachate and graywater (laundry water). In addition, Billy's Creek has a problem with urban debris and trash being directly dumped into the creek or washed into the creek during storm events.

Progress is being made in the efforts to address Billy's Creek's water quality problems. In addition to the TMDL program, there are other efforts underway. One effort that will likely have a positive impact on Billy's Creek is the Stormwater Master Plan for the City of Fort Myers, which has been updated and is available in draft form. Clean-up events to physically remove trash from Billy's Creek are also organized periodically. Ongoing efforts over the past few years have resulted in the Creek getting funds for dredging and restoration. Approximately \$5 million has been awarded for one major project on the Creek, the Billy's Creek Filter Marsh, located on the north side of the Creek at the eastern edge of the project area. Groundbreaking took place in September 2008 and the park is expected to open in late 2009. The Billy's Creek Filter Marsh is a passive-type water quality improvement facility that consists of a reconstructed



Figure 6.2: Billy's Creek cleanup



Figure 6.3



Figure 6.4



Figure 6.5



Figure 6.6: Existing storm drains



Figure 6.7



BILLY'S CREEK FILTER MARSH PARK

AUGUST 27, 2008

ECT
Environmental Consulting & Technology, Inc.
4150 Swarthmore Avenue, Suite 112
Fort Myers, Florida 33918
(239) 279-0001

DAVE M. KING & ASSOCIATES, INC.
LANDSCAPE ARCHITECTS AND PLANNERS
225 BARKER AVENUE, SUITE 100, GUNDA, FLORIDA 33908
PHONE: 813-937-1100 FAX: 813-937-1100
LIC. 0000000

Figure 6.8: Plan of Billy's Creek Filter Marsh

wetland disguised as a nature park. The Filter Marsh was jointly funded by the City of Fort Myers, Lee County and the South Florida Water Management District (SFWMD).

Community Budget Improvement Requests (CBIR) requests for the area have been ongoing from the State of Florida legislative delegation. A \$500,000 award was given to The Friends of Billy's Creek in 2006 for maintenance dredging of the Creek. In addition, Federal Emergency Management Association (FEMA) funds were used after the 2004-2005 hurricane seasons to clean the Creek of downed trees that were blocking the Creek flow and aggravating upstream flooding.

Caloosahatchee Partners for Restoration (CPR), a committee formed by SFWMD to fund projects in the Caloosahatchee River basin, has consistently ranked Billy's Creek #1 on list of projects from Lee, Glades and Hendry Counties. This ranking is voted by all of the representative communities including municipal and county officials. The high public profile of this project and the increased benefit to the public should continue to keep the Creek in the forefront for restoration. In addition, the City's project planners have identified an additional site for another filter marsh on the south side of the Creek (outside of the East Fort Myers study area). This new potential filter marsh would be on the City of Fort Myers' South Wastewater Treatment Facility property located along the tidal portion of the Creek and would cleanse the water from the Ford Street Canal. This site is currently covered with Brazilian pepper trees, so this site would also be a major habitat improvement for the area.

One of the major ongoing issues for the Creek, that will be necessary for the long term restoration, is dredging of the creek bottom to remove decades of sediment buildup. This is the first major step necessary for the channel bottom habitat restoration. The Creek is part of the tidal Caloosahatchee estuarine system; that is, saltwater species exist at the lower portion of the Creek. The first mile of the Creek from the mouth at the River consists of meandering arched mangrove tunnels. No major habitat studies have been performed on the Creek itself, but wildlife sightings are frequent and it appears to be an excellent area for habitat restoration and wildlife viewing in an urban area.

As part of a complete watershed assessment, other contributing factors may be studied. For example, since the main source of pollution in the watershed appears to be Non-point Sources (NPS), a good indicator of watershed health is an assessment of impervious surfaces. Generally, a watershed is considered

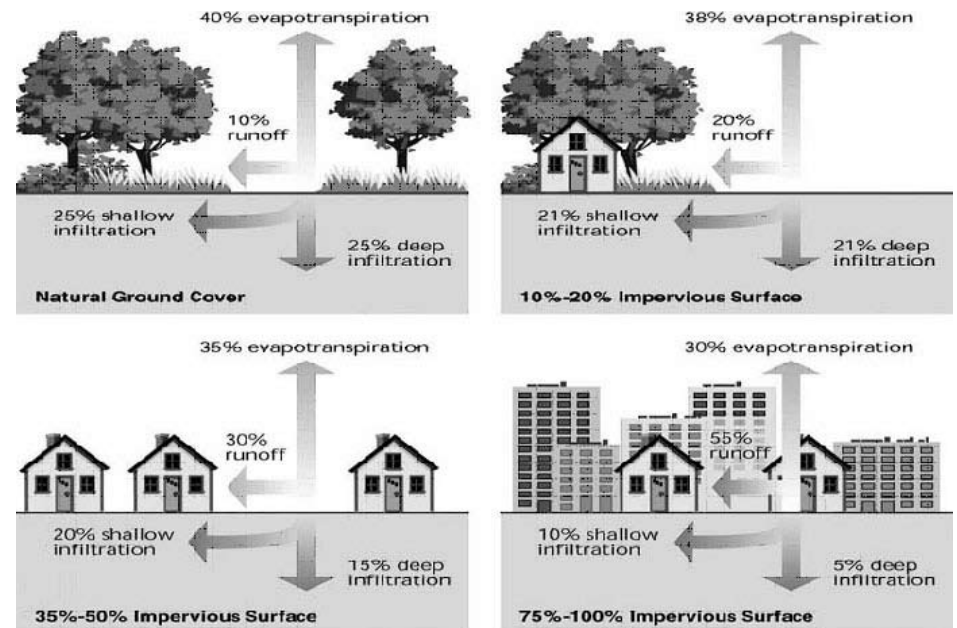

Figure 6.9: Impervious surface percentages

healthy when less than 10% is impervious surface, impaired in the 10-25% range, and beyond restoration over 25% impervious. Until an adequate assessment can be made of this watershed, every effort should be made to reduce – or at least not increase – the amount of impervious surfaces in this impaired watershed.

Caloosahatchee Riverfront

One community park, Riverside Community Center, dominates the Caloosahatchee Riverfront. The park has a large all-purpose building with a meeting /performance hall and classroom space. The Park also added two waterfront amenities in recent years that were funded by Lee County Tourist Development Council (TDC) tax funds. A 140' floating dock for paddlecraft and a large fishing pier were constructed to provide more riverfront access for the citizens. The Tarpon Street Pier has also been refurbished with upgraded facilities and a kayak launch with the same TDC grant funds. Tarpon Street and Riverside Community Center both provide fishing piers open to the public on a twenty-four (24) hour basis. Citizen input at the charrette and follow up meetings was noted. Requests were made for better facilities at the fishing piers, especially for hand washing

and fish cleaning. The lack of such facilities is a hygienic problem and inconvenient for those who are fishing. It was also suggested that a bait-and-tackle shop or a sandwich-shop type concessions would work well for the sites. These would also restore natural surveillance to the pier.

Recreation and Ecotourism

The boat ramp at the Oasis Condominium in the western portion of the study area provides 18 public parking spaces and will be open from dawn to dusk once the project is finished and open to the public. Various attempts have been made to relocate the City's downtown public boat ramp, and although suitable sites have been found, acquisition has been problematic.

Canoe and kayak launches exist in East Fort Myers both along the Creek and Riverfront. Currently, there are three designated launches – Riverside Community Center, Tarpon Street Pier, and Shady Oaks Park on Billy's Creek. Two future launches are proposed along the Creek at the Billy's Creek Condominiums on Palm Beach Boulevard and at the Filter Marsh Park at Marsh Avenue parking lot. In discussions with the Lee County Waterway Coordinator, with all of the sites in existence and planning stages, it appears that there is an adequate amount of launches and spacing for the river and creek frontage.

One additional site was identified during the Charrette process, the isthmus between the Oasis condominium project and Riverside Community Center. This site is owned by the State of Florida and has the potential to be a passive park with river access, a potential stop-off and picnic area for paddlers.

The study area is part of the Great Calusa Blueway Phase III, a nationally designated waterway trail. The current mapping efforts for this trail do not offer the level of detail necessary to implement drop-in points, but rather, they suggest the general area where new facilities should be installed. It was suggested that a detailed map of the East Fort Myers area would be a great idea for ecotourism. Lee County has the existing raw mapping and database of access points, so it was suggested that grant funding be pursued to produce a local map.

Other public access points have been identified in the study area, but these access points are not major ones for the outside public and can be used by local neighborhoods for launching or by visiting (non-local) paddlers for emergency landing purposes. These sites typically do not have any marked parking or access and have been identified in both the City's and County's mapping efforts. A localized



Figure 6.10: Map of Blueway sites in the study area

map from Tarpon Street Pier to New Filter Marsh Park of the blueway already in existence was one great idea from charrette. This could be easily produced with existing GIS and mapping efforts and then printed with grant funds from local agencies.

City and County parks are present in the study area. The facilities report commissioned by the City and completed by Glattig Jackson in 2007 cites the need for additional recreation facilities in the eastern portion of the City, including East Fort Myers.

In the Executive Summary of the *Parks & Recreation Needs Assessment: Final Report - April 10, 2006* by Glatting Jackson Kercher Anglin Lopez Rinehart, Inc., the following issues relative to the study area were cited:

Recommendations:

Bicycle Paths, Trails, Sidewalks and Greenways:

- Develop a City-wide Bikeways, Trails, Sidewalks and Greenways Plan
- Incorporate bike lanes, wide sidewalks and street trees in all street and utility projects

Neighborhood and Community Parks, Playgrounds

- Develop a City-wide Parks and Open Space Master Plan
- Amend the Comprehensive Plan to reflect the Parks and Open Space Vision
- Acquire park land for the eastern developing areas
- Create park design guidelines and maintenance standards
- Institute a joint-use planning process with the County and School District
- Institute a neighborhood and community park impact fee
- Renovate parks in the eastern part of the City to the same standard as parks in the western part of the City.

Boat, Canoe, Kayak Access and Docks

- Include water-access facilities in the City-wide Parks and Open Space Plan
- Develop street-end waterfront parks

Soccer Fields, Complex

- Acquire land for soccer fields/ complex
- Investigate joint planning and development with the County and/or School District

Special Events Area, Amphitheater

- Preserve and expand waterfront parks
- Develop a Waterfront Master Plan

Other Priority Needs

- Evaluate the use of other public properties to meet the needs for an Environmental Education Center

Policy Initiatives:

- Codification of the needs assessment findings in the City's Comprehensive Plan (Recreation and Open Space Element). Specifically, the City's Level Of Service (LOS) should be revised to reflect:
 1. City-wide System basis for calculating acreage Neighborhood and Community parks.
 2. Facility standards consistent with the State of Florida Comprehensive Outdoor Recreation Plan (SCORP).
 3. Service Area and Open Space Criteria consistent with the National Recreation and Park Association (NRPA) standards.
- Revise the City's Land Development Regulations to require the construction of appropriate neighborhood and community parks in new developments.
- Revise the City's Roadway Design Standards to require street trees, bike lanes and/or wide multi-use bicycle/ pedestrian paths on all new/ improved roadways

As far as benchmarking comparisons to other comparably-sized cities in Florida (Delray Beach, Winter Park and Clearwater), the study found that:

- Of the four communities, Fort Myers has the lowest required Level of Service (2 acres/1,000 population vs. 10 acres/ 1,000 population for Winter Park, for example)
- Of the four communities, Fort Myers spends the least for parks construction, maintenance and operations (\$88.64 per capita vs. \$227.91 for Winter Park, for example)
- Of the four communities, Fort Myers has the second lowest Actual Level of Service of park land per capital (10.8 acres/ 1,000 population vs. 13.4 acres/ 1,000 population for Winter Park, for example)

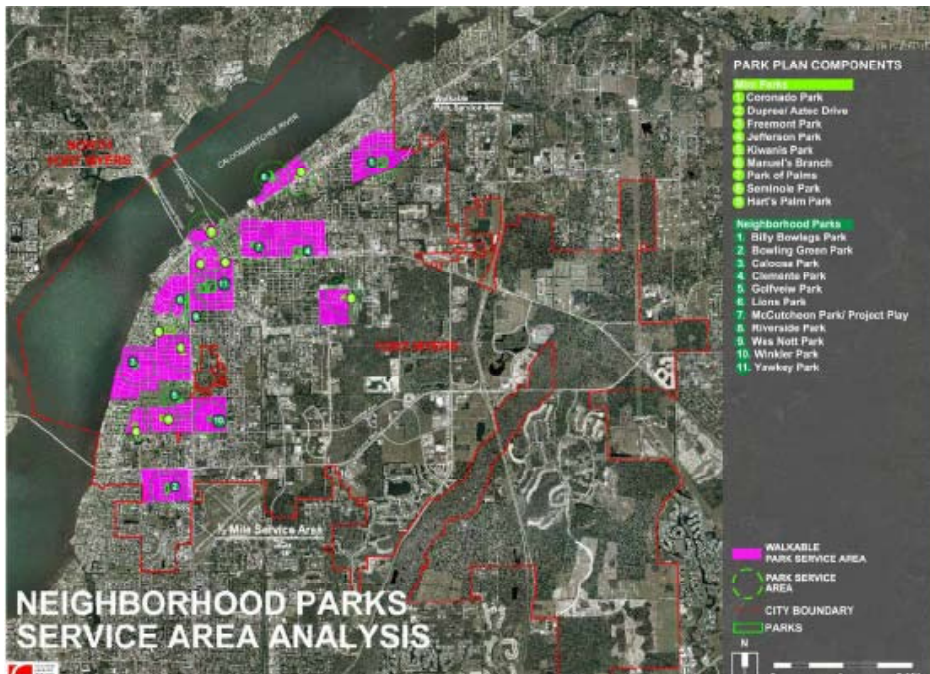

Figure 6.11: Parks & Recreation Needs Assessment: Final Report - April 10, 2006
 Glattig Jackson Kercher Anglin Lopez Rinehart, Inc

The City needs to acquire a minimum of 174 – 214 acres of park land to meet its LOS objectives for the future; ideally the City’s parks system would far exceed this minimum size. As far as particular locations, the Parks & Recreation Needs Assessment: Final Report - April 10, 2006 mapped the neighborhood parks and the walkable radii. This mapping effort shows a lack of neighborhood parks in East Fort Myers.

The report also concluded the following are the top priorities for the City of Fort Myers.

- Bicycle Paths and Trails are clearly the #1 priority in Ft. Myers, followed (in no particular order) by Neighborhood Parks and Playgrounds, Major Special Events Area/ Amphitheater, Teen Center/ Facilities/ Programs and Soccer Complex.

- There is also a need to protect existing public open space, upgrade existing parks, and acquire additional park lands (200+ acres) to meet growing needs. Water access (boat ramps, canoe/kayak, etc) also appears to be a top priority need. A relatively inexpensive an easy way to increase water access for small boats is by retrofitting streets that have dead-ends at the Caloosahatchee River with modest ramps or drop-in points.
- Finally, the disposition of the City’s existing waterfront is a to priority. The downtown waterfront area is the City’s greatest open space asset and serves as the civic gathering space and locus of the community. The area will continue to be more important as the downtown area urbanizes. The opportunity to have a contiguous public open space along the waterfront can have a real influence on the City’s economic, social and environmental sustainability. This area, as well as all of the publicly owned waterfront areas should be enhanced for public access

Greenspace

Many potential greenspace sites were identified in the charrette process. Greenspace can serve multiple purposes in East Fort Myers, especially for public recreation and water quality. Several sites have been identified in this planning process that may serve this dual purpose, as shown on the Illustrative Master Plan (see page 4.4 and 4.5).

Additionally, a search needs to be conducted to identify additional 10-acre (or larger) sites for water quality purposes. Ten acres is generally considered as a minimum acreage to construct any facility that will serve as a water quality benefit.

One new and innovative funding mechanism for new parks is “water quality improvement parks,” or public/private partnerships for greenspace creation. These can be cleverly disguised as soccer or multi-purpose fields with cutting-edge Best Management Practices (BMPs). Also, “stormwater parks,” a combination of stormwater treatment (treatment trains using dry and wet detention, some wetland treatment, and perhaps even some chemical treatment) with passive recreation (walking trails, bridges, and areas for picnicking), are another trend, such as the new Filter Marsh Park on Billy’s Creek. Both of these types of parks have the potential to serve as stormwater and water quality mitigation



Figure 6.12: Proposed Seminole Avenue Park

for redevelopment projects. That is, the redevelopment of the commercial and industrial parcels in East Fort Myers will share the common offsite areas. This is an incentive for the property owner, as the property can be utilized for things other than stormwater retention/detention. This concept has been discussed in Southwest Florida, but to date has not been successfully implemented. Preliminary discussion with local regulatory staff and consultants has been positive and encouraging. This concept may be a good pilot project for East Fort Myers and grant funding would likely be available.

Smaller greenspace parcels, those under ten acres or in remote or inaccessible areas, can also serve a function in the community. One item commonly mentioned in the charrette was the need for community gardens. Almeda Park has already been established via grant funding in the “Garbage to Gardens” program at Academy High through its “Service Learning” program. Other potential sites have been identified in the Illustrative Master Plan for East Fort Myers.



Figure 6.13: The opportunity for community gardens in mid-block locations exists throughout East Fort Myers.

The Garden Council in Fort Myers consists of seventeen Garden Clubs. Preliminary discussion with some of the members who live in the study area shows an interest in adopting potential neighborhood gardens on small parcels. Demonstration projects for “edible gardens” are one area of interest mentioned by the public input.

One key strategic partner, located conveniently within the study area, is the Lee County Terry Park facility, which houses the Institute of Food and Agricultural Sciences and Florida Yards and Neighborhoods programs, as well as the Master Gardener Program, Native Plant Society, and the Rare Fruit Council.

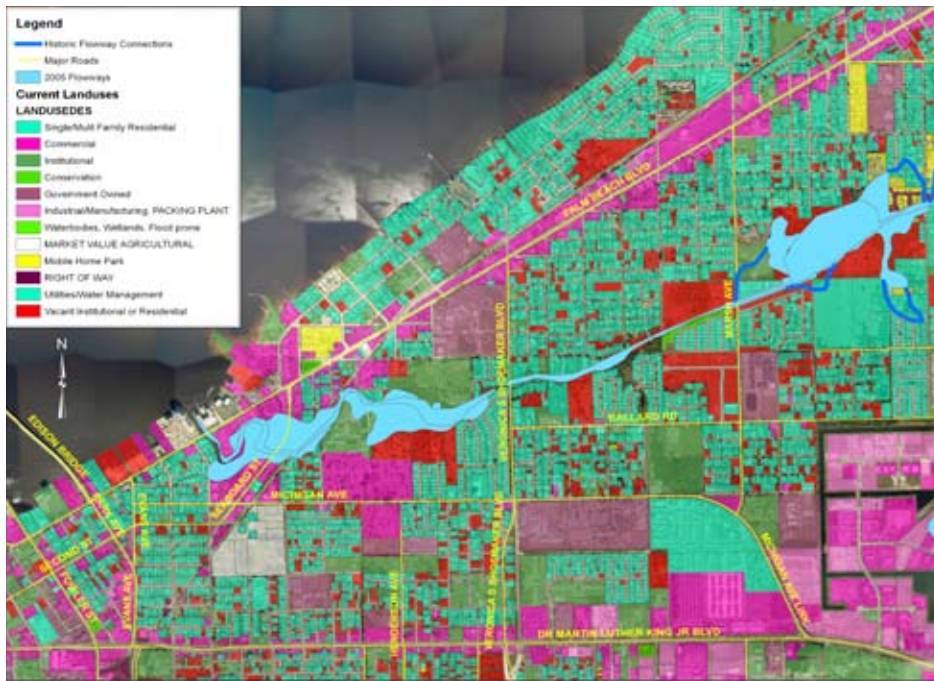

Figure 6.14: Billy's Creek basin: current land uses and flowways

Another priority for East Fort Myers is exotic removal and the restoration of native canopy and understory. The Filter Marsh project is one such example, as the Conservation Land purchase required this as part of the management process. In addition to this exotic removal, the historic flowway will be recreated via the march and ponded areas. The rehydration of historic wetlands in this watershed should be a priority for both water quality and flood control.

Several mechanisms already exist for the purchase of additional greenspace in the study area. The Lee County 2020 program has had additional nominations for its willing-seller program. However, recent policy recommendations will no longer consider properties under forty acres. The City also has an internal surplus lands fund with a bank of lands to buy and sell, with annual updates to the list. The most promising new mechanism is a possible land trust for Billy's Creek watershed. This private land trust would then "bank" lands donated or purchased, and also have a mechanism for conservation easements.



Figure 6.15: Before: Exotic trees threaten the native species



Figure 6.16: After: Removal of the exotics and restoration of the native canopy

Stormwater

Both Billy's Creek and the Caloosahatchee River are verified as Impaired Waters by FDEP. The impairments for Billy's Creek are discussed earlier in this chapter. As of September 2008, the Caloosahatchee River is currently under TMDL process and comment period. New rules and regulations may be implemented as a result within the next ten years, most likely for overall nutrient reduction to the River. In addition, the Caloosahatchee River was listed as one of the top ten "Most Endangered Rivers" by American Rivers for 2005 due to its pollution. Historically, the River has been a habitat for many saltwater species, including tarpon, snook, blue crabs, oysters, and other economically viable fisheries.

Non-point source pollution (NPS) is the largest pollution source in terms of volume in the study area. Watershed planning efforts should include the following priorities:

- Retrofits of older systems
- Stormwater Master Plan recommendations
- Stormwater utility funding for maintenance of existing structures
- Water quality parks for offsite mitigation for redevelopment
- Replacement of septic tanks to sewer or "green" alternatives
- Coordination with green infrastructure to reduce runoff in individual parcels
- Public education of citizens, especially with school-age children

In addition, the City of Fort Myers Waste Water Treatment Plant along Billy's Creek will be upgraded to prevent overflows in storm events. The City is also out of compliance for reuse of this wastewater, and was mandated to provide 100% reuse. This is an ongoing issue with the City, SFWMD, and FDEP and efforts are underway for compliance.



Figure 6.17: Exfiltration tank



Figure 6.18: Drainage swale planted with natives

The City is already in the process of exploring a solar thermal utility for providing heated water to customers via roof units that would be funded by the City for a monthly fee.

Green Infrastructure

Healthy watersheds fit into the entire green infrastructure as proposed for East Fort Myers. Some of the major functions of both watersheds are:

- Healthy riparian areas
- Connected habitats and riparian areas
- Ability of waterways to respond to flood events
- Ability of watershed to absorb/react/respond to nutrient/pollutant inputs
- Ability of watershed to respond to inputs from changing impervious surfaces

Green infrastructure uses trees and other vegetation in urban areas to manage and treat precipitation naturally rather than collecting it in pipes. It uses engineered systems such as green roofs, rain gardens, and vegetated swales to mimic natural functions. Green infrastructure often accompanies approaches that capture and re-use stormwater and wastewater.

The overall economic benefits are worth the effort and initial investment, as green infrastructure will save the City on energy costs and future capital improvement projects. In addition, other benefits of green infrastructure, that may be realized in East Fort Myers, include:

- Captures sewer overflows
- Filters polluted stormwater
- Recharges groundwater
- Reduces heat island effect
- Improves air quality
- Provides wildlife habitat and recreational space
- Protects stream banks
- Conserves energy
- Prevents flooding
- Improves urban aesthetics
- Increases property values
- Often less expensive than conventional approaches, especially operations and maintenance

Water barrels, cisterns, and exfiltration tanks are just some of the green infrastructure tools that can be applied in East Fort Myers.

Funding Mechanisms

Government funds are available for a variety of environmental projects on a variety of levels for the study area. The City of Fort Myers recently fully-funded a Stormwater Utility Tax; in fact, the City Council recently doubled the proposed stormwater fee to advance the needed projects and accelerate the design, permitting, and construction schedule.

- Lee County Division of County Lands Conservation 2020 Program has supported the efforts of the City of Fort Myers to purchase land along Billy's Creek with the recent approval of \$2.4 million for the Filter Marsh site. This was the largest purchase for this program within an urban area. Department of Natural Resources is currently providing in-kind technical assistance via its TMDL Program and assisting with GIS and mapping, as approximately half of the Billy's Creek Watershed lies outside the City limits in unincorporated Lee County. Lee County also holds the overall EPA Stormwater Permit for the stormwater system (MS4) and offers oversight on many issues.

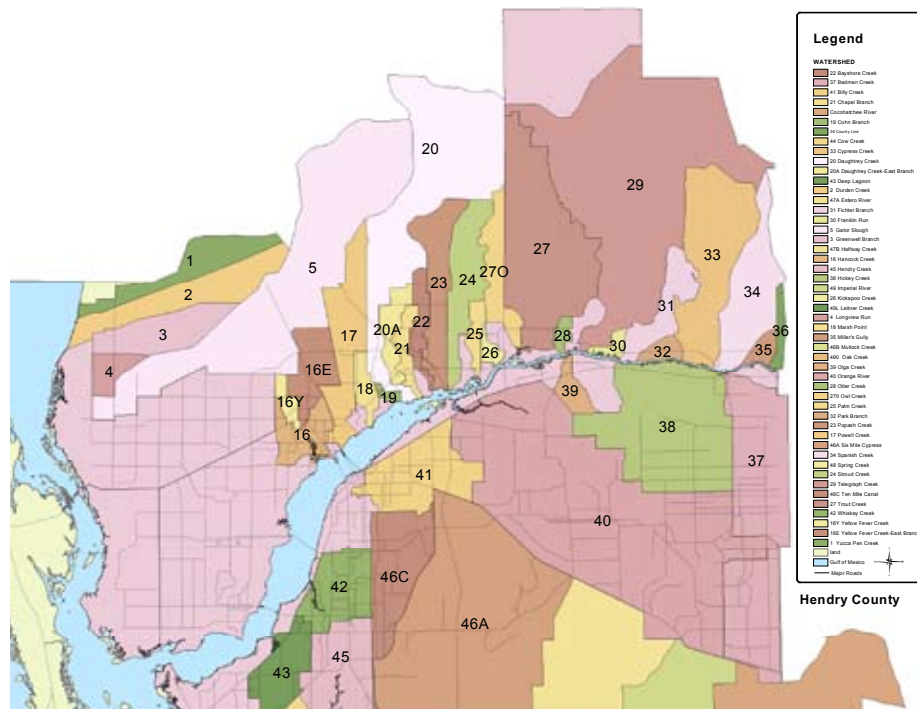

Figure 6.19: Lee County watersheds

- SFWMD provides direct funding via Northern Everglades Program, the Caloosahatchee River Watershed Protection plan, and other efforts. The Southwest Florida Feasibility Study (SWFFS) process is ongoing as part of the Comprehensive Everglades Restoration Plan (CERP) for Federal funding for the Caloosahatchee River. No projects have been identified in the study area, though other projects may benefit the area due to reduced flows and pollution.
- FDEP provides a variety of potential funding for wastewater, stormwater and other priorities. Many are pass-through funds, such as EPA 319 grant funds for stormwater projects. Additionally the US EPA provides Brownfields Loans and Grants to Restore Watersheds, Center for Watershed Protection grants for technical assistance, and the CARES Grant for watershed education.
- Since the study area is also part of Charlotte Harbor National Estuary Program (CHNEP), funds are available for a variety of watershed education and research projects. This organization also offers technical assistance and grant-writing assistance.



Figure 6.20: Billy's Creek Filter Marsh sign



- The School Board of Lee County has an award-winning Environmental Education program with dedicated staff to work on cooperative educational projects. There are many opportunities to team with the schools for watershed education and green infrastructure.
- Private funding sources via foundations are one area worth exploring further, as the demographics and the economic factors in East Fort Myers are potential matches for funders. Partnerships with non-profits, such as the Boys and Girls Club and the Friends of Billy's Creek, may also bring additional grant funding to East Fort Myers.



Figures 6.21-26: Meet the Creek activities

References:
 Lee County Trails and Greenways Master Plan
 City of Fort Myers Stormwater Master Plan (ECT, 2008)
 City of Fort Myers Citywide Parks and Recreational Needs Assessment

WHAT IS SUSTAINABLE DESIGN?

"The linked domains of sustainability are environmental (natural patterns and flows), economic (financial patterns and equity), and social (human, cultural, and spiritual). Sustainable design is a collaborative process that involves thinking ecologically—studying systems, relationships, and interactions—in order to design in ways that remove rather than contribute stress from systems. The sustainable design process holistically and creatively connects land use and design at the regional level and addresses community design and mobility; site ecology and water use; place-based energy generation, performance, and security; materials and construction; light and air; bio-climatic design; and issues of long life and loose fit. True sustainable design is beautiful, humane, socially appropriate, and restorative."

AIA Committee on the Environment, Definition of Sustainable Design, 2007



Make neighborhoods 'walkable,' 'bikeable,' and 'boatable'

In order to make neighborhoods more walkable, sidewalks should be added along most streets in East Fort Myers. Every effort should be made to eliminate dead-end streets, which tend to have a problem with natural surveillance. Increasing the number of through streets will also decrease the size of some blocks, giving pedestrians more direct routes to arrive at their destinations. Shade should be added to streets, either by planting shade trees or, in commercial areas, making sure that buildings have awnings, colonnades, or other devices

to shelter the pedestrians. Redesigning the streets to increase pedestrian comfort will also benefit the cyclists. "Sharrows", lanes that are marked for cyclists yet shared by drivers, are preferred over conventionally-sized bike lanes because they do not increase the amount of asphalt width as conventional bike lanes sometimes do. Every block should provide a bike rack. East Fort Myers has many opportunities for boat travel, from larger boats to small kayaks and canoes. The Caloosahatchee River is part of the Great Calusa Blueway, a 190 mile canoe and kayak trail that runs along the northern edge of East Fort Myers. This waterway, along with Billy's Creek, provides many opportunities for boat travel.



Use renewable and locally-generated energy

As nonrenewable fossil fuels become depleted, they tend to become more expensive. Each neighborhood can do its part in reducing greenhouse gas emissions by using renewable energy, especially renewable energy generated on-site. Solar water heaters, photo-voltaic panels and solar cookers are some of the many ways that residents and business owners can harness the sun's power.



Promote transit and transit-ready development

As cars become more costly to operate, railways and other forms of transit will have increasing relevance in our daily lives. East Fort Myers is blessed with an active railway, which could be turned into a passenger rail corridor. Every effort should be made to reduce the waiting time between time for buses along Palm Beach Boulevard. Dignified, comfortable shelters should be installed. Mixed-use, dense development should be planned in the vicinity of existing or future transit stops. New development should be built with reduced parking ratios in order to discourage automobile trips and favor transit use.



Promote locally-grown, organic food

Food purchased at supermarkets is often trucked or flown in from other states and even other countries. The great reliance on fuel-intensive long-range transport of food is unlikely to be sustainable. Also, such food products are often genetically modified and are laden with antibiotics and petroleum-based pesticides and fertilizers, all of which have deleterious effects on human health. Community Supported Agriculture (CSA) is a way that residents can receive seasonal, organic, and local food products if they are unable to grow them in their own gardens. Additionally, there are many vacant lots and plots of

ground within East Fort Myers that could be transformed into fruit and vegetable gardens in order to provide a year-round source of inexpensive produce for residents. Growing food locally is healthier for the soil, for the atmosphere, and for the human body.



Slow and capture rainwater

A wide range of devices and landscapes should be installed throughout East Fort Myers in order to slow and capture precious rainwater. Rain barrels and cisterns can be added to buildings, providing a source of irrigation water during the dry season. Bio-swales use aquatic plants and plants that thrive in high moisture to slow down and treat runoff. Reducing impervious surfaces by replacing conventional asphalt in driveways and parking lots with pervious pavement, bricks, gravel, or crushed shells will help recharge the aquifer.



Restore native habitats

Many of the open spaces in East Fort Myers are infested with invasive exotic species, such as Australian Pines, Brazilian Pepper, and Australian Maleleuca. The proliferation of exotic trees is a threat to biodiversity - not only of the native trees that they supplant, but also of the native birds, mammals, and insects that depend on native trees for habitat and sustenance. Recent eradication of exotic species, along with replanting of native trees, has been successful at Billy Bowlegs Park. Similar programs should be carried out along Billy's Creek and other green spaces in the area.



Promote physical activity by improving access to green space & natural areas

Increased physical activity goes hand in hand with lower automobile usage. Each resident should have a park or public green space within walking distance of home. Increase access points to existing parks and natural areas, and increase the variety and number of sports fields in the community.



Reduce, reuse, recycle

Reduce: Cut down on the resources that we use. Take canvas bags to the shops rather than accepting plastic bags in the check-out line. Shun water bottles and excessively-packaged items. **Reuse,** fix, and clean furniture, appliances, and clothing rather than discarding them. Buy second-hand and vintage furniture, art, and clothing rather than brand new items. Give unwanted items to charitable institutions such as Goodwill and Salvation Army. **Separate** recyclable waste such as aluminum, glass, paper, and plastics from the rest of the household's waste. Place these items in the appropriate bins. Compost all organic material, such as a vegetable scraps, and use it as organic fertilizer for the garden.



Build and retrofit structures to be energy-efficient

Replace incandescent bulbs with compact fluorescent bulbs. Chose energy star appliances over wasteful models. Use ceiling fans and cross-ventilation instead of air conditioning on days that the humidity and temperature levels are comfortable. Replace inefficient air conditioning systems with efficient ones. Install low-flow shower heads and faucets. Make sure that windows are sealed and doors have weather strips. Install sufficient insulation in attics and walls. Unplug electric appliances that are not in use. Plant shade trees around structures in order to lower cooling bills. Consult U.S. Green Building Council for many more suggestions.



Educate the community, especially the children

Involve children in tree planting and recycling programs. Explain why such activities are so important for their future. Teach them how to grow their own food. Introduce them to the wild nature that exists in their own back yards. Take them to historical sites. Instill in them a sense pride in East Fort Myers and a sense of wonder for the environment and its fragility.

ACTION STEP # 8

RESTORE THE NATIVE LANDSCAPE ALONG BILLY'S CREEK

Expose native plants such as Cabbage Palms (*Sabal palmetto*).

Plant mangroves and other native aquatic plants once Brazilian Peppers (*Schinus terebinthifolius*) have been removed.

Clean litter from mangrove roots on a monthly basis.



Remove Australian Pines (*Casuarina equisetifolia*). They are harmful to the landscape because they compete with native plants for nutrients and light. They inhibit biodiversity of the forest floor by inhibiting the growth of understory plants. Australian pines degrade habitat and are useless to native animals.

Construct boardwalks along some stretches of Billy's Creek and at least one wooden bridge to link Shady Oaks Park on the north side of Billy's Creek to Fort Myers Cemetery on the south side.



Once the native coastal forest has been successfully restored, City Officials and residents must continue to maintain this fragile ecosystem. Regular removal of pest plants and a monthly cleanup of litter in the mangrove forests are essential to the health of Billy's Creek. There are many benefits to keeping the mangrove roots clear of rubbish. Such cleaning efforts help the food chain of the Caloosahatchee River and the Gulf of Mexico, which begins in the roots of these and similar mangrove forests. Healthy roots contribute to a healthy fishing industry and local economy. Also, ecotourism will only be possible if a pristine coastal habitat is maintained.

GLOBAL CLIMATE CHANGE, SEA LEVEL RISE, AND EAST FORT MYERS

Planning for climate change and sea level rise is becoming an essential and standard element in local land use policy documents, especially in low-lying Floridian cities. There is consensus among scientists that global climate change is real, it is man-made, and it will cause irreversible change to our planet in the coming years. Decades of manufacturing pollution, deforestation, and the burning of fossil fuels to run our cars, power plants, and homes, have produced more greenhouse gasses than could be absorbed by the world's oceans, grasslands, and forests.

Though manmade greenhouse gasses have been warming the earth since the beginning of the industrial revolution, the rate of emissions has increased dramatically in recent decades. During the last few years we have passed the unheard-of level of 385 parts per million of atmospheric carbon dioxide (CO²). This has resulted in the warming of the earth's surface, which has in turn started the process of sea level rise. Sea level rise is the result of two mechanisms: thermal expansion of the oceans and melting of land ice sheets. Combined, they have already contributed to almost a foot of sea level rise in the last hundred years. Because of the rapidly increasing temperatures due to the increasing output of greenhouse gasses, we can expect an average rise in global temperatures between 2.5 and 10.4 degrees Fahrenheit in the next hundred years. The accompanying sea level rise will likely be between one and five feet, and potentially more, considering that this does not factor in the disappearance of polar land ice, which is already starting to melt at an alarming rate.

What does this mean for East Fort Myers? As the map illustrates, the first properties that will be affected (with a sea level rise of five feet) are those along the Caloosahatchee River and those along Billy's Creek. These are colored pink. Because the land around Billy's Creek has a much more gradual slope, the risk is even greater for properties near the mouth of the Creek than for those along the River. With a sea level rise of five to ten feet, greater portions of the study area will be affected. These are colored yellow. This suggests that property will become even more vulnerable to storm surges caused by tropical storms and hurricanes, which are likely to increase in frequency and intensity given the warming of the surface temperatures of the North Atlantic Ocean, Caribbean Sea, and Gulf of Mexico. While the shallow, hot waters of the Gulf of Mexico are the origin of many storms that affect Southwest Florida, the Caribbean Sea and North Atlantic give rise to many storms that curve north and then westward over this part of Florida.

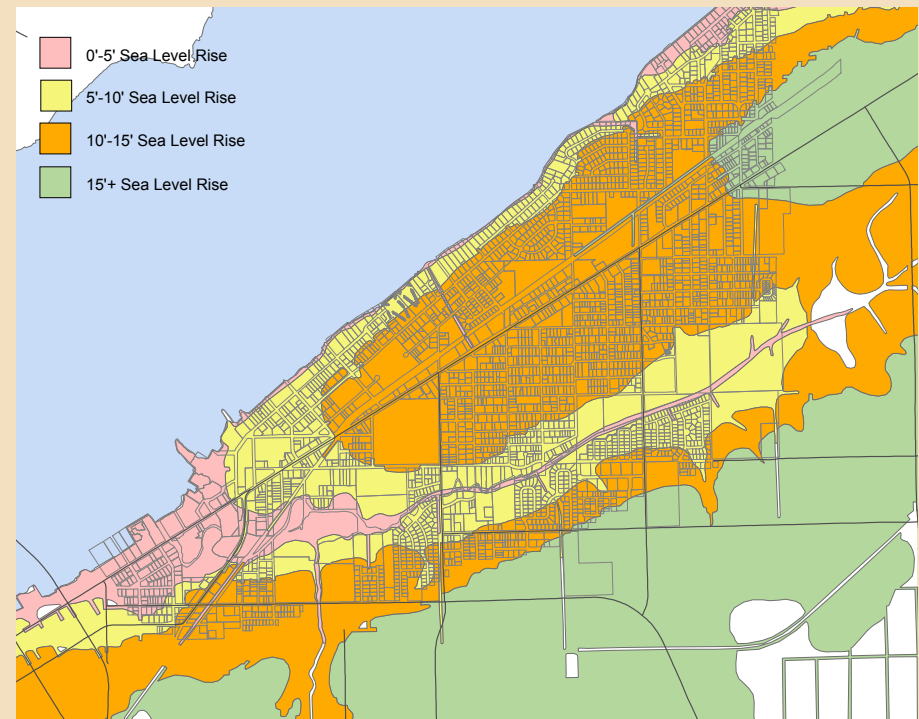

Map of parcels that will be affected by differing projections of sea level rise

What can be done? In the short term, it is essential that the natural land-building processes be nurtured by restoring the mangrove forests and other coastal plant communities along the entire length of the Caloosahatchee River and Billy's Creek. This will allow for the crucial processes by which roots trap sediments and decaying organic matter. This results in expansion and strengthening of the coastline and its ability to resist erosion. In addition to adding fill to low-lying coastal properties, seawalls and beaches should be replaced by native plant communities, which are often more resilient and adaptable than the artificial landscape which predominates along most of the creek and river.

Any new development in the areas should be scrutinized for its adaptability to a rising sea. For instance, whenever possible, the mean grade of properties should be raised each time they are redeveloped. In order to prevent loss of valuable real estate, this will entail the eventual coordinated raising up of infrastructure such as streets and sewers from their present levels.

Also, East Fort Myers and the rest of Fort Myers will have to secure a water source that is not easily contaminated by salt water intrusion, which will only worsen as hydrostatic pressure increases between the salty Gulf of Mexico and the fresh water of Florida's aquifers. It is possible that large scale desalinization plants will be necessary in the future. *Prospects for Southeast Lee County, Planning for the Density Reduction/Groundwater Resource Area (DR/GR)* illuminates the need for planning to protect groundwater supply from alterations of the hydrology of this part of Southwest Florida. Planning decisions both inside and outside Fort Myers will affect the livability of this community and the entire metropolitan region. On a smaller scale, the capture and storage of rainwater through rain barrels and cisterns will also become more important as drinking water is threatened by salt water intrusion and droughts that occur due to disrupted rain cycles. The early pioneers of Florida had perfected devices for the capture and storage of rainwater more than one hundred years ago, and such technology will likely have to be resurrected in the near future.

Vernacular building types in Florida unfailingly incorporated raised-finished ground floors. In hurricane-prone areas, the raised finished floor was usually high – more than three feet and sometimes as high as one storey. Raising houses on blocks, piers, or pilings not only allowed the roots of vegetation and plants to grow under structures, but also improved drainage by reducing

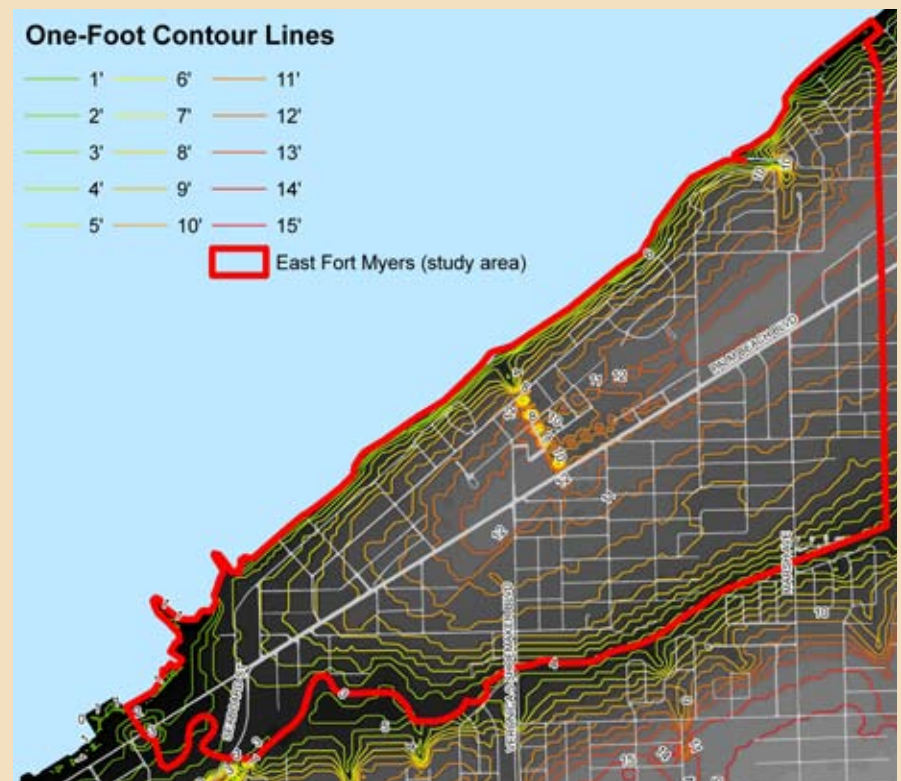

Approximate elevations of land in East Fort Myers (above mean sea level)

impervious surfaces. Such houses had improved air circulation, and were considered comfortable (oriented to catch prevailing breezes and shaded by the canopies of the large trees around them) even before the invention of air conditioning. Above all, such houses were less vulnerable to storm surges.

As the map illustrates, the founders of this settlement wisely located its most valuable infrastructure, the railroad and the main street, Palm Beach Boulevard, at the centerline of the ridge, so that it was least vulnerable to flooding. The issue of sea level rise will have to figure into all future decisions regarding the development of coastal communities like East Fort Myers.



implementation 7

KEY IMPLEMENTATION STEPS

Throughout this document, specific action steps indicate how the city can carry out major recommendations of this plan. Each action step is highlighted with a green box.

The first three action steps are found in Chapter 4 (Four-point Strategy);

#1: Public access along the river - Page 4.9

#2: Seminole Avenue park

#3: Plant street trees

The next four action steps are found in Chapter 5 (Transportation):

#4: Palm Beach Boulevard medians

#5: City leaders should lead Lee County in supporting better public transportation.

#6: Complete the street network

#7: Complete the pedestrian network

Another action step is found in Chapter 6 (Environment):

#8: Restore the native landscape along Billy's Creek

Eleven additional action steps are covered in this final chapter, based on discussions of the following topics:

Regulatory Framework for Revitalizing East Fort Myers — Pages 7.4–7.7

East Fort Myers is bounded by two bodies of water that have high ecological, aesthetic, and recreational values. The Caloosahatchee River and Billy's Creek add obvious value to adjacent properties and can also add value to all of East Fort Myers if steps are taken to make the waterfront visible and accessible to all. While these features are important assets, they can complicate redevelopment because of special regulatory constraints, including federal floodplain regulations as well as state and city coastal regulations.

Former “Waterfront Development Districts” — Page 7.8

This section describes regulations that were previously associated with riverfront parcels from Billy's Creek to Tarpon Street. These regulations did not adequately establish the form of new buildings, allowing unlimited height on some parcels and heights on others that were incongruous with the density cap.

Interim Development Approval Process — Page 7.9

An interim development approval process has been in effect since 2006 to allow the city to create new plans and development standards for East Fort Myers. This report augments the previous planning efforts and will lead to new regulations that will replace the interim development approval process.

Current Comprehensive Plan and Zoning Maps — Pages 7.10–7.11

Fort Myers is transitioning to a two-map system of regulating development. Because the Comprehensive Plan's Future Land Use Map is relatively difficult to amend (compared to the Land Development Code's zoning map), a two-map system will allow routine zoning decisions to be made by City Council without the need to repeatedly amend the Comprehensive Plan.

East Fort Myers Transect Map — Pages 7.12–7.13

Currently, the Future Land Use Map and zoning map suggest an undifferentiated and homogenous ribbon of similar uses, intensity, and building form along Palm Beach Boulevard. Vibrant cities have frequent nodes of higher-intensity uses surrounded by quieter residential neighborhoods. By identifying future development patterns for East Fort Myers using an urban-to-rural transect, healthy mixed-use environments can be created at varying levels of intensity instead of an undifferentiated ribbon. This approach also allows the inclusion of a wider variety of building types in neighborhoods adjacent to the corridor's more intense nodes or centers.

Proposed Comprehensive Plan “Future Land Use Map” — Pages 7.14–7.15

The proposed Future Land Use Map for East Fort Myers incorporates the same zones illustrated in the transect map but is presented here in a format that can be used throughout the City of Fort Myers for the new Future Land Use Map.

Comprehensive Plan “Future Land Use Element” — Page 7.16-7.17

Two new designations are proposed here to implement the new mapped designations: “Suburban Center” and “Suburban General.” These would replace the current B-1 and B-2 designations and would identify potential future extensions of commercial and mixed-use development away from Palm Beach Boulevard.

Regulatory Caps on Building Bulk — Page 7.17

This section proposes the elimination of current rules that unnecessarily limit the “floor-to-area ratio” to 1.0 and that limit building coverage to 60% of the site for certain zones.

Ensuring Better Development Patterns — Pages 7.18–7.20

This section describes different types of land development regulations that could carry out the recommendations in this report. Once the city decides which approach to follow, the detailed regulations would have to be drafted, refined, and adopted by the City Council.

City Policy Toward Neighborhood Plans — Page 7.23

The Comprehensive Plan needs to be adjusted in order to make neighborhood plans, both their boundaries and identities, more understandable.

Expanded Enterprise Zone — Page 7.24

The Enterprise Zone and Southwest Florida Enterprise Center are not being tapped to their full potential by businesses and aspiring business owners. These programs would benefit from more marketing so they can play a greater role in the revitalization of East Fort Myers.

East Fort Myers from the CRA Perspective — Pages 7.25–7.28

A CRA plan does not automatically override either the Comprehensive Plan or the Land Development Code but should be considered when amending both documents and when the city makes discretionary decisions such as rezonings. There are many recommendations in the East Fort Myers Revitalization and Redevelopment Plan for specific changes to both the

Comprehensive Plan and the Land Development Code; later public hearings are required to formally change those documents to implement parts of this plan.

Supplementary Funding for Bicycle Patrols — Pages 7.29

Other redevelopment districts in Fort Myers fund a roving bike patrol to enhance police protection. When funds are available, the East Fort Myers redevelopment area should participated in this bike patrol program as well.

Housing and Economic Recovery Act of 2008 — Page 7.30

In 2009 Fort Myers will receive \$2.3 million in emergency assistance under this recent federal law. These funds must be applied to areas with concentrations of abandoned and foreclosed residential structures and must benefit those of modest means. East Fort Myers qualifies on both counts and should be one of the focus areas for these funds.

Recommended Funding Priorities

Some of the action steps can be accomplished fairly quickly and with minimal expenditure of city funds. Others will take longer to accomplish and will require city funds that may not currently be available or grants from other agencies. This plan’s major recommendations have been summarized on Page 7.31 and a preliminary prioritization has been suggested. City officials should refine this prioritization, assign responsibility for individual steps to appropriate departments, and regularly measure the city’s progress on the high-priority recommendations.

REGULATORY FRAMEWORK FOR REVITALIZING EAST FORT MYERS

East Fort Myers is fortunate to have a prime location between the Caloosahatchee River and Billy's Creek, yet this location brings with it several regulations with the potential to complicate the revitalization process.

Federal Floodplain Regulations

As a condition of making flood insurance available to property owners, the federal government requires the City of Fort Myers to set special construction standards on all land within what it determines is the "100-year floodplain" (land with a 1% chance of being flooded each year).

All floodplains in Lee County were recently re-mapped by the federal government for the first time since the early 1980s when the original maps were prepared. As required by federal law, these new maps have been adopted by the city of Fort Myers and became effective on August 28, 2008.¹ Figure 7.1, shown on the following page, summarizes the new boundaries on an aerial photograph of East Fort Myers.

In East Fort Myers there are three high-risk regulatory zones within the floodplain, known technically as "special flood hazard areas":

- The least restrictive regulatory zone is known as the "AE" zone, which is shown in pale yellow. Computer models anticipate coastal flooding in this zone at various elevations above sea level, as shown on the map. Mortgage lenders require the purchase of flood insurance in AE zones, and new or "substantially improved" structures must have their lowest occupiable floor elevated at least this high. The only exception is that the city may allow commercial space to be constructed below this elevation if the space is structurally protected from flooding; this process is known as "dry floodproofing."
- A more restrictive zone is known as the "VE" (velocity) zone, which is shown in lavender on the map. In this zone, wave action from the river is expected on top of rising coastal floodwaters. New or "substantially improved" structures must have all floors and horizontal beams elevated 10 feet or more above sea level in East Fort Myers, and there is no possibility of commercial space below this elevation. Mortgage lenders will require the purchase of flood insurance. Although this zone is extremely restrictive, it applies to so little land in East Fort Myers that it will have an insignificant effect on the revitalization process.

¹ These new maps calculate the distance above "sea level" differently than the old maps. The new maps are based on the number of feet about a theoretical "sea level" known as NAVD 88. The previous maps were based on an older sea-level standard known as NGVD 29, which in Lee County is about 1.18 feet higher than NAVD 88.

- A new overlay zone is called the "floodway," shown on the map with black hatching along Billy's Creek. Unlike coastal flooding zones where waters rise as water is driven up the Caloosahatchee by tropical storms or hurricanes, a floodway is the area along creeks where flooding may occur as rainwater overtops the banks of the creek. Prior to these changes, floodways had never been designated anywhere in Lee County; now 19 square miles of floodways have been mapped. New restrictions now apply to all construction, including the placement of fill dirt. Anyone wishing to build in a floodway must demonstrate there will be no effect on flood waters.

Much of East Fort Myers is considered at low-to-moderate risk for flooding and therefore lies outside the "special flood hazard area":

- A zone shown in pale pink has been mapped to indicate the area that would have been in the AE zone if the statistical standard had been 0.2% chance of flooding every 100 years instead of a 1.0% chance. This zone has no legal significance unless the city were to decide to impose restrictions beyond those required by the federal government.
- This and the remaining area not shaded on the map are formally designated as an "X" zone on the floodplain maps, indicating that these areas are high enough that serious flooding is unlikely. No special flood hazard regulations apply to land in an "X" zone. Flood insurance is available but lenders do not require its purchase.

These new maps may have a significant affect on development and redevelopment of land in the new floodway along Billy's Creek. The impacts of the other zones will be relatively minor, requiring slightly elevated buildings not otherwise affecting the use of land or its redevelopment potential.

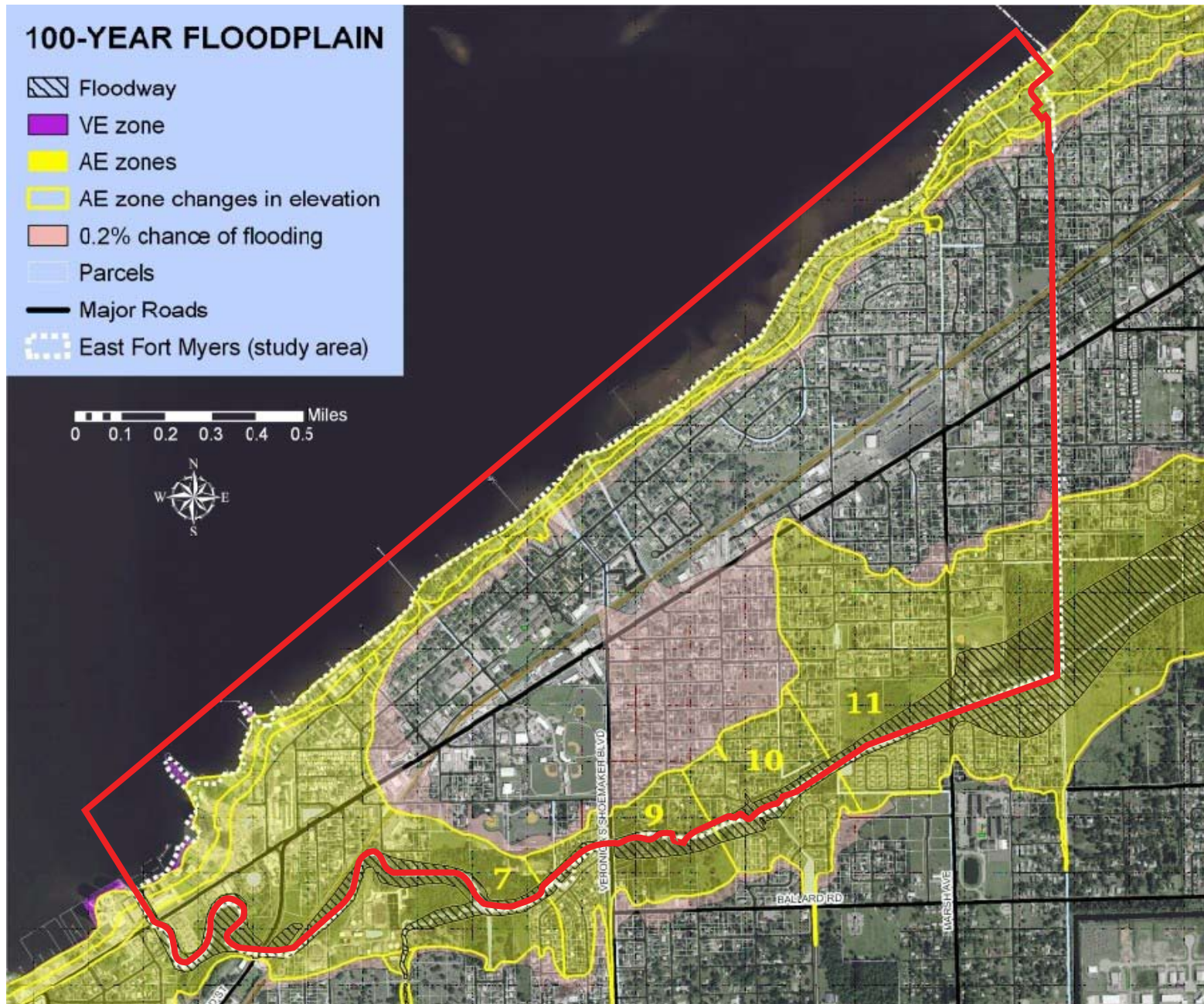

Figure 7.1: 100-year Floodplain Map for East Fort Myers, updated in 2008.

State and City Coastal Regulations

The City of Fort Myers Comprehensive Plan contains certain coastal regulations that apply in addition to the federally-mandated flooding requirements that were described in the previous section. These additional requirements have origins in state mandates; the state has authority to accept or reject comprehensive plans adopted by cities and counties.

Figure 7.2 on page 7.7 shows the current coastal boundaries as mapped in the Fort Myers Comprehensive Plan: the Coastal High Hazard Area (CHHA, from Map L-2) and the Coastal Zone (from Map K).

The CHHA is defined and regulated by the Comprehensive Plan as follows:

OBJECTIVE 9 – Designate a Coastal High Hazard Area (CHHA).
[*Conservation & Coastal Management*]

Policy 9.1) The City has designated a Coastal High Hazard Area that includes all area below the elevation of category 1 storm surge line as established by a Sea, Lake and Overland Surges from Hurricane (SLOSH) computerized storm surge model as established by the Southwest Florida Regional Planning Council and demonstrated on Map L-2.

Action 9.1.1) Limit public expenditures that subsidize development permitted in the Coastal High Hazard Area except for restoration or enhancement of natural resources.

Standard 9.1.1.1) Critical facilities including sewage treatment plants, electrical power plants, police and fire protection facilities, hospitals, housing for special needs groups (including elderly, physically and mentally handicapped, and any other at-risk needs group), and shelters shall be located outside the Coastal High Hazard Area.

Standard 9.1.1.2) Amend or maintain the Future Land Use Map to decrease or maintain permitted residential densities within the Coastal High Hazard Area located outside the Downtown Redevelopment Area.

Action 9.1.2) In order to help control growth in the Coastal High Hazard Area, the City shall prohibit the use of tax increment financing incentives to promote development within the CHHA, unless the project in question involves a joint public/private partnership.

Action 5.4.6) The City will ensure that public expenditures within the Coastal High Hazard Area are limited to those expenditures to maintain existing public facilities, make such facilities more disaster-resistant, provide or maintain public shoreline access, and restore and protect natural systems.
[*Future Land Use*]

Standard 5.4.6.1) The City will eliminate tax increment incentives for development within the Coastal High Hazard Area.

Standard 5.4.8.2) The City shall increase public access to the Caloosahatchee River by requiring new developments along the river shoreline to provide such access.

For purposes of East Fort Myers revitalization, the relevant language for land in the CHHA is underlined. Residential density increases within the CHHA are explicitly forbidden. Tax-increment financing incentives such as property tax rebates are no longer allowed for private development, although they may still be considered for public/private partnerships.

Some of these requirements were added to the Comprehensive Plan in December 2003 to assure the state of Florida that the riverfront density increases for downtown Fort Myers would not be the basis for similar increases beyond downtown. These requirements are quite strict; they apply to all land that is shown as CHHA on this map. The new requirements took effect in March 2004

Standard 9.1.1.2) was amended at that time to apply only outside the downtown redevelopment area (which runs from the Royal Palm Yacht Club at the end of West First Street to Billy's Creek). New regulations were applied just to the CHHA inside the downtown redevelopment area – most importantly, a cap of 2,352 residential units (in Action 5.2.2). No comparable cap in residential units applies to East Fort Myers.

Older policies in the Comprehensive Plan identified a “Coastal Zone” which extends up Billy's Creek and also runs along the south bank of the Caloosahatchee. This Coastal Zone includes more land than the CHHA.

Action 7.3.1 of the same Comprehensive Plan element states:

Action 7.3.1) For areas within the Coastal Zone, which are located outside the boundaries of the Downtown Redevelopment Area, the Future Land Use Map shall designate low-density residential as the preferred use.

The meaning of Action 7.3.1) is imprecise; the term “preferred use” is not defined nor used anywhere else in the Comprehensive Plan. The Future Land Use Map and the new zoning map list “permitted uses” which are allowed by right at the landowners' discretion; how the plan intends one of these permitted uses to be encouraged as “the preferred use” is not self evident. Action 7.3.1) is relevant at least during discussions of rezoning or comprehensive plan amendment requests if lower-density land is being proposed for higher densities.

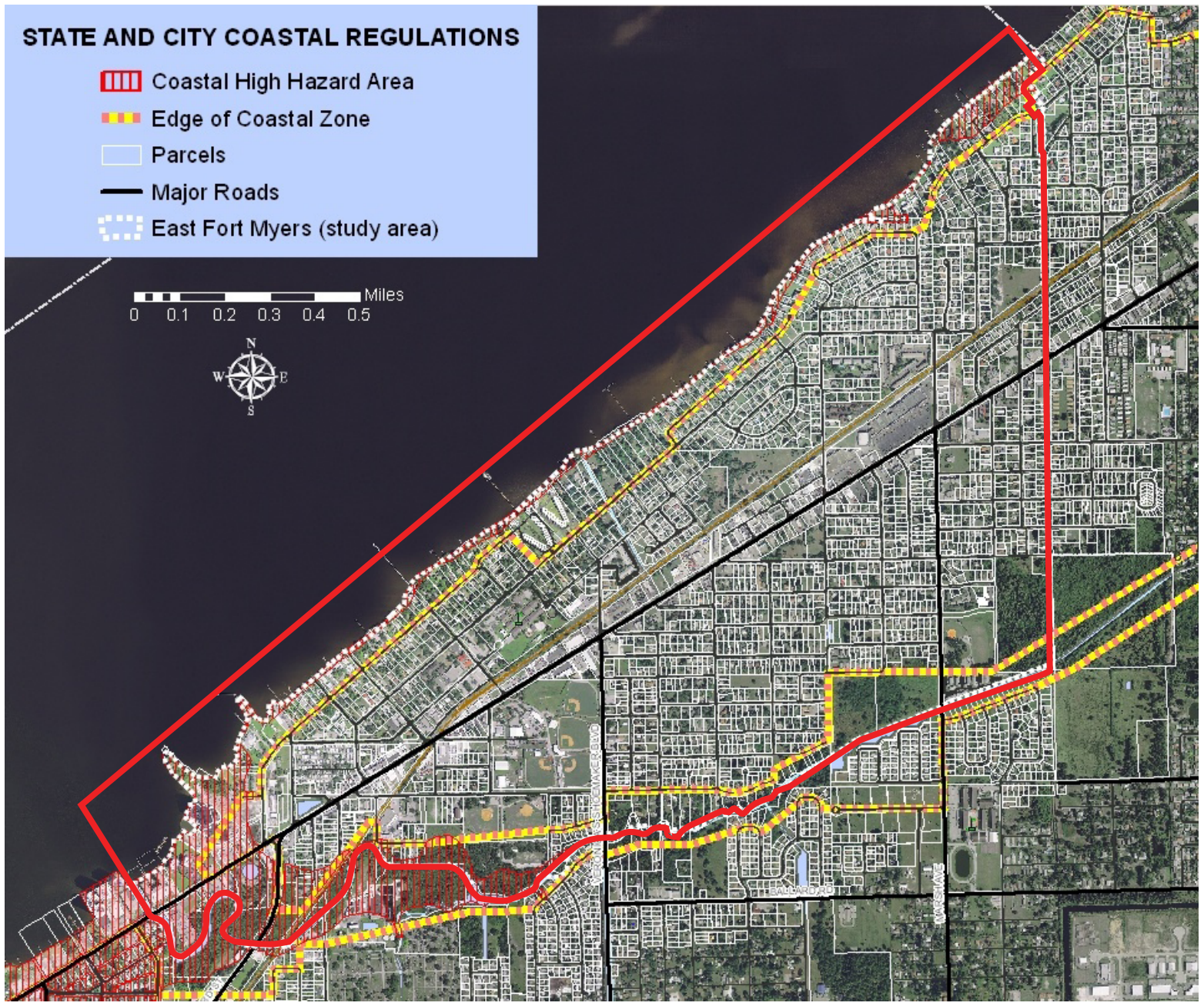

Figure 7.2: Coastal High Hazard Areas and Coastal Zones in East Fort Myers, as designated in the Fort Myers Comprehensive Plan.

FORMER “WATERFRONT DEVELOPMENT DISTRICTS”

Public discussions about development in East Fort Myers often refer to former designations known as WDD (“Waterfront Development Districts”). These used to serve as zoning districts as well as districts on the “Future Land Use” Map on land near the river from the western end of downtown to just east of Tarpon Street. These designations are shown here as they had been applied to parts of East Fort Myers.

In December 2003, these districts were removed from the Comprehensive Plan. West of Billy’s Creek, they were replaced by new districts that implemented the downtown “SmartCode.” East of Billy’s Creek they were replaced by conventional districts as discussed in Chapter 7; the prior WDD-1 and WDD-2 districts were converted to B-1 and the WDD-3 district was converted to A-3.

Table 7.1 identifies the purpose and major regulatory standards that applied to each of the three WDD districts.

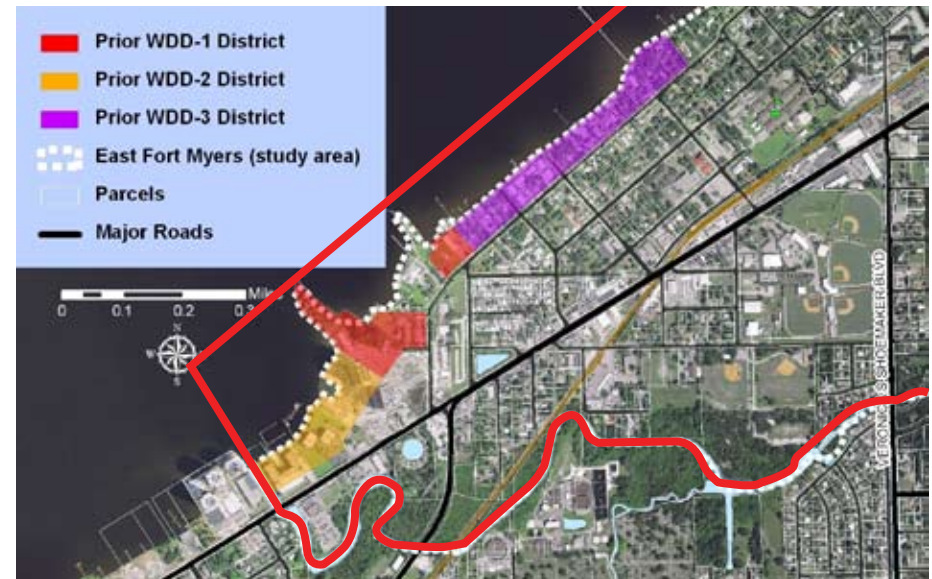

Table 7.1

(from former) COMPREHENSIVE PLAN Description	Density	Height	Building/ Lot Coverage
WDD-1 Standard 2.9.2.1) Waterfront Development District One areas shall be designated for water-enhanced uses, such as: high-density, high-rise residential, hotels and motels, restaurants, retail stores, bars, convention centers, museums, plazas, public walkways, docks, and private clubs.	25 (potentially more subject to PUD)	no limit	45%
WDD-2 Standard 2.9.2.2) Waterfront Development District Two areas shall designate all deep-water access sites for water-dependent uses, such as: marinas, commercial fishing, yacht clubs, boat ramps, and parks, as well as all uses allowed in Waterfront Development District One when used in conjunction with a permitted use in WDD-2.	25 but only in conjunction with a specified water-dependent use; potentially more subject to PUD	twice the least setback	45%
WDD-3 Standard 2.9.2.3) Waterfront Development District Three areas shall be designated to preserve and develop existing mixed single-family, duplex, and medium-density multi-family areas with the potential to greatly increase public access to the river, public walkways, and private clubs.	25 but only in conjunction with a specified water-dependent use; potentially more subject to PUD	twice the least setback	45%

Table 7.1

INTERIM DEVELOPMENT APPROVAL PROCESS

An interim development approval process was put in place in February 2006 to allow the city time to conduct neighborhood and infrastructure planning in parts of East Fort Myers and to create new development standards if needed. In 2008 these requirements were extended until February 2010 (see the ordinance text and the affected area on the adjoining map).

The following activities have taken place since February 2006:

- The city contracted with its engineering consultants to examine the effects of higher-intensity development on infrastructure in East Fort Myers. The cost of these studies was borne by landowners who were seeking to develop land near the river. These engineering reports were delivered in early March 2007.
 - McMahon Associates determined the number of intersections that would be need to be signalized for varying scenarios of higher-density development.
 - Malcolm Pirnie compared already-planned water and sewer improvements with a scenario that increased allowable densities of 100 dwelling units per acre for all land west of Tarpon Street. The cost of improvements to meet the new demands were estimated, not including water and sewer treatment plants whose capacity was assumed to be adequate.
- The City Council took the first step toward creating a “Community Re-development Area” (CRA) by approving a resolution on March 26, 2007, declaring that blighted conditions existed in East Fort Myers.
- An East Fort Myers Revitalization and Redevelopment Plan was adopted by the City Council on May 21, 2007 (see page 1.19 for a summary of that plan).
- The City Council approved a new CRA for East Fort Myers during the same meeting, based on findings and recommendations in the new revitalization plan.
- This expanded planning study for East Fort Myers began in the spring of 2008, with completion expected in late spring or summer of 2009.

98.3.16 East Fort Myers Interim Development Approval Process

- A. Due to increased interest in redevelopment of mixed residential areas into high-rise residential uses with increased density and height for that area located east of Billy's Creek along the north and south sides of Palm Beach Boulevard to Seaboard Street, and north of Palm Beach Boulevard east of Seaboard Street, as reflected on Map C, which redevelopment may possibly result in deleterious effects to the neighborhood, the city council has deemed that for an interim period not to exceed February 6, 2010, applications for permits for multifamily residential development shall be considered through the planned unit development process. Multifamily development over 35 feet in height or greater than eight units per acre for property zoned RM-16 or greater than 25 units per acre for property zoned CG and CI, shall be considered through the planned unit development process in accordance with the requirements and procedures of this chapter. Map C reflect the property subject to the interim development approval process.
- B. There are concerns that existing water and sewer lines are of insufficient size to handle an increase in capacity and that roadways are not designed or adequate to handle any significant increase in traffic volumes. Additionally, fire flows in the area are insufficient to handle additional demand without upgrading the existing utility system. Allowing increased density and height within this area without proper planning and consideration of the above referenced deficiencies/needs would result in adverse impacts to the neighborhood and community as a whole. Any development that proposes to increase density or height within the area reflected on Map C, through the planned unit development process, shall be required to pay its proportionate share of costs associated with any and all studies the city deems necessary to address possible infrastructure deficiencies and needed improvements resulting from those studies.

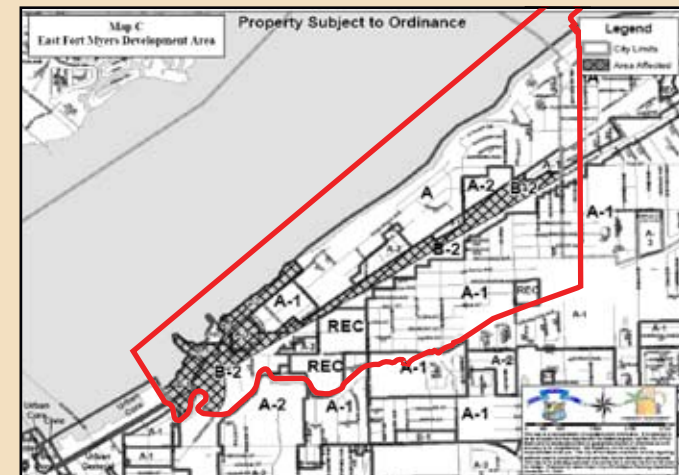

Figure 7.3: East Fort Myers Development Area

CURRENT COMPREHENSIVE PLAN AND ZONING MAPS

The city's Comprehensive Plan contains a Future Land Use Map (FLU map) and the city's new Land Development Code contains a zoning map. At present these two maps are nearly identical except that they use different names for the districts. Figure 7.4, located on the following page, shows the current districts with the FLU map designation listed first, followed by the zoning designation.

Having two separate land-use maps is standard for Florida cities and counties. A FLU map is the long range plan, whereas the zoning map indicates exactly what each parcel can be used for today. The zoning map, and all revisions to it, must be consistent with the FLU map and with the remainder of the Comprehensive Plan. Until last year, Fort Myers was unusual for Florida cities by having only a single map. This condition was the result of Fort Myers deciding in the late 1980s to essentially rename its zoning map as its FLU map. During a period of little or no growth, that system was simple to understand and caused few problems. However, as Fort Myers began to grow again, the single-map system became cumbersome. FLU map changes, by state law, are difficult to make, and require approval by the state. What should have been routine local zoning decisions became far more complex, either by requiring FLU map changes, or

more commonly but incorrectly by being made through the equally-cumbersome PUD (Planned Unit Development) process.

Fort Myers is now transitioning to a two-map system. The first step, an outcome of the evaluation/appraisal process, was the adoption of Policy 2.22 which committed the city to this transition: "The City will maintain an Official Zoning Map by creating an initial zoning map based on the Future Land Use Map by February 2008." The second step was adoption of an official zoning map by the City council in January 2008. The third and final step will be to change the FLU map to a more generalized vision of the City's future. An important goal of the East Fort Myers planning process is to formulate a revitalization vision for East Fort Myers that can be incorporated into the new Future Land Use Map.

Table 7.2 below summarizes the most critical parameters that currently control development in East Fort Myers. On the left side are the standards that are regulated in the Comprehensive Plan; on the right are the Land Development Code standards. Both sets of standards are mandatory, with the more restrictive controlling.

Future Land Use Map Designations				Corresponding Zoning Districts			
FLU Map NAME	Residential Density	Building Height	Building F.A.R.	Zoning Map NAME	Residential Density	Building Height	Building/Lot Coverage
B-2	-	-	1.0 (except downtown)	CI	25	60'	45%
B-1	-	-	1.0 (except downtown)	CG	25	60'	45%
I-1	-	-	1.0 (except downtown)	IL	-	60'	45%
A-3	16	-	-	RM-16	16 (more possible by conditional use?)	60'	45%
A-2	12	-	-	RM-12	12 (more possible by conditional use?)	45'	45%
A-1	7.26 (increase to 8 being considered)	-	-	RS-7	5,000 SF minimum lot size	35'	40%
A	6.22 (increase to 8 being considered)	-	-	RS-6	7,000 SF minimum lot size	35'	40%

Table 7.2

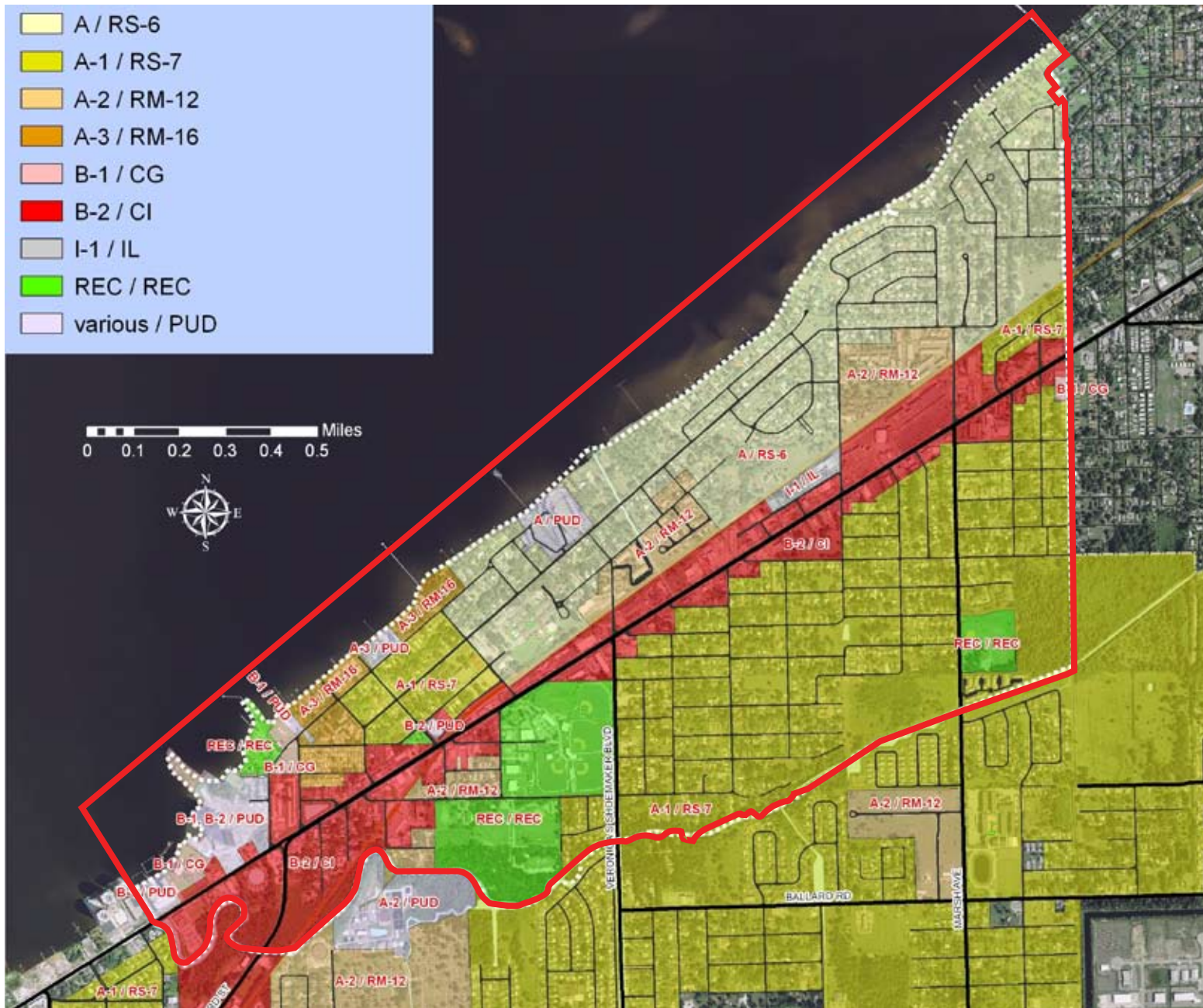

Figure 7.4 Today's land-use designations for East Fort Myers — Future Land Use Map designation listed first, followed by zoning district

EAST FORT MYERS TRANSECT MAP

Chapter four described a variety of physical actions that would carry out the projects earlier described in this plan's four-point strategy. Collectively these actions would create five nodes of intense activity in East Fort Myers as shown below. A challenge of this planning effort is to translate revitalization strategies into individual steps that can be carried out over time. One way is to generalize these strategies into zones of urban intensity upon which future development regulations can be based. The map below depicts the distribution of 'nodes of urban intensity' throughout the study area. There are major nodes and minor nodes. These nodes have been located based upon the following considerations:

1. They are located along existing railways and major roads and thus have the potential to be transit-served when passenger rail service is revived and when bus service with short headways (less than ten minutes between buses) or street car service is inaugurated.
2. They are located at major intersections that already function as commercial crossroads.
3. They are each accessible (easy walking distance) to several neighborhoods and define the edges of neighborhoods.
4. They are located near existing civic resources such as schools and parks.



Figure 7.5 Nodes of urban intensity

This approach was used in 2002, when a SmartCode was created for downtown Fort Myers. The Downtown Fort Myers Plan (formally adopted later, in 2003) was translated into intensity zones known as the “urban-to-rural transect” that are now in common use across the country. The exact transect zones used in the downtown SmartCode are not a good fit for East Fort Myers or other areas outside downtown, but here are a series of similar zones that would be ideal:

- T1 (lowest intensity zone), includes wilderness areas such as Billy’s Creek.
- T2, rural or active farmland, is not present in East Fort Myers.
- T3, suburban residential, low-density consisting mostly of detached homes.
- T4, includes a greater variety of housing types, occasional commercial uses, and higher intensities than T3.
- T5, suburban center, has more mixed-use and density than T1-T4.
- T6, urban core, often has high-rise towers. These would not be appropriate for East Fort Myers because the infrastructure needed to support that pattern is unlikely to ever exist beyond downtown.

Transect-zone designations are often used to replace zoning districts, as in the downtown SmartCode. For East Fort Myers (and other parts of the city), a better application would be to use these designations on the new Future Land Use Map. This would set the stage for several different methods of determining the exact level of intensity that would be allowed on each block, as described in detail on page 7.18 under the heading “Ensure Better Development Patterns.”

Once the centers of urban intensity nodes were identified, each block near the center was examined based upon the criteria on the previous page, to determine the maximum distance from the center each node might extend. This step is critical because a T5 designation would be the most permissive in terms of building height, residential density, and flexibility in permitted uses. The next zone, T4, would surround each T5 designation. T4 would allow a wide range of less-intense building types that would be suitable between T5 and the existing neighborhoods of detached homes.

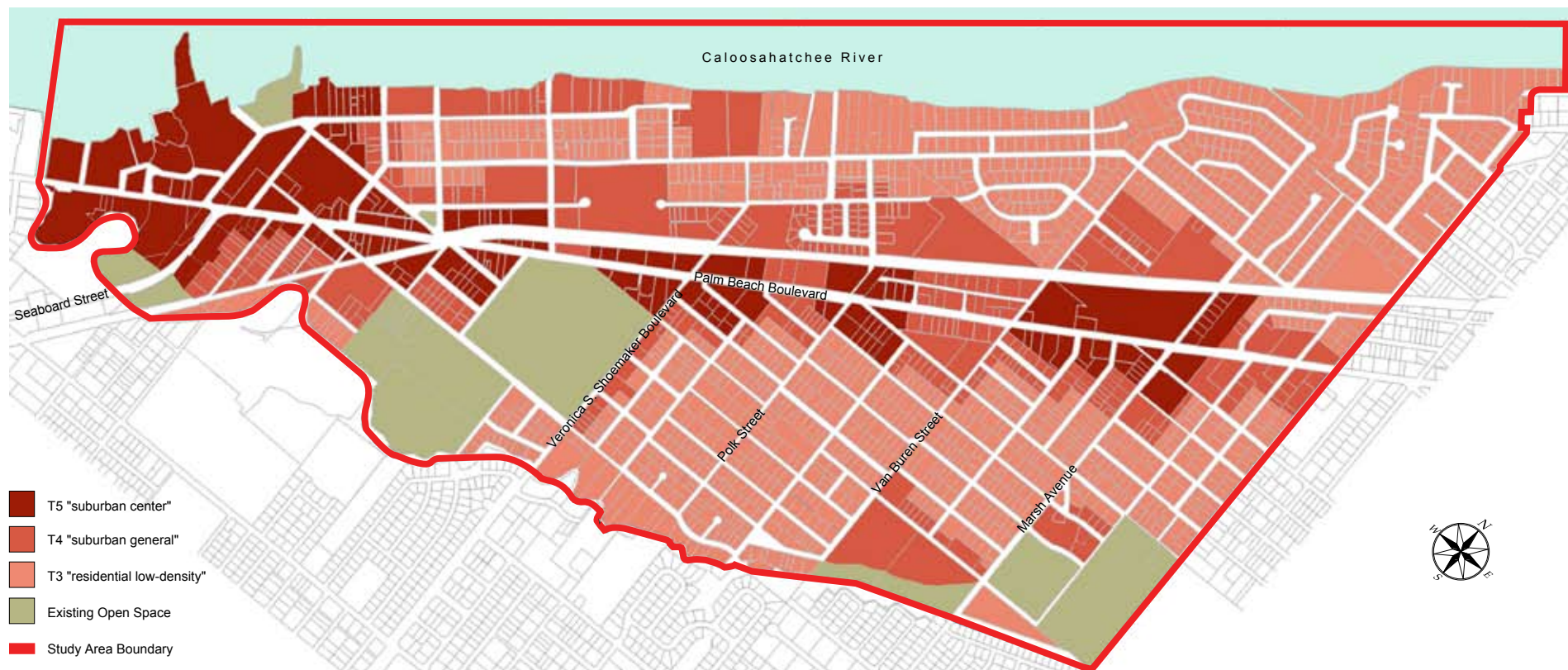

Figure 7.6 Proposed transect designations for East Fort Myers

PROPOSED COMPREHENSIVE PLAN “FUTURE LAND USE MAP”

The preparation of a completely new “Future Land Use” map for Fort Myers is now underway; a proposal for East Fort Myers is described here.

The majority of land in East Fort Myers contains single-family homes on individual lots. At present these neighborhoods have various designations based on minimum lot sizes. With those distinctions now shown on an official zoning map, there is no reason for them to be repeated on the FLU map. In fact a decision was previously made to consider combining them:

Action 2.1.3) By December 2007, the City of Fort Myers shall evaluate merging its five single-family development future land use map designations (AAA, AA, A, A-1, and A-1D) into a single, unified future land use designation with a maximum density permitted of 8 residential units per acre.

Those parts of East Fort Myers where a new consolidated “Residential Low-Density” designation should be applied are shown with light yellow cross-hatching in the Future Land Use map, shown in Figure 7.7. This designation would consolidate most existing “A” and “A-1” property. These neighborhoods contain primarily detached homes; this designation would formalize the city’s intention to maintain this same character in the future. Changes to this character can only be considered by the city if the FLU map is amended. Zoning changes may be made without a FLU amendment only if the new zoning district is consistent with all requirements of the “Residential Low-Density” designation.

In keeping with current practice, the new FLU map should identify all city and county parks, including the new Billy’s Creek filter marsh, as “Parks & Recreation.” Other city land with park potential should be included as well, for instance the Tarpon Street pier, the proposed Princess Street sunset overlook along the river, and the triangular playground site at Alderman and Pearl Streets just north of Billy’s Creek. As additional land is acquired for parks, that land should be given this same designation through the plan amendment process. The proposed initial “Parks & Recreation” designations are shown on the map with light green cross-hatching. *See page 7.15.*

Two additional designations are needed to carry out this plan for East Fort Myers. These designations would indicate where in East Fort Myers higher-intensity development may be appropriate; these areas are based on the transect map presented on the previous page. Development-intensity zones are similar in concept with the “transect zones” that Fort Myers began using on the FLU map in 2004 to implement the downtown plan.

The highest-intensity designation used in East Fort Myers could be called “Suburban Center” (which corresponds to T5 and is similar to but less intense than downtown’s “Urban Center”). This new designation would be applied at five locations along Palm Beach Boulevard, centered at the intersections of:

- Seaboard Street / East Riverside Drive
- Fremont Street
- Veronica S. Shoemaker Boulevard
- Polk Street
- Marsh Avenue

Each of these locations has good potential for more intense development and/or a greater mix of land uses, as discussed in Chapters 4 and 5. Each would be well-served by public transportation — even more so if passenger rail service is restarted in the future. The proposed locations are shown with red cross-hatching. Historic structures in this zone should be formally designated by the city so that redevelopment of these properties will maintain their historic significance.

The second new designation could be called “Suburban General” (which corresponds to T4). This new designation would be applied along Palm Beach Boulevard between the “Suburban Center” nodes and would also be applied to portions of adjoining or transitional neighborhoods that have at least one of the following characteristics:

- Multifamily buildings or a mixture of housing types (at present).
- Excellent potential to introduce a wider mix of housing types in locations close to public transportation, shopping, and employment opportunities.
- Some potential for the sensitive expansion of commercial uses beyond existing commercially zoned property.
- Located directly across the street from land with the characteristics listed above.

The proposed locations for “Suburban General” (T4) are shown with orange cross-hatching. Although much of this land has a commercial designation at present, a considerable portion of it is zoned only for detached homes. To take advantage of the potential for higher intensities, either landowners or the city itself would have to request rezoning, which the City Council could grant only for requests that are consistent with all requirements of the new “Suburban General” designation.

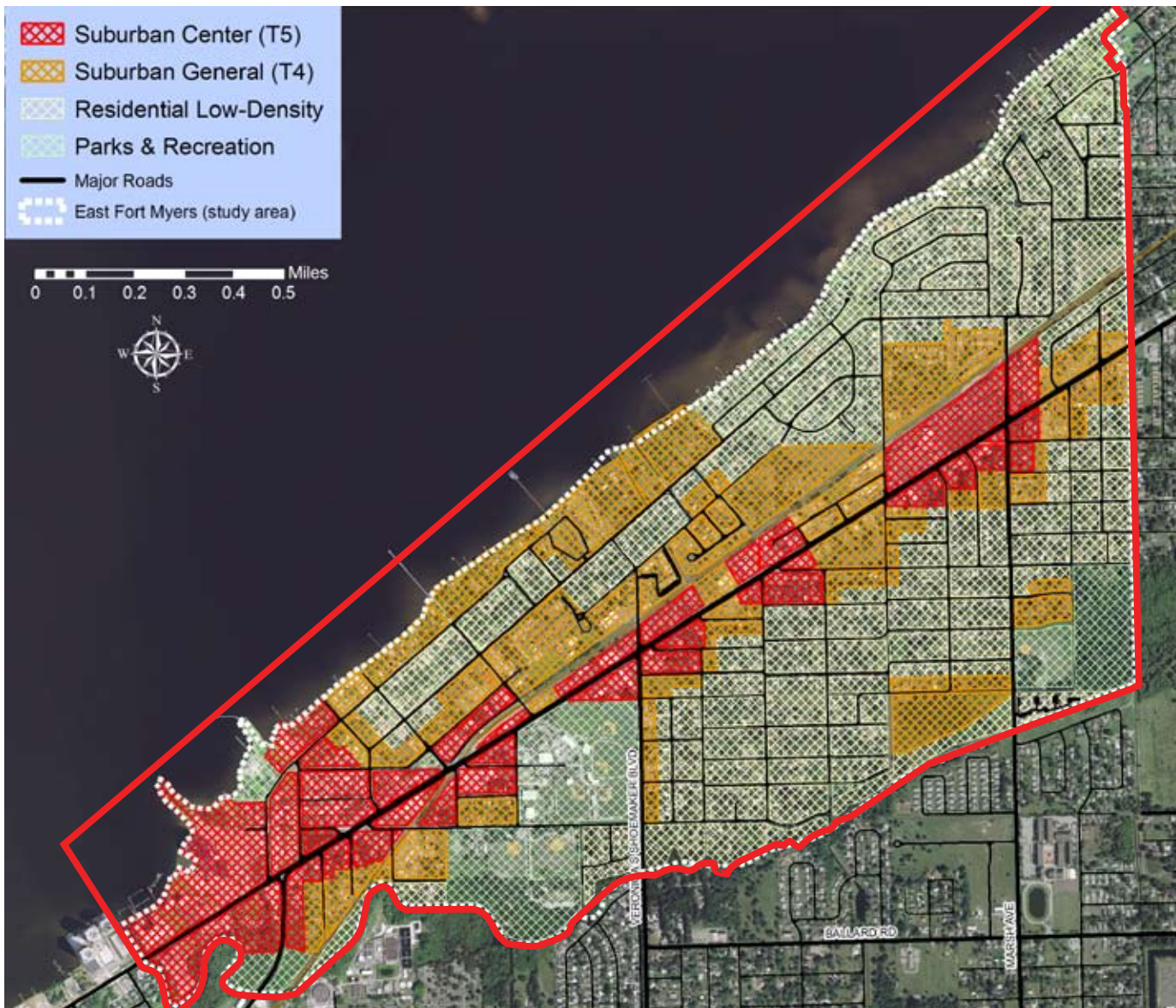

Figure 7.7 Proposed designations for the new Future Land Use Map as revised by the CRA Board in March 2010

ACTION STEP # 9 FUTURE LAND USE MAP

The new Future Land Use Map being formulated for the city of Fort Myers should be a primary implementing tool for this East Fort Myers plan.

- A new designation, “Suburban Center,” (T5) should identify the outer extent of future higher-intensity nodes along Palm Beach Boulevard.
- Another new designation, “Suburban General,” (T4) should be applied between and behind these centers to encourage a greater mix of housing types with some compatible retail and office uses.
- Most existing A and A-1 property should be consolidated into a single “Residential Low-Density” (T3) designation to maintain the existing character of these neighborhoods.
- A new “Parks & Recreation” designation should be applied to Riverside Park, Terry Park, Shady Oaks Park, the new Billy’s Creek filter marsh, and other existing and proposed parks on public property.

COMPREHENSIVE PLAN “FUTURE LAND USE ELEMENT”

To carry out the intent of these re-designations, corresponding changes are needed to the text of the Comprehensive Plan (in the Future Land Use Element). The most important change will be to clearly define the intent and effect of the new designations.

The new “Suburban Center” and “Suburban General” designations would be fundamentally different than the current B-1 and B-2 designations, which are little more than pyramidal zoning categories. Although both B-1 and B-2 allow a mix of uses, what actually gets built on those properties is almost impossible to foresee, because:

- Commercial uses are allowed on every B-1 and B-2 property, even where residential uses would be better for the neighborhood.
- Maximum building heights and densities can be greatly increased during the rezoning process.
- The code itself is not designed to place individual buildings in a manner that creates a desired urban form, or any particular urban form at all.

Landowners and developers who understand the system sometimes achieve great increases in the value of their property during the development approval process; but little predictability is provided to the public about the future character of their community. Ironically, this system doesn’t provide sufficient predictability even to applicants because so many types of development are required to use the PUD process where everything seems negotiable but no particular outcome is assured.

The basis for a better system of regulatory approvals would be the two new FLU map designations that identify the overall intensity and form of future buildings while still allowing a broad mix of uses. Once this framework is established, the decisions on potential uses for individual lots would be made during the rezoning process, which is inherently better suited to lot-by-lot determinations. Potential code changes to govern this zoning process will be discussed in the “Ensuring Better Development Patterns” section of this report.

A potential difficulty with the proposed FLU map designations is that the Florida Department of Community Affairs (DCA), which must approve all Comprehensive Plan changes, has taken an increasingly hostile view of mixed-use designations over the past decade. Even though the current designations freely allow mixed uses, DCA could take this opportunity to impose its more recent interpretations on the City of Fort Myers. This difficulty must be acknowledged but it should not deter city officials from creating the best plan for the future of Fort Myers.

The following descriptions could be used to define the character and intensity of the two new FLU designations:

- “Suburban Center” defines future nodes of higher-intensity land uses along major roads. Additional commercial and mixed uses are anticipated in multi-story buildings that accommodate retail and office uses with residential or lodging uses above. Parcels larger than two acres generally must be subdivided into individual blocks to insure a walkable development pattern. Streets will have wide sidewalks with consistent street tree planting. Most parking spaces will be shared; parking structures are encouraged as an alternative to surface lots provided they are lined with habitable space so that sidewalks are faced with frequent doors and windows.
- “Suburban General” defines transitional zones within walking distance of a center of activity. Commercial and mixed uses will predominate along major roads, surrounded by a primarily residential fabric that include a range of building types including row houses (townhouses), small apartment buildings, live/work units, bungalow courts, and detached homes. Parcels larger than two acres generally must be subdivided into individual blocks to insure a walkable pattern of development. The street network is highly interconnected and setbacks are short. The outer edges of “Suburban General” should be compatible in scale with detached homes on individual lots.



Figure 7.8 Proposed intensity levels for East Fort Myers.

Once these broad categories are established, the land development code can implement specific city policies. For instance, a commonly observed problem on Palm Beach Boulevard is the proliferation of used car dealers. Regulations could be tolerant toward this use in Suburban General but more restrictive in Suburban Center so that land in emerging high-intensity nodes is not converted to pedestrian-unfriendly car lots.

ACTION STEP # 10 **FUTURE LAND USE ELEMENT**

The Future Land Use Element should be amended to define these new designations for the Future Land Use Map:

- “Suburban Center,” to define future nodes of high-intensity land uses along major roads.
- “Suburban General,” to define transitional zones within walking distance of “Suburban Centers.”

REGULATORY CAPS ON BUILDING BULK

To accomplish the goals of the new “Suburban Center” and “Suburban General” designations, the current limitation on the percentage of a lot’s area that can be used for buildings should be modified or omitted.

The current B-1 and B-2 designations are subject to a Comprehensive Plan provision that limits building square footage to the square footage of the lot:

Standard 2.8.2.3) Commercial areas shall not exceed a FAR of 1.0, except in the Downtown Redevelopment Area.

“FAR” is an abbreviation for floor-to-[lot]-area ratio. A FAR of 1.0 means the building’s area cannot exceed the lot’s area; a one-acre lot, which has 43,560 square feet of land, cannot have buildings that contain more than the same amount of floor space (43,560 square feet). If a two-story building were planned, each story could contain only half of the lot area, or 21,780 square feet.

This cap is reasonable for low-rise development in areas with large parking lots and little public transit or pedestrian usage. However, it would be overly restrictive in “Suburban Center” and the more intense portions of “Suburban General.”

Much of this problem would resolve itself because the FAR cap is embedded in the Comprehensive Plan’s B-1 and B-2 regulations and thus would no longer apply in East Fort Myers once the suggested redesignations have been made. However, a variation on this type of cap still appears in the Land Development Code. A “building coverage”¹ cap of 45% (0.45) applies in the CG and CI zoning districts (formerly B-1 and B-2 respectively). “Building coverage” essentially measures the building’s footprint; unlike FAR, building coverage disregards all floor area above the first story.

This 45% cap would be too restrictive for many desirable building types in the new “Suburban Center” designation, for instance urban buildings with an embedded parking garage which do not need any of the remaining 55% of the lot for parking or driveways. In “Suburban General,” this cap would cause few problems but would not be necessary if zoning districts contained more precise building form standards.

ACTION STEP # 11 **FLOOR-TO-AREA RATIOS**

The Future Land Use Element should be modified to eliminate the existing floor-to-lot-area ratio (FAR) cap of 1.0 for East Fort Myers. The preferred method would be replacing the existing B-1 and B-2 designations as recommended in Action Step #9.

- The Land Development Code should be modified to eliminate the existing “building coverage” cap of 45% for East Fort Myers that is contained in the existing CG and CI zoning district regulations.

1 - Building coverage means “the maximum area of the lot that is permitted to be covered by buildings, including both principal structures and accessory buildings. Building coverage does not include paved areas such as driveways, uncovered porches or patios, decks, swimming pools or pool cages.” (Fort Myers LDC, Section 118.16.G.2)

ENSURING BETTER DEVELOPMENT PATTERNS

The City of Fort Myers adopted significant revisions to its Land Development Code in January 2008. Further updates are currently in progress.

These revisions have greatly improved the way the code is organized and have made it more understandable to the public. However, to date no revisions have been drafted that would remedy several remaining shortcomings in the code:

- There are very few “building form” standards that would provide assurances to the public that new buildings will either match the historic character of Fort Myers or contribute to the intended character of higher-intensity development such as the concepts for East Fort Myers that are suggested in this plan. (Building form standards are found in the downtown SmartCode but they do not apply anywhere else in the city.)
- There are no standards in the code that will prohibit some of the more egregious practices sometimes seen in new development – tall blank walls facing streets; large parking lots separating businesses from sidewalks and streets; and inappropriate buildings for drug stores or fast-food franchises that serve more as giant signs than as sustainable buildings. Buildings should be adapted to the character of their surroundings and be able to serve many different uses during their lifespan.

These problems are related but not identical. For instance, city officials may decide to allow large parking lots and generic franchise buildings in newly developing areas of the city but restrict or forbid them in older parts of the city.

In that instance, the city could adopt basic architectural standards for the newly developing areas similar to those already adopted by Lee and Collier Counties. Such standards often forbid blank walls and require architectural customization, for instance to make big-box warehouses appear less massive.

However, architectural standards are the wrong tool to regulate the placement of buildings or to require that large parcels be subdivided into walkable blocks, all of which are essential to create a viable and vibrant city. The existing (and desired) conditions in the traditional parts of Fort Myers are simply different:

- Parcels of land are much smaller, requiring smaller buildings than are typically built in newly developing areas.
- New buildings should be close to sidewalks to serve and bicyclists, not set back behind large parking lots.
- New buildings need doors and windows facing the street to welcome customers and encourage movement on foot, which is an essential part of each end of a trip on public transportation.

- Remaining larger parcels need to be subdivided into walkable blocks to complete the historic street grid.

Land development regulations of this nature have come to be known as “form-based codes” to distinguish them from conventional architectural standards or guidelines. The downtown SmartCode is one type of form-based code.

The remainder of this section will analyze different ways that Fort Myers could modify its Land Development Code so that incremental building activities will add up to desirable development patterns such as those described in this plan.

The city’s new Land Development Code contains a feature that could implement some form-based standards within the format of a conventional zoning code; this feature is defined in the new code but has not yet been applied to any neighborhoods. Section 118.2.2.C allows the city to designate different “frontage conditions” for commercial development that would have specific regulations on building form depending on what kind of street the building faces. For instance: one set of rules would apply to buildings with the greatest potential for foot traffic; another would apply to nearby streets with less potential or that are needed for loading, access to parking lots, or truck traffic.

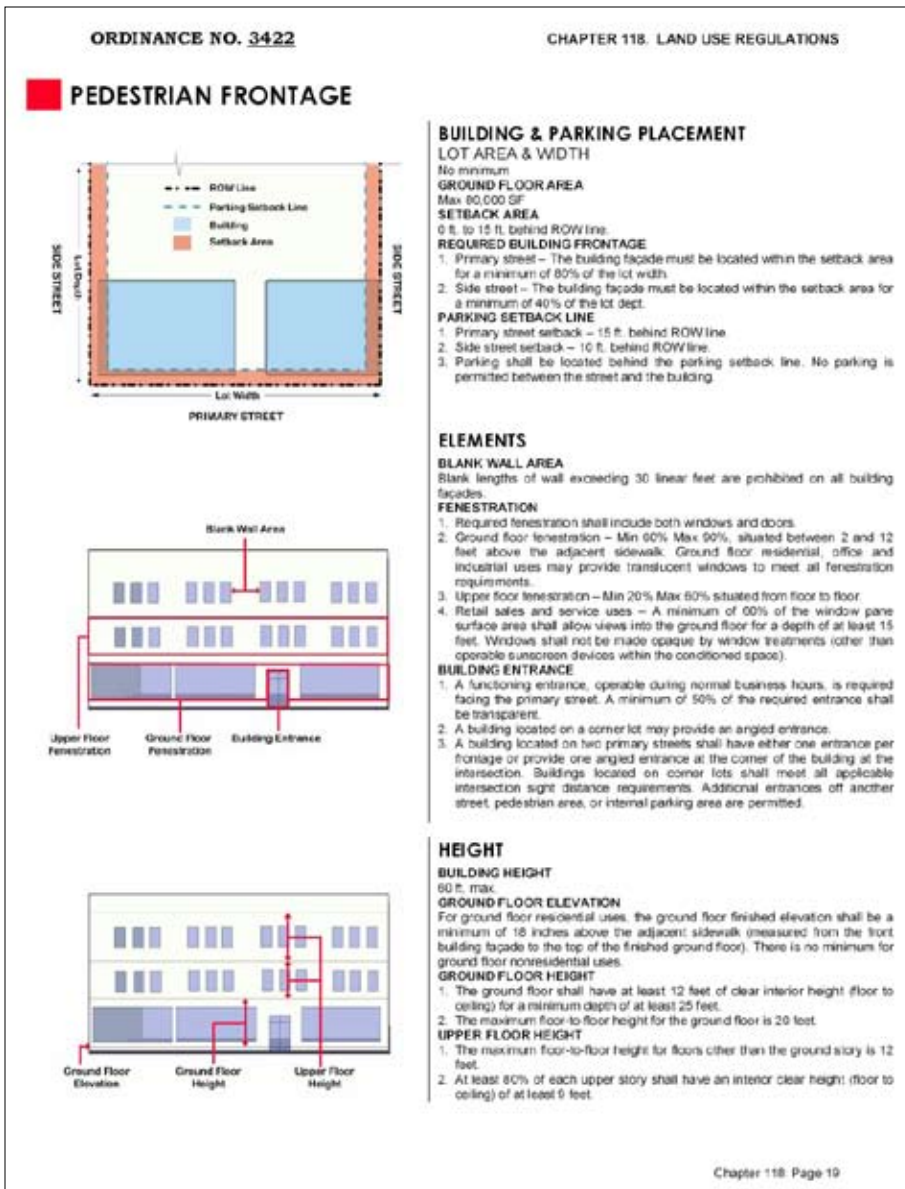

Figure 7.9 New "Pedestrian Frontage" standards in the Fort Myers LDC.

These "frontage" designations would appear on the zoning map, not as a replacement zoning district or an overlay district, but with solid or dashed bars along the street edges of lots to be affected. These bars would be applied only after careful examination of individual blocks relative to the recommendations of a design-oriented planing effort such as this one. Once these designations are applied to the zoning map, the corresponding building form rules would immediately apply to new development and redevelopment on those blocks.

These frontage designations would need to be refined to implement this plan for East Fort Myers. Once refined and applied, the city would have a new tool to help implement this plan for East Fort Myers without changing any of the existing CG and CI (formerly B-1 and B-2) zoning.

Architectural standards are a simple but only moderately effective way to shape new development. The application of "frontage conditions" as just described would be a somewhat more effective approach for Fort Myers. Both approaches could retain the existing CG and CI zoning districts while trying to remedy their shortcomings with additional regulations. However, keeping the existing districts would be a handicap because essential problems with conventional CG and CI zoning would still remain – yet these problems cannot be repaired without affecting how those same zoning districts affect other land throughout the entire city.

A third and better approach would create one or more new zoning districts that could be applied to the new "Suburban Center" and "Suburban General" FLU map designations. The new district could be partially or entirely "form-based," which can be contrasted with conventional zoning as follows:

Form-Based Zoning	Conventional Zoning
Focuses on the placement and bulk of buildings in order to create a defined "public realm"	Buildings can be placed randomly on large parcels, without concern for adjoining buildings
Merges planning for streets, sidewalks, and public spaces with planning for new buildings	Generally does not apply at all to streets, sidewalks, or other public spaces
Quite detailed; most requirements are prescriptive (what SHOULD or MUST be done)	Fairly general; most requirements are proscriptive (what CANNOT be done)
Describes most rules with a combination of words, matrices, and graphics	Describes most rules only with words and matrices
Focuses on the form of buildings and public spaces more heavily than on uses of land	Focuses heavily on the regulation of uses of land; building form is very secondary

Table 7.3 A comparison of Form-Based Zoning versus Conventional Zoning

If Fort Myers chooses to prepare and adopt a form-based code to implement the East Fort Myers plan, it should be done in a format and with techniques that can be used again to implement other neighborhood and redevelopment plans in the future. The new district or districts would replace the existing zoning only for the property that it was designed to affect. In this way, the zoning is

customized for the immediate purposes instead of using city-wide standards that must consider conditions that exist somewhere else in the city but may not exist in East Fort Myers. The images below show two different formats for presenting requirements of form-based codes.

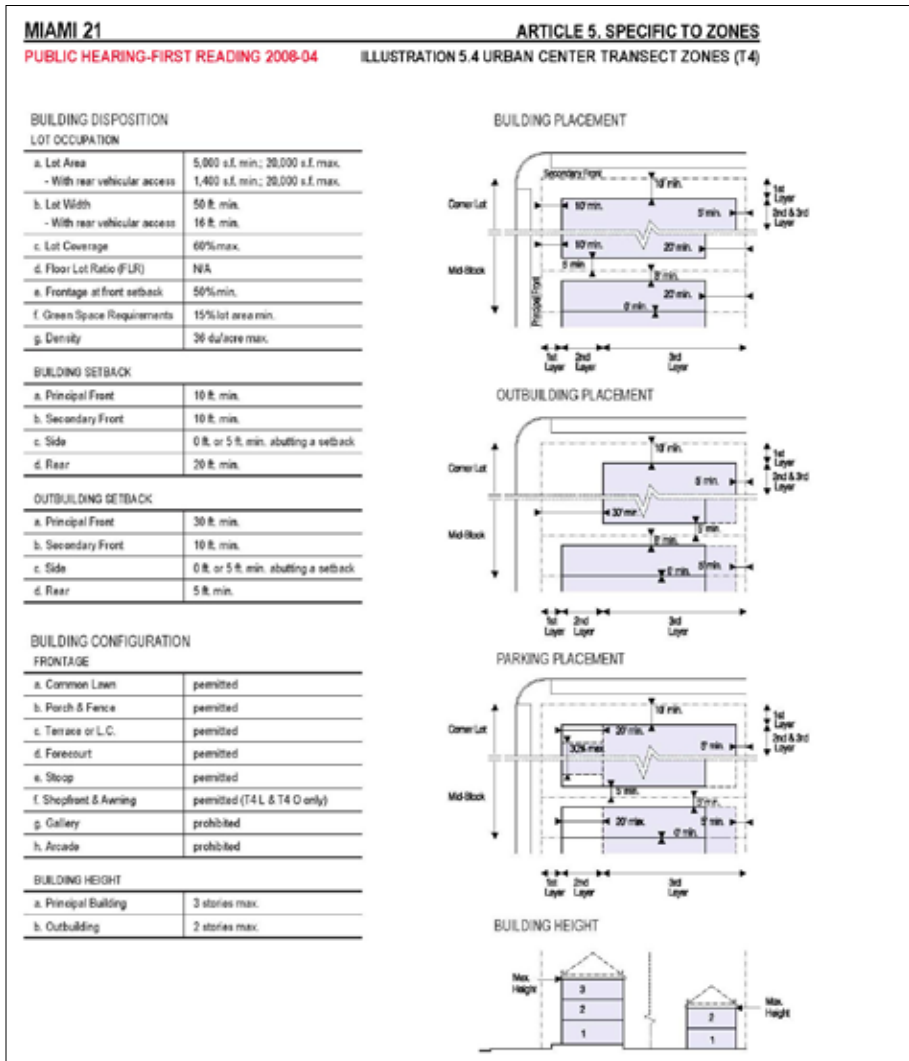

Figure 7.10 Form-based code format that presents the requirements in a very concise fashion.

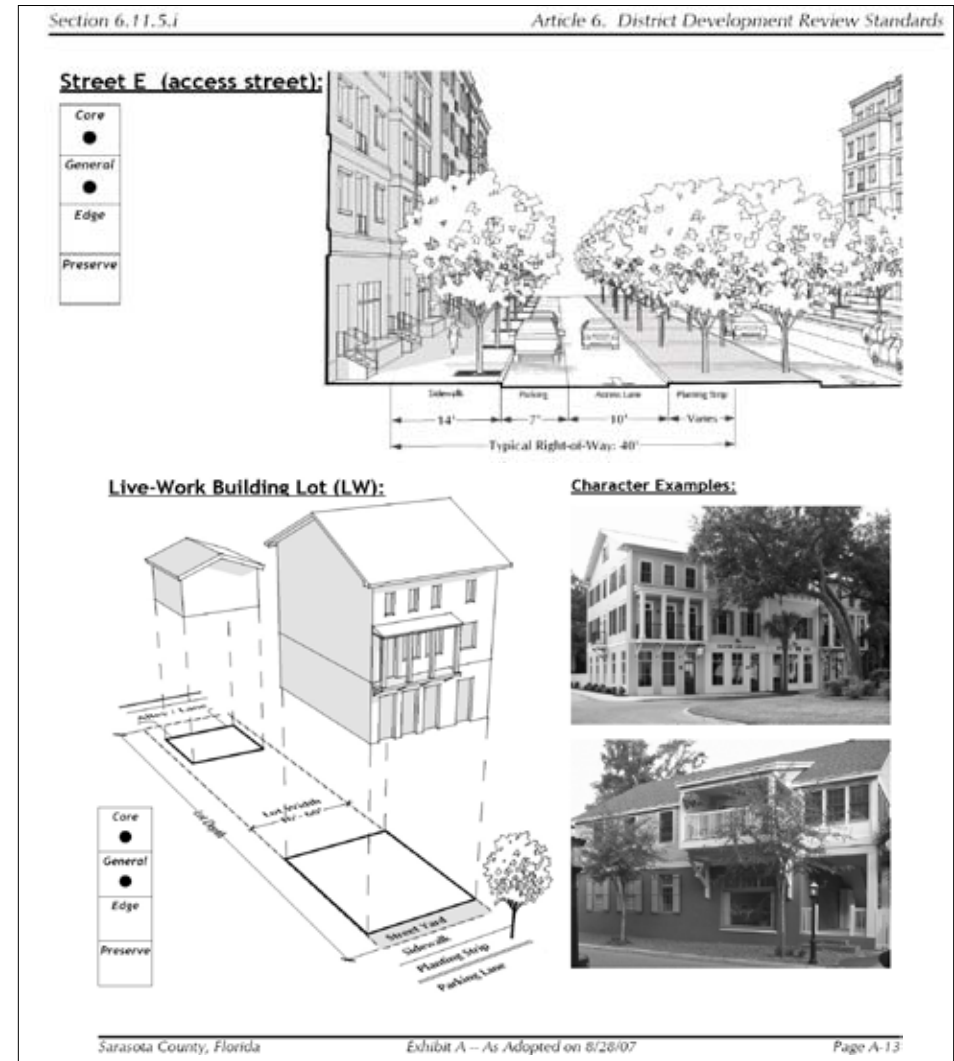

Figure 7.11 Form-based code format that presents the requirements in a more visual manner.

DESIRED DEVELOPMENT PATTERN

The City Council and CRA Commissioners considered a detailed proposal that emerged from this planning process to prepare a full form-based code that would authorize and regulate future redevelopment of private property.

Instead of a form-based code that would provide a predictable urban form, the City Council chose an alternative approach which would provide greater flexibility to landowners who wish to develop or redevelop land in East Fort Myers. This flexibility would be provided through several methods:

- Increasing the base density and height regulations for new buildings in the T4 and T5 transect zones.
- Further increasing building heights to twice the least proposed setback.
- Allowing parts of the riverfront esplanade to be constructed over the river.
- Requiring habitable space around parking structures only on ground stories that face public streets (instead of on all stories that face public spaces).
- Allowing the PUD process to be used for projects that seek additional uses, density, transfer of development rights, height, or design alternatives not 100% consistent with the zoning regulations.

The proposed FLU map described earlier would still assign all land in East Fort Myers to one of four designations:

- Suburban Center, nodes of higher-intensity land uses (corresponding to the T5 transect zone).
- Suburban General, transitional areas within walking distance of higher-intensity nodes (T4).
- Residential Low-Density, neighborhoods of primarily detached homes on individual lots (T3).
- Parks & Recreation, public parks (T2).

The Suburban Center higher-intensity nodes (T5) would be broken into two sub-zones; one would apply to the major nodes along Palm Beach Boulevard and the other would apply to land near the Oasis towers. Suburban General areas (T4) would also be broken into two sub-zones; one would be used between major nodes along Palm Beach Boulevard and for riverfront lots, freely allowing most commercial uses, while the other would be designed for nearby neighborhoods where live-work units, townhouses, and mixed multifamily units would be the predominate form of redevelopment.

The following charts describe the type of requirements that would generally apply. The PUD rezoning process could be used to consider additional uses, density, transfer of development rights, height, or design alternatives not 100% consistent with the zoning regulations provided they are consistent with the

Comprehensive Plan. Later public hearings would be required to change the Land Development Code and Comprehensive Plan before recommendations such as these would become controlling regulations (see Action Step #15).

SUGGESTED REQUIREMENTS FOR LAND DESIGNATED “SUBURBAN CENTER” (T5)

SUB-DISTRICT #1 (near Oasis Towers):

Maximum Density:

60 dwelling units per acre consistent with the Comprehensive Plan.

Maximum Building Height:

10 stories (or twice the least proposed setback), plus up to four additional stories provided the square footage of each additional story is less than 70% of the largest lower story.

Build-to Zone:

0' to 10' (along at least 75% of principal frontage)

Additional Requirements:

- Buildings may have non-residential uses.
- All parking structures must be lined by habitable space with doors and windows on ground stories that are close to public streets. Habitable space may include residential, office, retail, or recreational uses.
- A minimum 25-foot-wide esplanade easement will be required along the Caloosahatchee River; the esplanade may be constructed partially over the river where insufficient upland width is available.

SUB-DISTRICT #2 (nodes along Palm Beach Boulevard):

Maximum Density:

25 dwelling units per acre

Maximum Building Height:

6 stories

Build-to Zone:

0' to 5' (along at least 75% of principal frontage)

Additional Requirements:

- Buildings may have non-residential uses at ground level.
- All parking structures must be lined by habitable space with doors and windows. This applies to both ground and upper stories that face streets, squares, plazas/parks, the Caloosahatchee River, and Billy's Creek.

**SUGGESTED REQUIREMENTS
FOR LAND DESIGNATED “SUBURBAN GENERAL” (T4)**

SUB-DISTRICT #1 (riverfront land and land between nodes along Palm Beach Boulevard):

Maximum Density:
25 dwelling units per acre

Permitted Building Height:
5 stories or twice the least proposed setback

Build-to Zone:
0' to 10' (along at least 75% of principal frontage)

Additional Requirements:

- Some buildings may have non-residential uses.
- All parking structures must be lined by habitable space with doors and windows on ground stories that are close to public streets. Habitable space may include residential, office, retail, or recreational uses.
- A minimum 25-foot-wide esplanade easement will be required along the Caloosahatchee River to Tarpon Street; the esplanade may be constructed partially over the river where insufficient upland width is available.

SUB-DISTRICT #2 (transitional neighborhoods):

Maximum Density:
16 dwelling units per acre

Permitted Building Height:
3 stories

Build-to Zone:
0' to 15' (along at least 65% of principal frontage)

Additional Requirements:

- Occasional buildings may have non-residential uses.
- All parking structures must be lined by habitable space with doors and windows on ground stories that are close to public streets. Habitable space may include residential, office, retail, or recreational uses.

**SUGGESTED REQUIREMENTS
FOR LAND DESIGNATED “RESIDENTIAL LOW-DENSITY” (T3)**

Maximum Density (may be further restricted by zoning):
8 dwelling units per acre

Maximum Building Height:
2 stories

Build-to Zone:
5' to 20' (along at least 50% of principal frontage)

CITY POLICY TOWARD NEIGHBORHOOD PLANS

The Comprehensive Plan addresses neighborhood and revitalization plans in Policy 5.3 of the future land use element:

Policy 5.3) Special planning and implementation efforts will be continuously conducted for targeted neighborhoods (see Map E).

Action 5.3.1) Detailed neighborhood plans or community redevelopment plans will be prepared and adopted for various neighborhoods within the defined geographic area (Map E).

Action 5.3.2) Upon completion of the specific redevelopment plans, special Neighborhood Redevelopment Districts shall be designated on the Future Land Use Map and implemented through the Land Development Regulations. It is the express intent to promote the redevelopment of areas through special controls, economic incentives, and public as well as private investment.

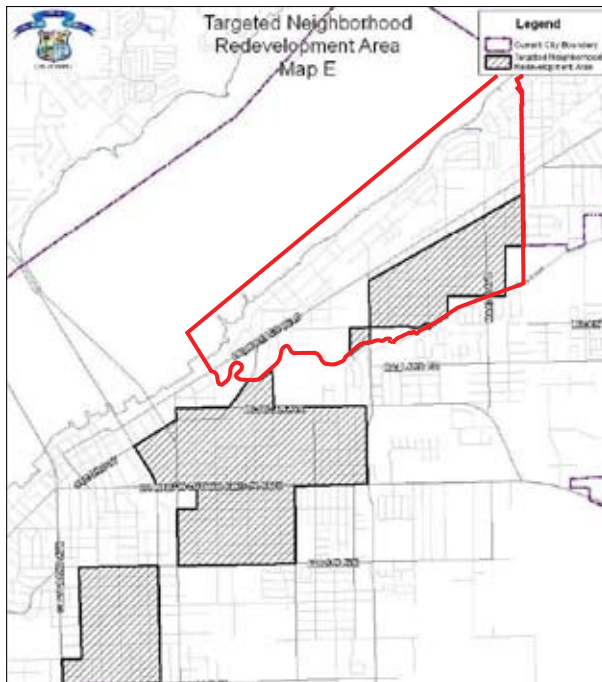

Figure 7.12 Comprehensive Plan Map E, with East Fort Myers boundary in red.

Action 5.3.3) The following redevelopment, neighborhood, or special plans are included in the Comprehensive Plan as if set forth in full herein and shall be implemented to the greatest extent feasible:

- East Downtown Neighborhood Plan;
- Edison Park Neighborhood Plan;
- Central Fort Myers Area Study;
- Velasco Village
- Redevelopment Plan;
- Winkler Safe Neighborhood Improvement District Plan;
- Westwood Redevelopment Plan;
- Palm Beach Boulevard Community Plan;
- Urban Infill & Redevelopment Area, as shown on Map E-A; and,
- Dr. Martin Luther King, Jr. Boulevard / Veronica S. Shoemaker Corridors Revitalization Plan.

ACTION STEP # 12 NEIGHBORHOOD AND REVITALIZATION PLANS

The current wording of Action 5.3.3 of the future land use element could be interpreted to require an amendment to the Comprehensive Plan each time a neighborhood or special plan gets amended, which would be an unnecessary impediment to the planning process. This action should be reworded to resolve that concern and to make the following additional changes:

- Eliminate obsolete plans from the list (e.g., East Downtown Neighborhood Plan) and remove obsolete planning boundaries from the maps (e.g., the hatched area between of Palm Beach Boulevard and Billy's Creek on Map E).
- Provide the correct name for all plans that belong on this list.
- Combine Maps E, E-1, and E-A so that a single map identifies all of the city's special planning areas consistent with the boundaries in the plans listed in Action 5.3.3.
- Clarify Action 5.3.2 to indicate that Map E is part of the Future Land Use Map series and these boundaries do not need to be repeated on the main Future Land Use Map.

EXPANDED ENTERPRISE ZONE

The “Enterprise Zone” boundary for central Fort Myers was expanded to include parts of East Fort Myers in 2006. This expansion doubled where numerous state tax benefits are provided to stimulate economic revitalization:

- Job credits, applicable to either corporate income or state sales taxes, are available for eligible companies that create new jobs and hire Enterprise Zone residents.
- Community contribution tax credits against corporate income taxes are available for donations to eligible sponsors of community development projects. (Project sponsors must obtain approval from the state in advance.)
- Property tax credits up to \$50,000 are available against corporate income taxes for new or expanding businesses that create at least five new jobs.
- Sales tax refunds are available for building material purchases for new construction or building rehabilitation. The maximum refund is \$5,000, although it may reach \$10,000 if 20% of employees are residents of an Enterprise Zone. Similar credits are available for purchase of certain business property.



Figure 7.13 Enterprise Zone in East Fort Myers

In Enterprise Zones, Lee County waives county impact fees that would normally be charged to new homes for roads, parks, fire, and EMS service. In 2006 the city of Fort Myers re-authorized and expanded its incentives, which now include the following incentives for activities within city limits:

- Sales tax exemption for electricity (50% of the sales tax paid, or 100% if 20% of employees are residents of an Enterprise Zone).
- 50% rebate on occupational license fees.
- Water and sewer impact fees are waived for construction of a new single-family home.

ACTION STEP # 13 ENTERPRISE ZONE MARKETING

The Enterprise Zone in East Fort Myers offers numerous valuable benefits for new homes and for certain businesses, especially those employing residents in the Enterprise Zone. Aggressive marketing is needed.

- City staff and the new Enterprise Zone Board should assist the Lee County Economic Development Office in aggressively marketing Enterprise Zones to support job opportunities and affordable housing.

ACTION STEP # 14 SOUTHWEST FLORIDA ENTERPRISE CENTER

Expanding the number and variety of local businesses will make more consumer choices available to local residents, offer more opportunities for entrepreneurial activity, and retain more wealth in the community. Business training and start-up facilities are important for the launching and flourishing of local businesses.

- The city should continue to support and publicize the entrepreneurial assistance offered by the Southwest Florida Enterprise Center and the FGCU-based Small Business Development Center and the training opportunities of the High-Tech center located on Michigan Avenue.
- East Fort Myers will have a competitive advantage over its peer communities in attracting new business if it is able to distinguish itself as a leader in environmental entrepreneurship. In recognition of this fact, the Southwest Florida Enterprise Center should begin training programs and business incubation in renewable clean energy and other ecologically-oriented businesses.

EAST FORT MYERS FROM THE CRA PERSPECTIVE

State law sets the requirements for plans that are adopted as formal community redevelopment plans.

The City Council established the East Fort Myers Community Redevelopment Area (CRA) in May 2007 when they adopted the 2007 East Fort Myers Revitalization and Redevelopment Plan (see summary on page 1.19). It was understood at the time that further input from the East Fort Myers community was needed to expand the revitalization vision, which led to this current planning effort.

The city's intent is to adopt this expanded plan as a modification to the May 2007 plan, replacing the former plan in its entirety.

CRA Plans as Regulatory Documents

One of the statutory requirements for a "Community Redevelopment Area" plan is that it must contain "...limitations on the type, size, height, number, and proposed use of buildings."

This language is occasionally interpreted to suggest that a CRA plan should in effect become a second land development code in order to provide these limitations within the plan itself.

The 2007 CRA plan for East Fort Myers had originally been drafted to include several recommendations on building heights, which would have limited various classes of buildings to either three or five stories. Several parties believed that these recommendations would have become immediate development regulations upon adoption of the East Fort Myers CRA plan. These provisions were very controversial during the adoption public hearings, ultimately leading the City Council to delete the height recommendations entirely from that plan, thus allowing the pre-existing development regulations to remain in effect at least until these issues were reexamined.

Although this new plan discusses desirable development patterns in detail, it would be very cumbersome for the public to have one set of regulations located in the city's land development code and another set in the CRA plan. Therefore this plan does not contain any self-implementing regulations as to density or building heights that would override current regulations.

For purposes of compliance with the statutory requirement cited above, limitations on type, size, height, number, and proposed use of buildings will continue to be governed by the city's comprehensive plan and land development code. However, the recommendations of this plan can and should be considered when amending the Comprehensive Plan and Land Development Code, and may also be considered by the Planning Board and City Council when those bodies consider discretionary development approvals such as rezoning requests.

State law forbids a city from adopting a redevelopment plan that is not completely consistent with its Comprehensive Plan. Thus in order to carry out many of the recommendations of this study, later amendments will be needed to the Comprehensive Plan and the Land Development Code. State law does not allow any simpler process.

ACTION STEP # 15

THE STATUS OF CRA PLANS AS REGULATORY DOCUMENTS

This redevelopment plan should not be interpreted to contain any self-implementing regulations that would immediately override the land development code.

- The recommendations of this plan however can and should be considered when amending the Comprehensive Plan and Land Development Code.
- The recommendations of this plan should also be considered by the Planning Board and City Council when those bodies consider discretionary development approvals such as rezoning requests.

The Community Redevelopment Act of 1969, Chapter 163 Part III, Florida Statutes, sets forth required contents of the community redevelopment plan for East Fort Myers, along with the adoption process to be followed. The East Fort Myers Community Redevelopment Area was established by Ordinance 3401 and Resolution 2007-30 on May 21, 2007, following the adoption of a redevelopment plan and redevelopment trust fund. It was understood at the time that further input from the East Fort Myers community, along with a vision of what this area could become in the future, were needed. The Dover, Kohl & Partners team was later selected to refine and solidify a more detailed and wide-ranging plan. It is the intent that this plan will be adopted as a modification to the existing May 2007 East Fort Myers Revitalization and Redevelopment Plan in accordance with Chapter 163, replacing the former plan in its entirety.

A primary advantage to the establishment of a community redevelopment area is the City's ability to use a funding source called *Tax Increment Financing* (TIF). TIF dollars result from increases in taxable values from the year the redevelopment area was established (2007) to each later year. As new development occurs, tax monies from both the City and Lee County are funneled back into the neighborhood for improvements that will continue to raise the taxable values in the future.

The vision for the long-term is a vibrant and culturally diverse area with residential densities and commercial intensities that are consistent with a transect-based approach to land development in the City of Fort Myers. As many charrette participants pointed out, East Fort Myers' location between Downtown and I-75 is probably one of its most important attributes. Downtown is being developed as the pre-eminent regional center of Fort Myers, with residential densities of up to 100 units per acre and building heights of up to 32 stories along the Caloosahatchee River.

ACTION STEP # 16
ADOPT THE 2008 EAST FORT MYERS REVITALIZATION AND REDEVELOPMENT PLAN

The City of Fort Myers should ensure that the community vision recorded in this document is implemented by adopting the 2009 East Fort Myers Revitalization and Redevelopment Plan as the new redevelopment plan under Chapter 163, Part III. This document expands on the recommendations started in the former (2007) version and provides more detailed implementation strategies.

Next to Downtown, at the western terminus of the East Fort Myers Redevelopment Area, the Oasis was originally proposed to be a series of five high-rise condominiums along the river. Two have recently been completed. Despite the City's approval of the Oasis project, it is not envisioned that the march of the high-rises will continue eastward along the river, competing with downtown development and overwhelming neighborhoods further to the east.

However, the intensity of new development in much of East Fort Myers should be higher than in other parts of Fort Myers, and development regulations should allow a greater mix of uses and housing types to accommodate a variety of residents and employees. Where this plan recommends densities that exceed the maximums that are currently permitted in any part of East Fort Myers, the Comprehensive Plan will need to be amended accordingly before the higher densities can be allowed. This is due to the state's requirement that redevelopment plans cannot be inconsistent with Comprehensive Plans.

Implementation Issues

During the charrette process, it became abundantly clear that the two overriding immediate community complaints are the new medians along Palm Beach Boulevard and public safety concerns, which are exacerbated by the overgrown vegetation and lack of lighting along the railroad tracks that bisect part of East Fort Myers. Hopefully, these issues can be addressed in the near term, with modifications to the medians as proposed in this plan, combined with cleanup of the tracks and additional police presence in the area.

While the resolution of the median issue is expected to be paid for with additional Florida Department of Transportation funds, a new funding source could address crime and public safety. Tax increment funds can legally be used for such activities, if they become available.

Real estate market conditions in Fort Myers, as in most of Florida, have seriously declined in the past three years and are not expected to improve significantly for at least 18 months or longer. The consequences of this market recession are that taxable values are declining throughout Lee County, by as much as 20%. New developments such as the Oasis, which were expected to drive much of the initial increase in TIF dollars for East Fort Myers, have put future expansion on hold until the market improves. The TIF funding projections set forth in the adopted 2007 East Fort Myers Revitalization and Redevelopment Plan anticipated approximately \$15 million in funding over the next five years. Those figures are no longer realistic.

The advantage to having a plan in place during a market recession is that the development pressure to build bigger and taller is reduced in the short-term, allowing the City to focus on its real goals for this community. As all real estate values are cyclical, the time is right to develop a plan for East Fort Myers with realistic future expectations. Conditions will improve and taxable values will increase in the long-term. By statute, a redevelopment area is allowed to remain in place for 30 years.

Paying for Public Improvements

A primary advantage to the establishment of a community redevelopment area is the city's ability to use TIF funding, but these funds are not the only sources available for revitalizing East Fort Myers. One source is the potential for designating the railroad tracks and surrounding properties as a "brownfield" area. Brownfield sites are generally abandoned, idled, or underused industrial and commercial properties where expansion or redevelopment is complicated by real or perceived environmental contamination. Federal and state funds are and will be available for the reuse and redevelopment of such sites.

Other potential sources for improvements to East Fort Myers include:

- Enterprise Zone funds for certain business activities.
- Affordable housing monies such as HOPE, SHIP, and Community Development Block Grants (CDBG).
- Lee County Conservation 20/20 funds (which were recently used to acquire land for the Billy's Creek filter marsh).
- Florida Department of Transportation funds for median adjustments on Palm Beach Boulevard.
- Committed Fort Myers funds for landscaping and pedestrian improvements on Palm Beach Boulevard.
- Federal and state grants for park improvements.
- Street and sidewalk special assessments for neighborhood improvements such as drainage, street trees, street lighting, and sidewalks.
- Neighborhood Stabilization Program funds from the federal Housing and Economic Recovery Act of 2008.

ACTION STEP # 17 BROWNFIELD STATUS

The City and its Brownfield Advisory Board should facilitate the brownfield designation process for the railroad tracks and surrounding properties by:

- Working with the Seminole Gulf Railway to establish near-term rail improvements such as lighting and vegetation cleanup and the long-term objective of restoring passenger rail service in Fort Myers;
- Working with private property owners adjacent to the railroad tracks to encourage commercial and residential redevelopment in concert with this plan;
- Following designation by the City Council, owners of these brownfield properties will be eligible for a variety of economic incentives to implement plan recommendations.

Tax Increment Financing

Tax Increment Financing (TIF) results from increases in taxable property values between the year that the redevelopment area was established (2007 for East Fort Myers) and all later years. As property values increase, the extra property taxes on the increase (from both the city and Lee County) are segregated to be used for neighborhood improvements that will continue to raise taxable values in the future. Near the western end of East Fort Myers sits the first two Oasis towers along the river, containing 429 units, at an initial value in the \$200 million range. The units in Tower 2 appeared on the tax rolls in June 2009, providing some TIF funding for improvements in the redevelopment district for the 2009/2010 fiscal year. Towers 3, 4, and 5 in the Oasis have been put on hold until the real estate market improves.

The former TIF projections anticipated approximately \$15 million in funding over the next five years. Revised projections are provided on the following page; they have been substantially reduced in response to the continuing market decline. Real estate cycles are inevitable; planning for East Fort Myers must accommodate these changes and adjust to realistic future expectations. Conditions will improve at some point and taxable values will begin to increase again. The problematic conditions in East Fort Myers did not emerge overnight and they will not be corrected within the next couple of years. Patience accompanied by unrelenting persistence is the most realistic approach to implementing this plan.

The original CRA plan was adopted in 2007, so the “base year” for calculation of tax increment funds is 2007, when the taxable value of East Fort Myers totaled \$336,451,130. This is the figure that will be used consistently to determine whether tax increment funds will be available for East Fort Myers in any given year.

In 2008, the total taxable value of all property in East Fort Myers dropped by 14% to \$288,067,930, which means that there was no tax increment in the first year of the redevelopment area. In 2009, taxable value of existing property fell by another 7% (\$22,800,700), but new construction added \$112,584,830 (primarily 241 condo units at Oasis Tower 2). The net effect was to increase the preliminary 2009 taxable value in East Fort Myers to \$377,852,060. Because this total is higher than the 2007 base year, TIF funds in the amount of \$434,700 are anticipated during fiscal year 2009/2010.

The combined effect of the failing local real estate market and the national financial meltdown makes it extremely difficult to forecast anticipated tax increment revenues for East Fort Myers. Most likely, the influx of new development into the area (with the exception of Oasis Tower 1, which should appear on the 2010 tax roll) will be delayed for at least several years. At the same time, the taxable values of existing homes and businesses will probably continue to decline before they level off. To assess various financial scenarios, this report presents three different projections of East Fort Myers TIF potential over the next 6 years.

None of these projections anticipate substantial new construction in the district within the next five years beyond the Oasis Towers 1 and 2. The actual TIF dollars that may accrue to the East Fort Myers CRA are almost entirely attributable to the construction of the Oasis, whose initial value should be high enough to overcome the decline in value of existing properties. The taxable value Oasis Tower 2 began this year at \$111,500,000 but is expected to decrease due to poor sales. The initial taxable value of Oasis Tower 1 will probably be significantly lower than Tower 2. Unless Oasis values stabilize quickly, TIF funds for East Fort Myers could disappear in the near future. The details of these revenue projections are provided below, in the box entitled “Assumptions for the Range of TIF Projections.”

Assumptions for the Range of TIF Projections

Projection #1 – The Most Conservative Scenario – assumes the most drastic drop in existing real estate values, with a 20% drop in 2010, followed by a 10% drop in 2011, a 5% drop in 2012, then remaining steady. Oasis Tower 1 would appear on the tax roll in 2010 with a value of \$45 million. Oasis Tower 2 would decrease by 60% in 2010. In 2011, all Oasis units would decrease by 40%, then remain steady.

Projection #2 – The More Probable Scenario – assumes a 10% drop in taxable values of existing real estate in 2010, a 5% drop in 2011, then remaining steady. Oasis Tower 1 would appear on the tax roll in 2010 with a value of \$65 million. Oasis Tower 2 would decrease by 40% in 2010. In 2011, all Oasis units would decrease by 25%, then remain steady.

Projection #3 – The Most Optimistic Scenario – assumes a 5% drop in taxable values of existing real estate in 2010, then remaining steady. Oasis Tower 1 would appear on the tax roll in 2010 with a value of \$90 million. Oasis Tower 2 would decrease by 20% in 2010. In 2011, all Oasis units would decrease by 10%, then remain steady.

Fiscal Year	PROJECTION #1 CONSERVATIVE SCENARIO		PROJECTION #2 MOST PROBABLE SCENARIO		PROJECTION #3 OPTIMISTIC SCENARIO	
	Projected District Value	Projected TIF Revenue	Projected District Value	Projected TIF Revenue	Projected District Value	Projected TIF Revenue
FY 2009/2010	\$377,852,060	\$434,700	\$377,852,060	\$434,700	\$377,852,060	\$434,700
FY 2010/2011	\$302,247,716	\$0	\$371,291,405	\$365,815	\$432,071,733	\$1,003,994
FY 2011/2012	\$245,012,765	\$0	\$326,216,655	\$0	\$414,064,946	\$814,927
FY 2012/2013	\$235,463,145	\$0	\$326,216,655	\$0	\$414,064,946	\$814,927
FY 2013/2014	\$235,463,145	\$0	\$326,216,655	\$0	\$414,064,946	\$814,927
FY 2014/2015	\$235,463,145	\$0	\$326,216,655	\$0	\$414,064,946	\$814,927
Cumulative TIF		\$434,700		\$800,515		\$4,698,402

The most probable scenario places the anticipated TIF funds at about \$800,000 over this year and next year, at which point no further TIF funds will be available.

Type of Forecast	Potential TIF Revenue Over Six Years (2009/10 -- 2014/15)
Conservative	\$434,700
Most Probable	\$800,515
Optimistic	\$4,698,402

Table 7.4

SUPPLEMENTARY FUNDING FOR BICYCLE PATROLS

Several of the other redevelopment districts overseen by the Fort Myers Community Redevelopment Agency are funding a six-man roving bike patrol unit to provide enhanced police protection to those districts. All redevelopment districts funding the bike patrol and receiving the services still receive the same core level of services the rest of the city receives; this bike patrol is an extra benefit of being located in the participating redevelopment districts, which include the downtown, Cleveland Avenue, Central, Velasco Village, and Dr. Martin Luther King Jr. districts.

The bike patrol team currently rotates their schedules between the five participating districts on a pro-rata basis, rotating the days and times they spend in each district. Each time has two officers and also has a patrol car at their disposal. The schedule for the bike patrol team is flexible, so that if they need to spend more time in a certain area to properly address a situation, they are able to do that. Members of the bike patrol stop by the various businesses to check in and develop a relationship with both the businesses and residents, who can later contact the bike patrol team directly. Benefits of such a program include increased chances for a business to succeed, the potential to revitalize and recruit new business to the corridor, reductions in crime rates, and an improved perception of safety in the redevelopment area.

When funds are available, the East Fort Myers redevelopment area needs to participate in this bike patrol program as well. This will probably necessitate adding two more police to the bike patrol unit. The expenses for two mid-level officers are estimated to be approximately \$175,000 per year with an additional \$70,000 in start-up costs for equipment.

HOUSING AND ECONOMIC RECOVERY ACT OF 2008

In response to the collapse of the housing market nationally, in July 2008 the U.S. Congress passed the Housing and Economic Recovery Act. One portion of the act allocated \$3.92 billion in emergency assistance grants to state and local governments with the greatest need for redevelopment of abandoned and foreclosed homes and residential properties.

Under this “Neighborhood Stabilization Program,” communities across the country were ranked according to the number of foreclosures, sub-prime mortgages, and homes in default or delinquency. Based on this ranking, the city of Fort Myers has qualified for a \$2,297,318 emergency grant; no local matching funds are required.

Fort Myers submitted its action plan to HUD by the December 1, 2008, deadline, specifying the proposed use of this emergency grant. The following uses are eligible:

- Establishing financial mechanisms for purchase and redevelopment of foreclosed homes.
- Purchasing and rehabilitating abandoned or foreclosed homes in order to sell, rent, or redevelop the property.
- Demolishing blighted structures.
- Redeveloping demolished or vacant properties.

All cities are required to give funding priority to areas of greatest need within the city, using the same criteria that determined the total amount of the grant (the number of foreclosures, sub-prime loans, and delinquencies). Cities can file an application for these funds independently or can cooperate with Cape Coral or Lee County in a joint application.

There are two important additional restrictions:

- The city must be able to use all of these funds within an 18-month period.
- The annual income of beneficiaries cannot exceed 120% of the area’s median income.

ACTION STEP #18 **HOUSING AND ECONOMIC RECOVERY ACT OF 2008**

East Fort Myers should remain a priority area for the city’s use of funds from the Neighborhood Stabilization Program.

The map on this page shows the latest data available to the city for the actual location of pending foreclosures in July 2008 (shown with red circles) and the approximate concentration of actual residents throughout the city (shown in tiny gray dots that represent 10 residents each).

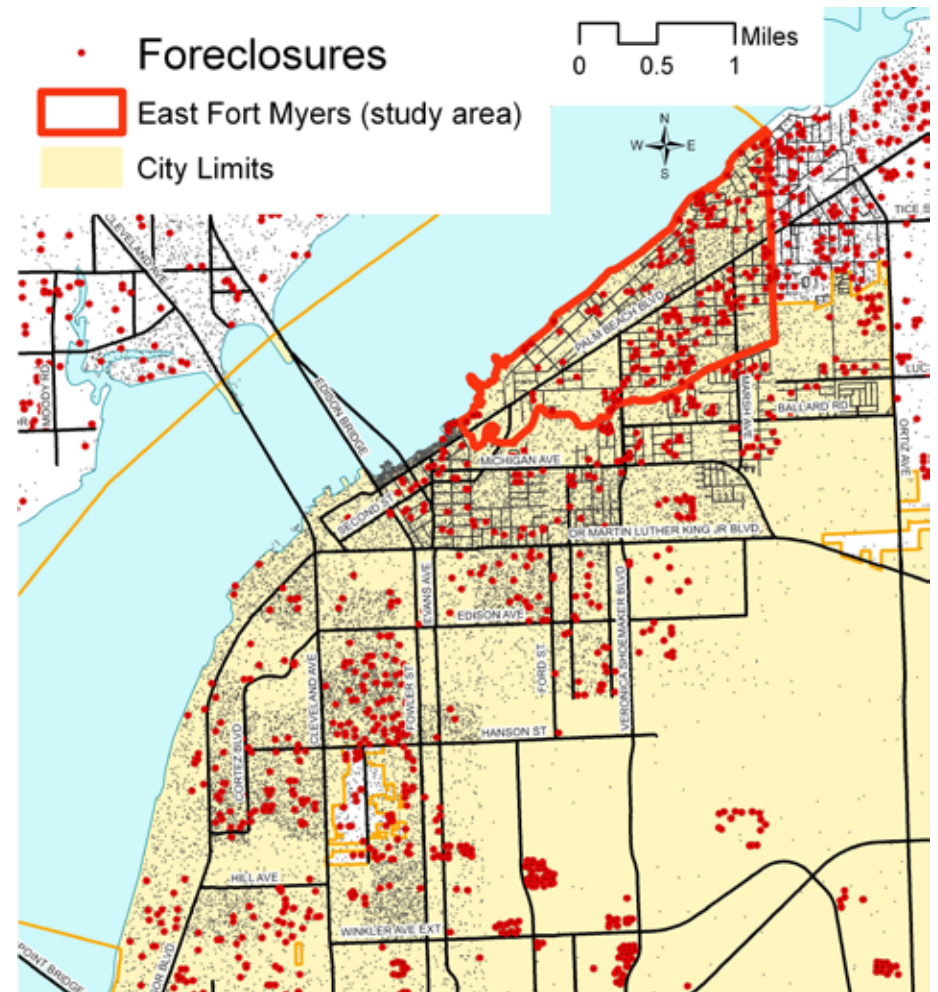

Figure 7.14

Recommended Funding Priorities

It is clear that the redevelopment needs greatly exceed anticipated funding levels and that this situation will continue indefinitely.

most likely to have the greatest effect on the revitalization of East Fort Myers with the smallest expenditures.

The first task in implementing this plan is to identify those action steps that can be carried out by city staff in the year immediately after adoption of this plan.

To assist the city in these tasks, Table 7.5 suggests an ambitious initial prioritization of the actions steps set forth in the plan.

The second task is to identify useful expenditures of public funds that are needed to begin carrying out additional recommendations and then select those that are

PROJECT	ACTION STEP #	SUGGESTED TIMEFRAME	LEAD AGENCY
Adopt the 2008 East Fort Myers Revitalization and Redevelopment Plan	16	0-1 year	City of Fort Myers
Amend the Comprehensive Plan as described in this report	1, 9, 10, 15	2-3 years	City of Fort Myers
Amend the Land Development Code as described in this report	1, 11, 15	3-4 years	City of Fort Myers
Improve neighborhood streets (sidewalks, street trees, drainage)	3, 7	3-20 years	City of Fort Myers
Publicize existing rehabilitation programs that help homeowners stabilize deteriorating structures	18	0-1 year	City of Fort Myers
Restore Billy's Creek and Coastal Mangrove Forests	8	ongoing	Friends of Billy's Creek, City of Fort Myers
Create trails and low-impact facilities for walking/jogging/kayaking along Billy's Creek	8	0-5 years	City of Fort Myers
Market Enterprise Zone and tap into Southwest Florida Enterprise Center	13,14	0-1 year	City of Fort Myers
Add programs at the Southwest Florida Enterprise Center to support emerging opportunities in the renewable energy field	14	0-1 year	Southwest Florida Enterprise Center
Landscape the medians and complete the pedestrian improvements on Palm Beach Boulevard	4	1-4 years	City of Fort Myers
Mow overgrown vegetation along the railroad tracks during the rainy season; add lighting near intersections	17	0-2 years	Seminole Gulf Railway or City of Fort Myers
Designate the railroad tracks and environs as a brownfield	17	2-3 years	City of Fort Myers
Reconfigure the new medians on Palm Beach Boulevard	4	1-4 years	MPO & Florida DOT
Acquire and improve land for park sites	2	ongoing	City of Fort Myers
Restore missing links in street grid	6, 7	ongoing	City of Fort Myers
Create a Riverwalk	1	2-5 years	City of Fort Myers
Lease or acquire railroad right-of-way to enable restoration of passenger rail service	5	5-10 years	Florida DOT

Table 7.5

PAGE LEFT INTENTIONALLY BLANK



appendix **A**

STATE-MANDATED CONTENTS OF A REDEVELOPMENT PLAN

Chapter 163.362 specifies the contents of a redevelopment plan. The text of the statute is shown below in *italics*, followed by the location in the redevelopment plan document where each of the required elements can be found – Shown in **Bold**.

163.362 Contents of Community Redevelopment Plan. Every community redevelopment plan shall:

1. Contain a legal description of the boundaries of the community redevelopment area and the reasons for establishing such boundaries shown in the plan.

See next page for legal description. This legal description is identical to the description used by the City of Fort Myers in Ordinance 3401 when the city established the East Fort Myers redevelopment area.

2. Show by diagram and in general terms:

(a) The approximate amount of open space to be provided and the street layout.
See maps and descriptions in Chapters 4, 5, and 6.

(b) Limitations on the type, size, height, number, and proposed use of buildings.

Limitations on type, size, height, number, and proposed use of buildings are governed by the Fort Myers Land Development Code.

(c) The approximate number of dwelling units.

It is anticipated that the number of dwelling units in East Fort Myers area will increase. The 2000 Census reported 2,694 existing units. The major change since that time has been new condominiums (Alta Mar and the first two towers at the Oasis), totaling 560 additional units. The expected future total is between 4,000 and 5,000 dwelling units.

(d) Such property as is intended for use as public parks, recreation areas, streets, public utilities, and public improvements of any nature.

See maps and descriptions in Chapters 4, 5, and 6.

3. If the redevelopment area contains low or moderate income housing, contain a neighborhood impact element which describes in detail the impact of the redevelopment upon the residents of the redevelopment area and the surrounding areas in terms of relocation, traffic circulation, environmental quality, availability of community facilities and services, effect on school population, and other matters affecting the physical and social quality of the neighborhood.

East Fort Myers contains a substantial stock of housing for persons and families with low and moderate incomes. Proposed improvements to East Fort Myers to benefit these residents are described throughout this plan.

4. Identify specifically any publicly funded capital projects to be undertaken within the community redevelopment area.

Potential capital projects are described in action steps 1, 2, 3, 4, 6, 7, and 8.

5. Contain adequate safeguards that the work of redevelopment will be carried out pursuant to the plan.

This plan for East Fort Myers plan was prepared using the extensive public participation process described in Chapter 2. Redevelopment will occur in accordance with the Fort Myers Comprehensive Plan and Land Development Code, as amended from time to time. This plan contains recommendations for changes to both documents, which will be considered through the statutory public hearing processes.

6. Provide for the retention of controls and the establishment of any restrictions or covenants running with land sold or leased for private use for such periods of time and under such conditions as the governing body deems necessary to effectuate the purposes of this part.

Not applicable to East Fort Myers. This is a plan for existing neighborhoods; large parcels of public property will not be sold or leased for private use. Should any parcels be sold or leased, Fort Myers and its CRA will follow its standard developer agreement process to ensure the retention of controls over public land.

7. Provide assurances that there will be replacement housing for the relocation of persons temporarily or permanently displaced from housing facilities within the community redevelopment area.

The City Fort Myers and its East Fort Myers CRA will follow all applicable statutory requirements if relocation of residents is required.

8. Provide an element of residential use in the redevelopment area if such use exists in the area prior to the adoption of the plan or if the plan is intended to remedy a shortage of housing affordable to residents of low or moderate income, including the elderly, or if the plan is not intended to remedy such shortage, the reasons therefor.

Residential uses take place on a majority of land within the East Fort Myers CRA and will continue to do so in the future.

9. Contain a detailed statement of the projected costs of the redevelopment, including the amount to be expended on publicly funded capital projects in the community redevelopment area and any indebtedness of the community redevelopment agency, the county, or the municipality proposed to be incurred for such redevelopment if such indebtedness is to be repaid with increment revenues.

In plan included with various Action Steps. Also see Also see the discussion in Chapter 7 on redevelopment financing.

10. Provide a time certain for completing all redevelopment financed by increment revenues. Such time certain shall occur no later than 30 years after the fiscal year in which the plan is approved, adopted, or amended pursuant to s. 163.361(1). However, for any agency created after July 1, 2002, the time certain for completing all redevelopment financed by increment revenues must occur within 40 years after the fiscal year in which the plan is approved or adopted. **All redevelopment in East Fort Myers that is financed by increment revenues shall occur no later than December 2038.**

Legal Description of East Fort Myers Redevelopment Area

East Fort Myers Redevelopment Area: A parcel of land in Lee County, Florida, Beginning at the intersection of Marsh Ave. and Billy's Creek south Westerly along Billy's Creek to the intersection of Billy's Creek and First St. Continuing from the intersection of Billy's Creek and First St. toward the river an continue in North Westerly direction. Then follow the river in the N Easterly direction to the intersection of the river and the city limit boundary. Then following the city limit boundary in southerly direction until it intersects with Woodside Ave. the west of Woodside Ave. to the intersection of Woodside Ave. and Marsh. South of Marsh Ave. to the intersection of Marsh Ave. and Billy's Creek back to P.O.B.

*Subject to easements, restrictions, reservations, and rights of way of Record.

SOURCE: Fort Myers Ordinance 3401



East Fort Myers Redevelopment Area

PAGE LEFT INTENTIONALLY BLANK



appendix **B**

WARDS OF EAST FORT MYERS

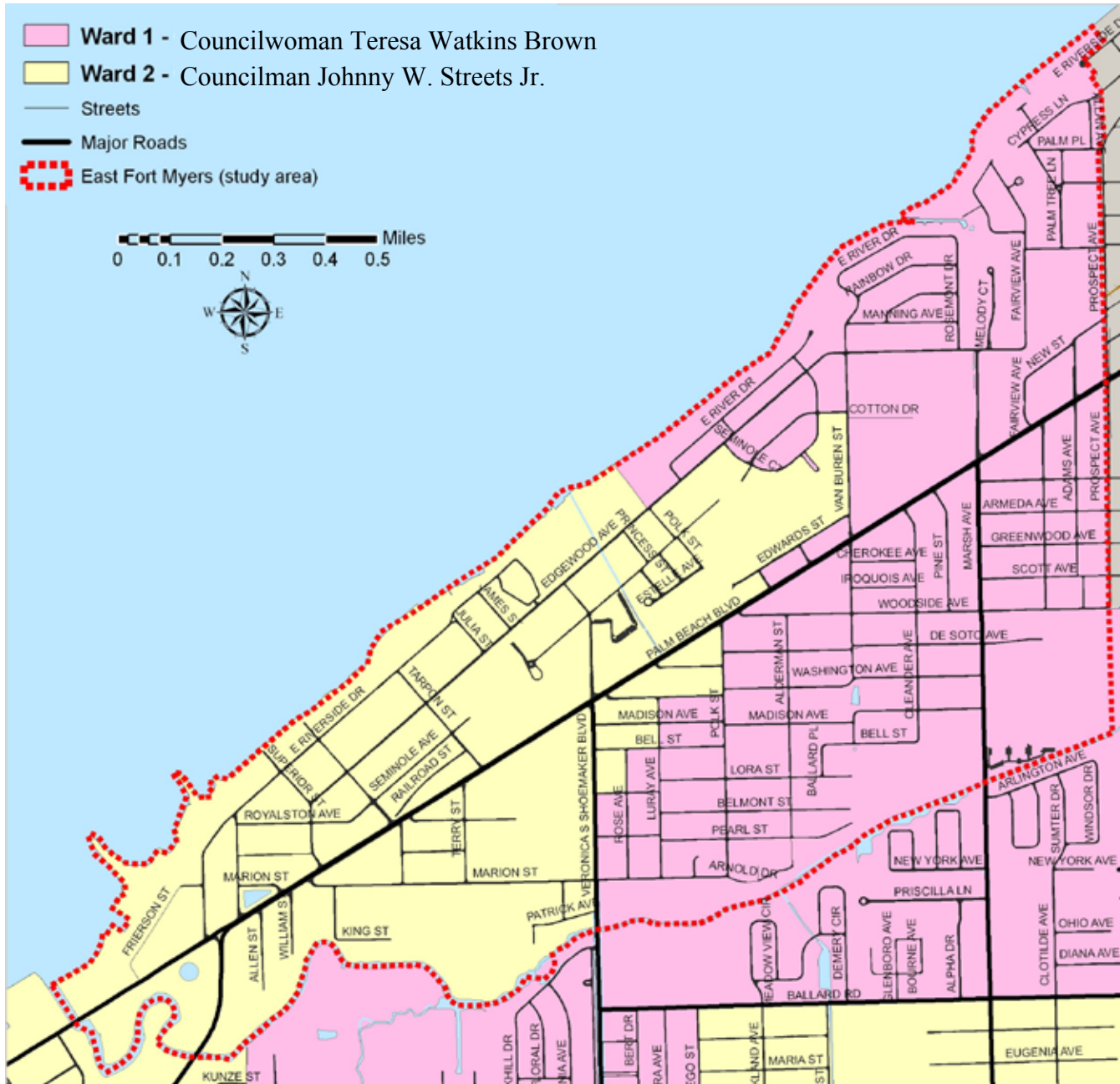



appendix **C**

ENTERPRISE ZONE



enterprise zone

OVERVIEW

This brochure is provided by the Economic Development Office (EDO) of Lee County to assist business owners in their efforts to take advantage of the Enterprise Zone refund or exemption benefits. The brochure is for general reference only and not intended to include all statutory or business requirements.

What is the Enterprise Zone?

An Enterprise Zone, designated by the State of Florida, is an area targeted for economic revitalization. Investing capital and creating jobs in a Zone provides the foundation for revitalizing the quality of life in Florida's distressed communities. The State of Florida has developed the Enterprise Zone Program through which it offers state tax incentives to eligible companies.

What benefits are offered in the Enterprise Zone?

The State of Florida's Enterprise Zone Program consists of six tax credits against corporate income taxes and state sales taxes. Job credits, applicable to either corporate income or state sales taxes, are available for eligible companies who hire Zone residents. Community contribution tax credits against

corporate income taxes are available for cash and specified goods donated to eligible sponsors. Property tax credits up to \$50,000 are available against corporate income taxes for new or rehabilitated commercial construction. Sales tax is refunded for business machinery and equipment which is used exclusively in a Zone. Finally, building materials state sales tax refunds, and utility tax exemptions (municipal utility and state sales tax) are also available.

Where is the Enterprise Zone?

The Enterprise Zone is a 9.68 square mile area within the boundaries of the City of Fort Myers and Lee County. A map of the boundaries of the area are located in this brochure or can be found on the EDO Web site www.LeeCountyBusiness.com

When can I apply?

The Fort Myers/Lee County Enterprise Zone was reauthorized effective January 1, 2006, and is in effect for 10 years. Most of the tax savings require that part-time or full-time, permanent employees be employed for at least three calendar months before the business is eligible to receive benefits. However, you don't need to employ any Zone residents to qualify for other refunds. Machinery and equipment sales tax refunds must be filed within six months of invoice.

How do I apply?

The Fort Myers/Lee County Enterprise Zone Coordinator certifies all applications for the Zone refund programs. For applications and more information, contact the Economic Development Office of Lee County at (239) 338-3161 or visit the State Web site at www.floridaenterprisezone.com to download forms.

BENEFITS SUMMARY

Sales & Use Tax Credit for Job Creation

Allows businesses located in a Zone that collect and pay sales and use tax, a credit against sales tax due.

This credit is for wages paid to new employees who have been employed by the business for at least three consecutive months and are residents of a Zone (or welfare transition program participants who aren't required to live in the Zone to be eligible).

A new job must be created before the business earns a tax credit. New employees cannot be an owner, partner, or stockholder.

Sales Tax Refund for Business Machinery & Equipment

A refund is available for sales taxes paid on the purchase of certain business property, (e.g. tangible personal property such as office equipment, warehouse equipment, and some industrial machinery and equipment), which will be used exclusively in a Zone for at least three years and cost \$5,000 or more.

Sales Tax Refund for Building Materials

A refund is available for sales taxes paid on the purchase of building materials used to rehabilitate or build on real property located in a Zone. Incentives are limited to owners and lessees of the real property that is newly constructed or rehabilitated within the Zone.

Refunds are available only one time per parcel of real estate, unless there is a change in property ownership or leasing arrangements.



Sales Tax Exemption for Electrical Energy Used

A 100% sales tax exemption is available if 20% or more of the permanent, full-time employees are residents of the Zone. A 50% sales tax exemption is available if less than 20% of the permanent, full-time employees are residents of the Zone.

Eligible businesses are: (1) businesses located in a newly occupied structure; (2) renovated structure (no electrical service for three months); or (3) has received a building materials sales tax refund.

Available only to businesses located in the City of Fort Myers portion of the Zone.

Corporate Income Tax Credit for Job Creation

Allows businesses located in a Zone who pay state corporate income tax an income tax credit for wages paid to new employees who have been employed by the business for at least three consecutive months and are residents of a Zone (or are welfare transition program participants who don't have to live in the Zone to be eligible).

A new job must be created before the business earns a tax credit.

Corporate Income Tax /Credit for Property Tax

New or expanding businesses located in a Zone are allowed a tax credit against Florida corporate income tax equal to 96% of ad valorem taxes paid on the new or improved property. Five or more new full-time jobs must be established to qualify.

Corporate Income Tax Credit for Community Contributions

Allows businesses anywhere in Florida a 50% credit on Florida corporate income tax, insurance premium tax or sales tax refund for donations to local community development projects

located within a Zone. Donations must be made to an eligible sponsor conducting an approved community development project.

The annual amount of credit granted is limited to \$200,000 per firm and \$12,000,000 statewide.

Local Incentives

City of Fort Myers Business Tax Receipt (formerly occupational license)

Allows any business, occupation or profession located in the City of Fort Myers portion of the Zone to receive a 50% reduction of the business tax receipt each year.

City of Fort Myers Water & Sewer Impact Fee Waiver (Residential)

Allows for any new construction for a residential dwelling located in the City of Fort Myers portion of the Zone to receive a waiver of the water and sewer impact fees.

Lee County Impact Fee Waivers (Residential)

Allows for any new construction for a residential dwelling located in the City of Fort Myers portion of the Zone to receive waivers of impact fees for community parks, EMS, fire, regional parks, & roads.

Lee County Property Tax Exemption for Child Care Facility

Any real estate used and owned as a child care facility which operates in an Enterprise zone is exempt 100% from property tax. Child care facility operators must hold a current license by the Florida Department of Children and Families or local licensing authority. Application for Exemption Certification must be submitted to the Enterprise Zone Coordinator on or before February 1 of each year for which exemption is claimed.

Economic Development Office of Lee County

12800 University Drive, Suite 300
Fort Myers, FL 33907
239.338.3161
fax 239.338.3227
E-mail address: EDO@leegov.com
www.LeeCountyBusiness.com
www.floridaenterprisezone.com

Economic Development Office
of Lee County
12800 University Drive, Suite 300
Fort Myers, FL 33907



Fort Myers/Lee County
enterprise zone



PAGE LEFT INTENTIONALLY BLANK



appendix **D**

EAST FORT MYERS ECONOMIC DEVELOPMENT RESEARCH SURVEY

(Researcher _____)

This research is designed to collect information from area residents and businesses that will be used solely to develop an economic development plan for East Fort Myers.

Your participation is very important, since your ideas will drive the type of community development activities recommended. Your willing response, and the quality of your answers, will significantly impact the quality of this community in the years ahead. Thus, please be thoughtful, honest, and compete with your responses.

Though the project sponsor is the City of Fort Myers, the information is being collected by Professor Lee R. Duffus of Florida Gulf Coast University, and will only be available to the city or other agencies in summarized form. In other words, individual participants will not be identifiable from the information given.

Please do not write your name on this questionnaire. No names or other ways to identify individual participants is being collected.

Thank you for you for participating in this research.

Lee R. Duffus, Ph.D. (239-839-1305)

1. Identify three features of East Fort Myers that positively impact its quality of life (Circle the three features or write-in in "Other" below).

- a. Crime/crime rate
- b. Concentration of immigrants
- c. Road/traffic conditions
- d. Language barrier of some residents
- e. Business friendly environment
- f. Access to Interstate 75
- g. Access to shopping/retail services
- h. Access to good schools/quality education
- i. Organized and involved business community
- j. Organized and involved residential community
- k. Open spaces/community parks
- l. Proximity to downtown Fort Myers
- m. Access to sports/recreational/athletic activities
- n. Availability of jobs/employment opportunities
- o. Stable neighborhoods
- p. Cultural diversity
- q. Availability of public transportation
- r. Multiple families in single family homes
- s. Dirty streets/yards
- t. Adequacy of policing
- u. Quality of retailing
- v. Easy access to government/public services
- w. Access to fire/ambulance services
- x. Access to riverfront activities
- y. Family friendly environment
- z. Access to social/cultural/community activities
- a1. New/used automobile lots
- a2. Affordability of housing
- a3. Sensitivity of City/County staff
- a4. Access to services, police, medical, etc)
- a5. Other: _____

2. Identify three features of East Fort Myers that negatively impact its quality of life (Circle the three features or write-in in "Other" below).

- a. Crime/crime rate
- b. Concentration of immigrants
- c. Road/traffic conditions

- d. Language barrier of some residents
- e. Business friendly environment
- f. Access to Interstate 75
- g. Access to shopping/retail services
- h. Access to good schools/quality education
- i. Organized and involved business community
- j. Organized and involved residential community
- k. Open spaces/community parks
- l. Proximity to downtown Fort Myers
- m. Access to sports/recreational/athletic activities
- n. Availability of jobs/employment opportunities
- o. Stable neighborhoods
- p. Cultural diversity
- q. Availability of public transportation
- r. Multiple families in single family homes
- s. Dirty streets/yards
- t. Adequacy of policing
- u. Quality of retailing
- v. Easy access to government/public services
- w. Access to fire/ambulance services
- x. Access to riverfront activities
- y. Family friendly environment
- z. Access to social/cultural/community activities
- a1. New/used automobile lots
- a2. Affordability of housing
- a3. Sensitivity of City/County staff
- a4. Access to services, police, medical, etc)

3. Please list three types of business activities (for example: pawn shop, dollar store) not currently located in East Fort Myers that you would support if located here (Circle the three most important features, or write-in in “Other” below).

- a. National brand hotel
- b. Movie house
- c. Performing Arts Center
- d. High end family restaurants
- e. Funeral services
- f. Bookstore
- g. Other _____

4. Please identify or list the types of social/cultural/recreational/sports (for example: plays, movies, community soccer, dances, music festivals) activities that you think would improve the quality of life in East Fort Myers (Circle as many as apply, or write-in your choices in “Other” below).

- a. Youth center
- b. Symphony/music/concerts/arts
- c. Child care services
- d. Cultural programs
- e. Kids' activities
- f. Cinema/movie house
- g. Recreational activities
- h. Sports stadium
- i. Water-related parks
- j. Trails for biking/walking/physical fitness, etc.
- k. Other _____

5. Identify the one economic or socio-cultural activity (don't worry about the cost of providing it) that you would most like to see located in East Fort Myers (Circle the one that apply, or write it in “Other” below).

- a. Cinema/movie house
- b. Cultural/civic center
- c. Banks
- d. Upscale retailing
- e. Riverfront parks
- f. More jobs nearby
- g. Law enforcement/police station
- h. Safe pedestrian crossings
- i. Buildings with apartments above commercial/retail activities
- j. Housing that overlooks the street, instead of garage in front
- k. Child-centered parks
- l. Public/government service buildings
- m. Other _____

Background Information

This information will be used solely to develop demographic profile of the community. No names or other identifying information is collected, and all data be aggregated. Individual participants will not be identifiable from the information given.

6. Gender of participant:

- a. Male
- b. Female

7. How long have you lived in East Fort Myers? (EFM)

- a. I do not live in EFM
- b. Less than 2 years
- c. 2- 4 years
- d. 5-7 years
- e. 8-10 years
- f. 11-15 years
- g. 16-20 years
- h. Over 20 years

8. How many adults live in your household?

- a. 1 adult
- b. 2 adults
- c. 3 adults
- d. 4 adults
- e. 5 adults
- f. More than 5 adults

9. Number of children in the household:

- a. No children
- b. 1-2 children
- c. 3-4 children
- d. 5-6 children
- e. More than 6 children

10. Type of your employment?

- a. Unemployed/disabled
- b. Retirees
- c. Maintenance (gardening, household, etc.)
- d. Public security (police, security guard, etc)
- e. Personal-Care Services (hairdresser, barber, etc.)
- f. Housework (homemakers, residential cleaning, etc.)
- g. Medical/health services (doctor, nurse, etc.)
- h. Educational services(teachers, day care, etc)
- i. Clerical services (secretarial, office, bookkeeping, etc.)
- j. Management (managers, president, supervisors, etc.)
- k. Engineering/Professional services (architect, etc.)
- l. Construction services (electrical, plumbing, etc.)
- m. City and County staff/officials
- n. Other _____

11. To which of the following age-groups do you belong?

- a. Under 18 years
- b. 18-25 years
- c. 26-30 years
- d. 31-35 years
- e. 36-40 years
- f. 41-45 years
- g. 46-50 years
- h. 51-55 years
- i. 56-60 years
- j. 61-65 years
- k. Over 65 years

12. Racial/Ethnic origin?

- a. White/Caucasian
- b. Black/African American
- c. Hispanic/Latino
- d. Native-American
- e. Asian
- f. Other

13. Highest education attained by head of household?

- a. Less than High School
- b. Some high school
- c. High School graduate
- d. Occupational/technical training
- e. Some college
- f. 2-year college graduate
- g. 4-year college graduate
- h. Post graduate

14. If you live in East Fort Myers (EFM), is the home in which you live family owned or rented?

- a. Family owned
- b. Rented or owned
- c. Not applicable

15. If you live in EFM, do you live in a: (circle all that apply)

- a. Apartment house
- b. Rooming House (where you rent a room)
- c. Condominium
- d. A home in which you are a non-paying guest
- e. Single family house
- f. Manufactured home/Trailer
- g. Duplex
- h. Other _____

16. Your involvement with the East Fort Myers (EFM) community is based on? (circle all that apply)

- a. Ownership of property in EFM
- b. Representation of EFM property owner(s)
- c. Ownership of business in EFM
- d. Residence in EFM
- e. Employed in EFM
- f. Your perception of what is best for EFM development
- g. Other _____

17. Estimated weekly household Income?

- a. Under \$240
- b. \$240-320
- c. \$321-400
- d. \$401-600
- e. \$601-800
- f. \$801- 1200
- g. \$1201-1600
- h. \$1601-2000
- i. Over \$2000

18. Estimated weekly household expenditure (including, food, recreation, transportation, clothing, rent/mortgage, etc)?

- a. Under \$100
- b. \$100-250
- c. \$251-500
- d. \$501-750
- e. \$751-1000
- f. \$1001- 1500
- g. \$1501-2000
- h. Over \$2000

Thank you for participating in this very important survey of your community.

ENCUESTA DE DESARROLLO ECONÓMICO DEL ESTE DE FORT MYERS

(Encuestador _____)

Esta encuesta fue diseñada con el propósito de obtener información de los residentes y comerciantes del Este de Fort Myers y será utilizada únicamente con la intención de diseñar un Plan de Desarrollo Económico para tu comunidad.

Tu participación en esta encuesta es muy importante y valiosa; las ideas e información que se obtengan de este cuestionario servirán de recomendaciones para el desarrollo de tu comunidad. Tus respuestas y la calidad de las mismas tendrán un impacto significativo en tu comunidad en los próximos diez años. Deseamos que respondas a cada una de las preguntas con honestidad y con tu mejor conocimiento sobre el tema.

Este proyecto está auspiciado por el Gobierno de la Ciudad de Fort Myers pero la encuesta y la información que se obtenga de la misma será manejada por el profesor Lee R. Duffus del Florida Gulf Coast University. Toda la data de esta encuesta se presentará solamente de forma resumida al gobierno municipal así como a otras agencias; nadie podrá identificar tus respuestas.

Por favor no escribas tu nombre en este cuestionario. Para este cuestionario no deseamos obtener ninguna información que identifique a los participantes.

Gracias por participar en este proyecto.

Dr. Lee Duffus, Ph.D. (239-839-1305).

1. Identifica tres características del Este de Fort Myers que tienen un impacto positivo en la calidad de vida en tu comunidad. (Marca con un círculo tus tres respuestas y/o escribe bajo "Otras" tu contestación)

- a. El crimen/la tasa criminal
- b. Concentración de inmigrantes
- c. Condiciones sobre el tránsito y carreteras
- d. Barreras con el idioma
- e. Cordial ambiente comercial
- f. Acceso a la Autopista 75
- g. Acceso a centros y establecimientos comerciales
- h. Acceso a buenas escuelas/ calidad educativa
- i. Comunidad comercial organizada y comprometida
- j. Comunidad residencial organizada y comprometida
- k. Áreas abiertas/ parques en la comunidad
- l. Proximidad al centro urbano de Fort Myers
- m. Acceso a deportes/ recreación /actividades deportivas
- n. Disponibilidad / Oportunidades de empleo
- o. Comunidades estables
- p. Diversificación cultural
- q. Acceso al transporte público
- r. Casas unifamiliares con varias familias
- s. Calles y patios sucios
- t. Adecuada vigilancia policial
- u. Calidad de los comercios
- v. Fácil acceso a servicios gubernamentales y servicios públicos
- w. Acceso al servicio de bomberos y ambulancias
- x. Acceso a actividades frente al río
- y. Cordial ambiente familiar
- z. Acceso a actividades sociales, culturales y comunales
- a1. Lotes de automóviles nuevos/ usados
- a2. Viviendas de precios razonables
- a3. Sensibilidad de empleados de la ciudad/ condado
- a4. Otras _____

2. Identifica tres características del Este de Fort Myers que tienen un impacto negativo a la calidad de vida en tu comunidad. (Marca con un círculo tus tres respuestas y/o escribe bajo "Otras" tu contestación)

- a. El crimen/la tasa criminal
- b. Concentración de inmigrantes
- c. Condiciones sobre el tránsito y carreteras

- d. Barreras con el idioma
- e. Cordial ambiente comercial
- f. Acceso a la Autopista 75
- g. Acceso a centros y establecimientos comerciales
- h. Acceso a buenas escuelas/ calidad educativa
- i. Comunidad comercial organizada y comprometida
- j. Comunidad residencial organizada y comprometida
- k. Áreas abiertas/ parques en la comunidad
- l. Proximidad al centro urbano de Fort Myers
- m. Acceso a deportes/ recreación /actividades deportivas
- n. Disponibilidad / Oportunidades de empleo
- o. Comunidades estables
- p. Diversificación cultural
- q. Acceso al transporte público
- r. Casas unifamiliares con varias familias
- s. Calles y patios sucios
- t. Adecuada vigilancia policial
- u. Calidad de los comercios
- v. Fácil acceso a servicios gubernamentales y servicios públicos
- w. Acceso al servicio de bomberos y ambulancias
- x. Acceso a actividades frente al río
- y. Cordial ambiente familiar
- z. Acceso a actividades sociales, culturales y comunales
- a1. Lotes de automóviles nuevos/ usados
- a2. Viviendas de precios razonables
- a3. Sensibilidad de empleados de la ciudad/ condado
- a4. Otras _____

3. Identifica tres tipos de negocios que en la actualidad no existen en el Este de Fort Myers pero que si existieran tu las frecuentarías y patrocinarías (por ejemplo casas de empeño, tiendas todo a dólar) (Marca con un círculo tus tres respuestas y/o escribe bajo “Otras” tu contestación)

- a. Hotel de cadena nacional
- b. Salas de cine
- c. Salas de teatro
- d. Librería
- e. Restaurantes familiares
- f. Servicios funerarios
- g. Otros _____

4. Por favor identifica o enumera el tipo de actividad social, cultural, recreativa y/o deportiva que tu entiendes mejorarían la calidad de vida en el Este de Fort Myers (por ejemplo funciones teatrales, cine, balompié para residentes de la comunidad, bailes, festivales musicales) (Marca con un círculo todas las respuestas y/o escribe bajo “Otras” tu contestación)

- a. Centro para la juventud
- b. Conciertos/ música /artes
- c. Servicios de cuidado para niños
- d. Programas culturales
- e. Actividades para niños
- f. Salas de cine
- g. Actividades recreativas
- h. Estadios deportivos
- i. Parques acuáticos
- j. Veredas para bicicletas, caminar y ejercitarse
- m. Otras _____

5. Identifica la única actividad económica o sociocultural que más desearías ver en el Este de Fort Myers. (no tomes en consideración el costo que conlleve traer esta actividad a la comunidad) (Marca con un círculo la respuesta y/o escribe bajo “Otras” tu contestación)

- a. Salas de cine
- b. Centro cultural/cívico
- c. Bancos comerciales
- d. Tiendas de lujo
- e. Parques frente al río
- f. Mayor disponibilidad de trabajos
- g. Vigilancia/ Cuartel de policía
- h. Caminos elevado sobre Palm Beach Boulevard
- i. Edificios con apartamentos sobre el área comercial
- j. Viviendas con vistas a la calle en vez de tener garajes en su patio frontal
- k. Parques para niños
- l. Edificios de gobierno y servicios públicos
- m. Otras _____

Información Demográfica

Esta información se utilizará únicamente con el fin de obtener las tendencias demográficas de la comunidad. No es necesario incluir tu nombre ni ninguna otra información que revele tu identidad; toda la información que se obtenga de cada cuestionario será resumida en un documento. Ningún participante podrá ser identificado con la información que ha suministrado

6. Sexo del participante:

- a. Masculino
- b. Femenino

7. ¿Cuanto tiempo has vivido en el Este de Fort Myers (EFM)?

- a. No vivo en EFM
- b. Menos de 2 años
- c. 2-4 años
- d. 5-7 años
- e. 8-10 años
- f. 11-15 años
- g. 16-20 años
- h. Más de 20 años

8. ¿Cuántos adultos viven en tu hogar?

- a. 1 adulto
- b. 2 adultos
- c. 3 adultos
- d. 4 adultos
- e. 5 adultos
- f. Más de 5 adultos

9. ¿Cuántos niños viven en tu hogar?

- a. Ninguno
- b. 1-2 niños
- c. 3-4 niños
- d. 5-6 niños
- e. 7-8 niños
- f. Más de 8 niños

10. ¿Cuál es el tipo de trabajo al cual te dedicas?

- a. Desempleado/ Incapacitado
- b. Desempleado/ Incapacitado
- c. Retirado/ Jubilado
- d. Mantenimiento (jardinería, limpieza, etc.)
- e. Seguridad pública (policía, guardia de seguridad, etc.)
- f. Servicios de cuidado personal (barbero, estilista, etc.)
- g. Labores en el hogar (ama de casa, limpieza residencial, etc.)
- h. Servicios médicos y de salud (doctores, enfermera(o) s, etc.)
- i. Servicios administrativos (secretaria(o) s, oficinistas, etc.)
- j. Gerencia (gerentes, presidentes, supervisores, etc.)
- k. Servicios profesionales (Ingeniero (a) s, arquitecto(a) s, etc.)
- l. Servicios en la industria de la construcción (electricistas, plomeros, etc.)
- m. Empleado de la Ciudad o del Condado/ Oficiales gubernamentales
- n. Otros _____

11. ¿Cual grupo representa tu edad?

- a. Menos de 18 años
- b. 18-25 años
- c. 26-30 años
- d. 31-35 años
- e. 36-40 años
- f. 41-45 años
- g. 46-50 años
- h. 51-55 años
- i. 56-60 años
- j. 61-65 años
- k. Más de 65 años

12. ¿Cuál es su raza/ Origen étnico?

- a. Blanco
- b. Africano-Americano
- c. Hispano/Latino
- d. Nativo-Americano
- e. Asiático
- f. Otra _____

13. ¿Cuál es el nivel educativo del jefe del hogar?

- a. Menos del nivel secundario
- b. Algún grado de nivel secundario
- c. Se graduó de nivel secundario
- d. Colegio técnico/ocupacional
- e. Algún grado de nivel universitario
- f. Se graduó en dos años de nivel universitario
- g. Se graduó en cuatro años de nivel universitario
- h. Doctorado/ Post Grado

14. Si vives en EFM, ¿el hogar en donde vives es de tu propiedad o es rentado?

- a. De mi propiedad
- b. Rentado
- c. No aplica

15. Si vives en EFM, ¿en que tipo de vivienda vives?: (marca con un círculo todas las respuestas que aplican).

- a. Casa de apartamentos
- b. Condominio
- c. Casa unifamiliar
- d. Casas gemelas/duplex
- e. Casas de huésped (en donde rentas un cuarto)
- f. En un hogar en donde vives como invitado sin pagar renta
- g. Casa manufacturada/ casa movable
- h. Otra _____

16. Tu relación con la comunidad del Este de Fort Myers se basa en: (marca con un círculo todas las que aplican).

- a. Dueño (a) de una propiedad en EFM
- b. Representante de propietario (a) en EFM
- c. Dueño (a) de negocio en EFM
- d. Residente en EFM
- e. Empleado en EFM
- f. Tu percepción de que debería ser lo mejor para el desarrollo de EFM
- g. Otra _____

17. ¿Cual es el ingreso semanal estimado en tu hogar?

- a. Menos de \$240
- b. \$240-320
- c. \$321-400
- d. \$401-600
- e. \$601-800
- f. \$801-1200
- g. \$1201-1600
- h. \$1601-2000
- i. Más de \$2000

18. ¿Cual es el gasto semanal estimado en tu hogar? (incluye comida, recreación, transportación, ropa, renta/ hipoteca)

- a. Menos de \$100
- b. \$101-250
- c. \$251-500
- d. \$501-750
- e. \$751-1000
- f. \$1001-1500
- g. \$1501-2000
- h. Más de \$2000

Gracias por tu participación en esta importante encuesta para tu comunidad.

PAGE LEFT INTENTIONALLY BLANK